

# Nv-Series and P-Series Catalog



Spring 2020







# Doing Our Part to Create a Better Future for All...

## Core Environmental Policy

The Mitsubishi Electric Group promotes sustainable development and is committed to protecting and restoring the global environment through technology, all business activities and the actions of our employees.

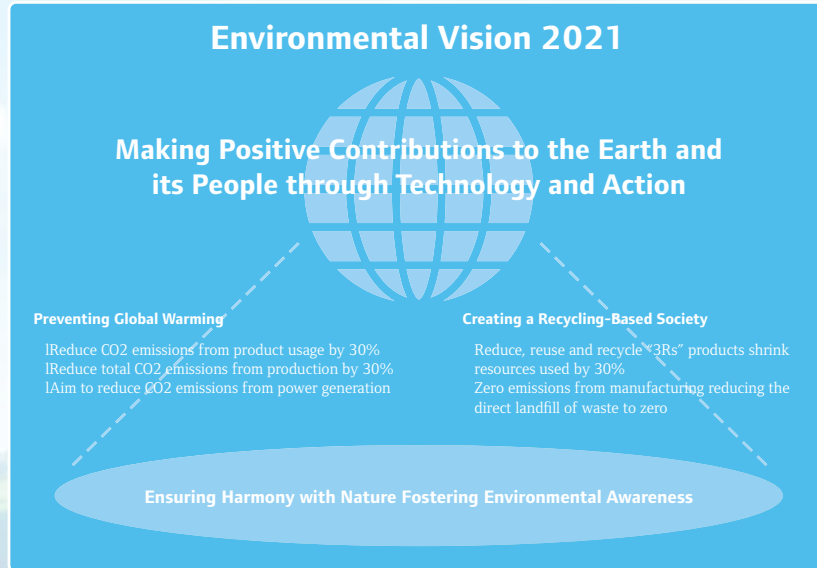

## Mitsubishi Electric reflects the essence of this policy and vision in all aspects of its air conditioner business.

### Preventing Global Warming

Heat pump technology inspires Mitsubishi Electric to design air conditioners that combine comfort and ecology.

Mitsubishi Electric develops technologies to balance comfort and ecology, achieving greater efficiency in heat pump operation.

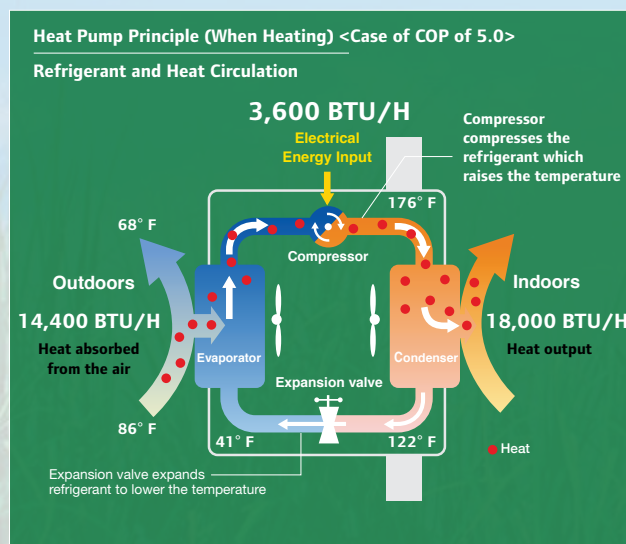

















	Comfort	Ecology
1. Inverter	Faster start-up and more stable indoor temperature than non-inverter units.	Fewer On/Off operations than with non-inverter saving energy.
2. 3D i-see Sensor*	Since the position of people can be detected, airflow can be set to personal selection, such as direct airflow path. The ability to adjust to individual preferences results in more comfortable air conditioning.	Since the number of people in a room can be detected, energy-saving operation is adjusted or the power is turned off automatically. Efficient air conditioning with less waste is realized.
3. Flash Injection	Achieves high heating capacity even at low temperatures plus faster start-up compared to conventional inverters.	Expands the geographical region covered by heat pump heating systems.





# CONTENTS

 Product Line-Up.....	6-11
 Quality and Testing.....	12-13
 Inverter Technologies.....	14-15
 Features.....	16-29
 Nv-Series.....	30-69
 P-Series.....	70-107
 Nv-Series Multi-zone Outdoor Units.....	108-115
 Conditions for Specifications.....	116
 Piping Installation.....	117-120
 Explanation of Terminology.....	121
 Installation In Cold Regions.....	122-123
 System Control.....	124-127
 Optional Parts.....	128-147
 Additional Information.....	148-155
 Correction Factors.....	156-159
 External Dimensions.....	160-171

# Nv-Series Model Reference Guide

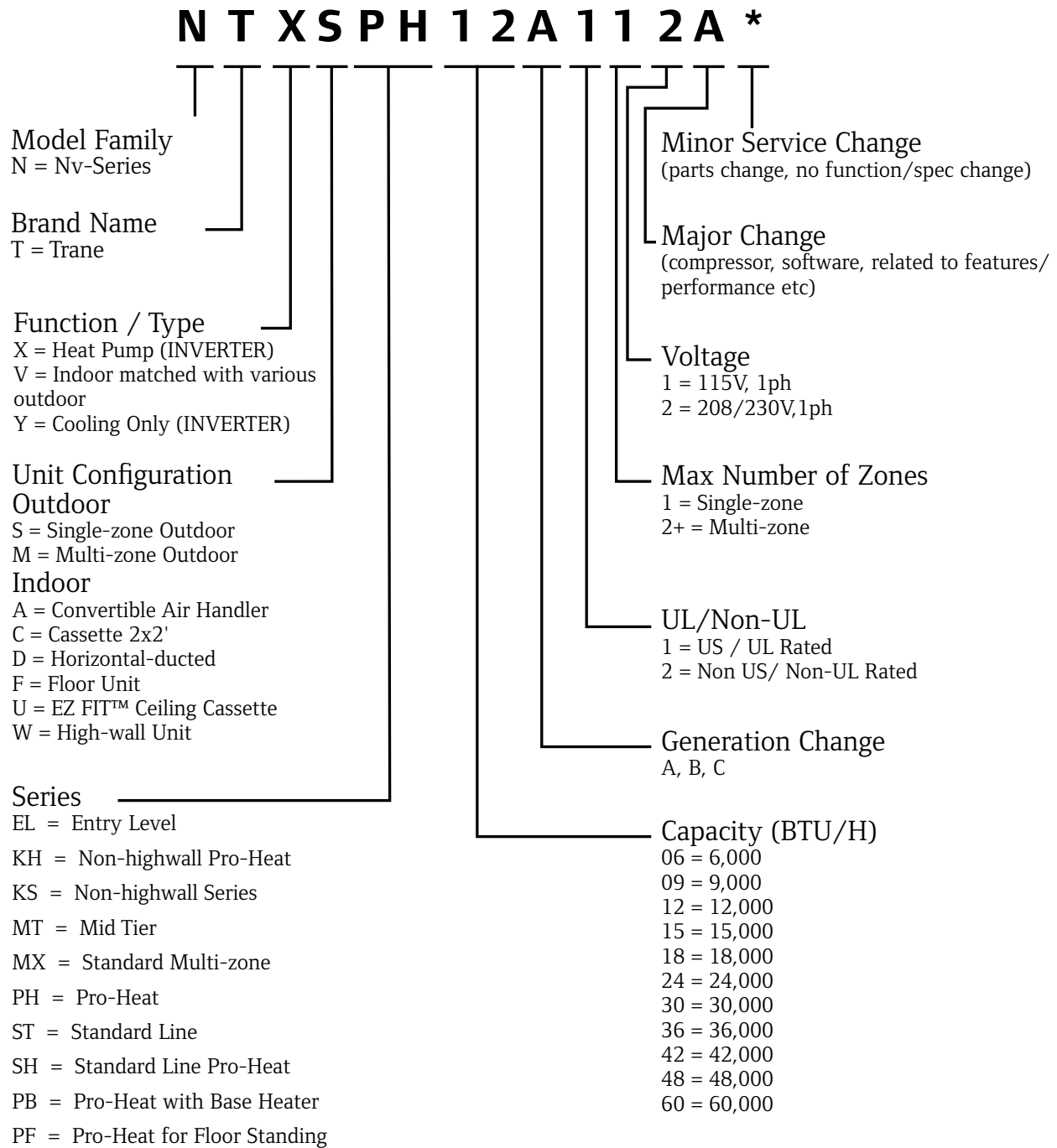

- Designed for residential applications
- User-friendly zoned cooling and heating solutions for single- or multi-room applications or the whole home
- Pro-Heat INVERTER-driven outdoor units can provide high heating performance at lower ambient temperatures
- Many ENERGY STAR® certified models





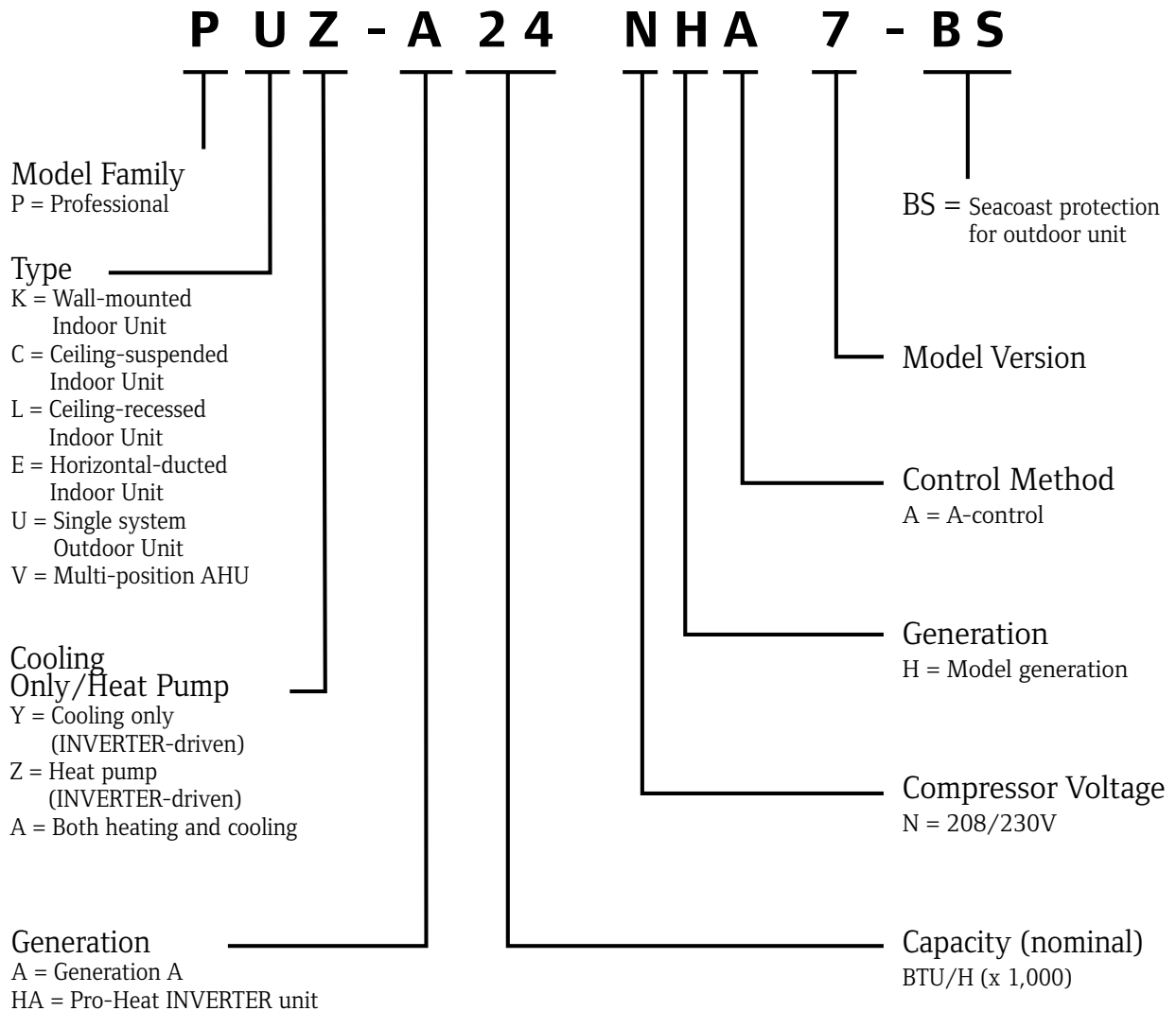









# P-Series Model Reference Guide



- Designed for light commercial installations. Ideal for applications requiring year-round, low ambient cooling such as computer, elevator and equipment rooms
- Pro-Heat outdoor units can provide superior heating performance at lower ambient temperatures
- Long lineset lengths
- Outside air intake on PLA, PCA, PEAD and PVA models
- P-Series ducted units have higher static than most Nv-Series, allowing for design flexibility

# Nv-Series

Model Name		6,000 BTU/H	9,000 BTU/H	12,000 BTU/H	15,000 BTU/H	18,000 BTU/H	24,000 BTU/H	30,000 BTU/H	36,000 BTU/H
Wall Mounted	NTXWPH Model 	●	●	●	●	●			
	MSZ-EF Model 		W·S·B ● *1	W·S·B ● *1	W·S·B ● *1	W·S·B ● *1			
	NTXWST Model 	● *1	●	●	●	●	●	●	●
	NTXWMT Model 		● *2	● *2	● *2	● *2	● *2		
	NTXWMT 115V Model 		● *2	● *2					
	NTXWEL Model 		● *2	● *2		● *2	● *2		
	NTYWST Model <small>COOLING ONLY</small> 		● *2	● *2	● *2	● *2	●	● *2	● *2
Floor Mounted	NTXFKS Model 		●	●	●	●			
EZ FIT™ Ceiling Cassette	NTXUKS Model 		●	●		●			
Multi-position Air Handler	NTXAMT Model 			●		●	●	●	●
Ceiling Cassette	NTXCKS Model 		●	●	●	● *2			
Horizontal Ducted	NTXDKS Model 		●	●	●	●			

\*1 MX connection only  
\*2 Single-zone connection only

W·S·B: Indoor units are available in three colors; White, Silver, and Black.



# MX Model

Model Name	Capacity	Wall Mounted	Floor Mounted	EZ FIT™ Ceiling Cassette	4-way Ceiling Cassette	Horizontal Ducted	Multi-position Air Handler	Ceiling Suspended	
Heat Pump	NTXMMX20A122** up to 2 indoor units	20,000 BTU/H [1-phase]	WPH 06/09/12/15 MSZ-EF 09/12/15 NTXWST 06/09/12/15	FKS 09/12/15	UKS 09/12	CKS 09/12	DKS 09/12/15 PEAD-A12	AMT 12	
	NTXMMX24A132** up to 3 indoor units	24,000 BTU/H [1-phase]	WPH 06/09/12/15/18 MSZ-EF 09/12/15/18 NTX- WST06/09/12/15/18	FKS 09/12/ 15/18	UKS 09/12/18	CKS 09/12/15 PLA-A18	DKS 09/12/15/18 PEAD-A12/18	AMT 12/18	
	NTXMMX30A132** up to 3 indoor units	30,000 BTU/H [1-phase]	WPH 06/09/12/15/18 MSZ-EF 09/12/15/18 NTXWST 06/09/12/15/18/24	FKS 09/12/ 15/18	UKS 09/12/18	CKS 09/12/15 PLA-A18	DKS 09/12/15/18 PEAD-A12/18/24	AMT 12/18/24	PCA-A24
	NTXMMX36A142** up to 4 indoor units	36,000 BTU/H [1-phase]	WPH 06/09/12/15/18 MSZ-EF 09/12/15/18 NTXWST 06/09/12/15/18/24	FKS 09/12/ 15/18	UKS 09/12/18	CKS 09/12/15 PLA-A18	DKS 09/12/15/18 PEAD-A12/18/24	AMT 12/18/ 24/30/36	PCA-A24
	NTXMMX42A152** up to 5 indoor units	42,000 BTU/H [1-phase]	WPH 06/09/12/15/18 MSZ-EF 09/12/15/18 NTXWST 06/09/12/15/18/24	FKS 09/12/ 15/18	UKS 09/12/18	CKS 09/12/15 PLA-A18	DKS 09/12/15/18 PEAD-A12/18/24	AMT 12/18/ 24/30/36	PCA-A24
	NTXMMX48A182** *3 up to 8 indoor units	48,000 BTU/H [1-phase]	WPH 06/09/12/15/18 MSZ-EF 09/12/15/18 NTXWST 06/09/12/15/18/24	FKS 09/12/ 15/18	UKS 09/12/18	CKS 09/12/15 PLA-A 12/18/24/30/36	DKS 09/12/15/18 PEAD-A 12/18/24/30/36	AMT 12/18/ 24/30/36	
	NTXMMX60A182** *3 up to 8 indoor units	60,000 BTU/H [1-phase]	WPH 06/09/12/15/18 MSZ-EF 09/12/15/18 NTXWST 06/09/12/15/18/24	FKS 09/12/ 15/18	UKS 09/12/18	CKS 09/12/15 PLA-A 12/18/24/30/36	DKS 09/12/15/18 PEAD-A 12/18/24/30/36	AMT 12/18/ 24/30/36	
Pro-Heat	NTXMPH20A122** up to 2 indoor units	20,000 BTU/H [1-phase]	WPH 06/09/12/15 MSZ-EF 09/12/15 NTXWST 06/09/12/15	FKS 09/12/15	UKS 09/12	CKS 09/12	DKS 09/12/15 PEAD-A12	AMT1 2	
	NTXMPH24A132** up to 3 indoor units	24,000 BTU/H [1-phase]	WPH 06/09/12/15/18 MSZ-EF 09/12/15/18 NTXWST 06/09/12/15/18	FKS 09/12/15/18	UKS 09/12/18	CKS 09/12/15 PLA-A18	DKS 09/12/15/18 PEAD-A12/18	AMT 12/18	
	NTXMPH30A132** up to 3 indoor units	30,000 BTU/H [1-phase]	WPH 06/09/12/15/18 MSZ-EF 09/12/15/18 NTXWST 06/09/12/15/18/24	FKS 09/12/15/18	UKS 09/12/18	CKS 09/12/15 PLA-A18	DKS 09/12/15/18 PEAD-A12/18/24	AMT 12/18/24	PCA-A24
	NTXMPH36A142** *3 up to 4 indoor units	36,000 BTU/H [1-phase]	WPH 06/09/12/15/18 MSZ-EF 09/12/15/18 NTXWST 06/09/12/15/18/24	FKS 09/12/15/1	UKS 09/12/18	CKS 09/12/15 PLA-A12/18/ 24/30/36	DKS 09/12/15/18 PEAD-A12/18/ 24/30/36	AMT 12/18/24/30/36	
	NTXMPH42A152** *3 up to 5 indoor units	42,000 BTU/H [1-phase]	WPH 06/09/12/15/18 MSZ-EF 09/12/15/18 NTXWST 06/09/12/15/18/24	FKS 09/12/15/18	UKS 09/12/18	CKS 09/12/15 PLA-A12/18/ 24/30/36	DKS 09/12/15/18 PEAD-A12/18/ 24/30/36	AMT 12/18/24/30/36	
	NTXMMX48A182** *3 up to 8 indoor units	48,000 BTU/H [1-phase]	WPH 06/09/12/15/18 MSZ-EF 09/12/15/18 NTXWST 06/09/12/15/18/24	FKS 09/12/15/18	UKS 09/12/18	CKS 09/12/15 PLA-A12/18/ 24/30/36	DKS 09/12/15/18 PEAD-A12/18/ 24/30/36	AMT 12/18/24/30/36	

\*3 The number of indoor units are limited when connected to PLA. For more information, please refer to pg.85-86  
The number of ducted models (AMT, DKS, PEAD) connectable may be limited based on the outdoor unit and combination - refer to the compatibility charts.

# P-Series

## COOLING ONLY Models (PUY)

Model Name		12,000 BTU/H	18,000 BTU/H	24,000 BTU/H	30,000 BTU/H	36,000 BTU/H	42,000 BTU/H
4-way Ceiling Cassette	PLA Model 	●	●	●	●	●	●
Wall Mount	PKA Model 	●	●	●	●	●	
Multi-position Air Handler	PVA Model 	●	●	●	●	●	●
Horizontal Ducted	PEAD Model 	●	●	●	●	●	●
Ceiling-suspended	PCA Model 			●	●	●	●

## HEAT PUMP Models (PUZ)

Model Name		12,000 BTU/H	18,000 BTU/H	24,000 BTU/H	30,000 BTU/H	36,000 BTU/H	42,000 BTU/H
4-way Ceiling Cassette	PLA Model 	●	●	●	●	●	●
Wall Mount	PKA Model 	●	●	●	●	●	
Multi-position Air Handler	PVA Model 	●	●	●	●	●	●
Horizontal Ducted	PEAD Model 	●	●	●	●	●	●
Ceiling-suspended	PCA Model 			●	●	●	●



PRO-HEAT Models (PUZ-HA)

Model Name		24,000 BTU/H	30,000 BTU/H	36,000 BTU/H	42,000 BTU/H
4-way Ceiling Cassette	PLA Model 	●	●	●	●
Wall Mount	PKA Model 	●	●	●	
Multi-position Air Handler	PVA Model 	●	●	●	●
Horizontal Ducted	PEAD Model 	●	●	●	●
Ceiling-suspended	PCA Model 	●	●	●	●

# QUALITY AND TESTING

## Quality First. Always.

Cutting-edge technologies and uncompromising commitment to quality and reliability have made us one of the world's most trusted brands in air-conditioning and refrigeration equipment and service.

### DEVELOPMENT

#### Operating Tests in Harsh Conditions

Harsh environmental conditions of cold regions are simulated for the development of our air conditioners. This is another reason customers in severely cold regions rely on us for comfortable heating.



#### Combustion Test

Products are subjected to a wide range of tests including combustion testing, all to confirm safe operation under a variety of conditions. Combustion testing is done by assuming accidental firing and replicating abnormal conditions that cause breakage of pressure components.



Explosion-proof chamber

#### Shock Resistance

On the assumption of many different kinds of logistics environments in the world, we perform drop/strength tests, transport vibration tests, and many other product checks to assure that the quality and performance are maintained when the product reaches the user's home.



Drop/strength testing



Transport vibration testing

## Waterproof and Corrosion Test

Since the outdoor unit is subject to rain, wind, and corrosive substances, potential problems are checked by tests such as showering the unit for a certain amount of time and increasing protection to enhance the lifespan of the unit.



## Operation Noise Test

Operation noise tests are performed in an anechoic chamber with an extremely low 10dB(A) of background noise. This is just one of the ways we ensure our customers enjoy extremely quiet air conditioners with a minimum operation noise of 19dB(A) (sound pressure level).



Anechoic chamber

## DESIGN

### Designed to create and maintain a comfortable environment

To improve the quality of products, engineers strive to achieve our philosophy of combining comfort and ecology in an effort to continually raise the bar. Therefore, we are working to further improve quality at all stages from development to production.



## PRODUCTION

### Each and every unit is checked and double-checked by experienced professionals

Every air conditioner goes through a rigorous electrical inspection on the manufacturing line. In final testing, our experienced inspectors listen for even the faintest operation noise to detect any defect.



# INVERTER TECHNOLOGIES

**Our Promise: Mitsubishi Electric inverters ensure superior performance including the optimum control of operation frequency. As a result, optimum power is applied in all heating/cooling ranges and maximum comfort is achieved while consuming minimal energy. Fast, comfortable operation and amazingly low running cost — that's the Mitsubishi Electric promise.**

## INVERTERS – HOW THEY WORK

Inverters electronically control the electrical voltage, current and frequency of electrical devices such as the compressor motor in an air conditioner. They receive information from sensors monitoring operating conditions, and adjust the revolution speed of the compressor, which directly regulates air conditioner output. Optimum control of operation frequency results in eliminating the consumption of excessive electricity and providing the most comfortable room environment.

## ECONOMIC OPERATION

Impressively low operating cost is a key advantage of inverter air conditioners. We've combined advanced inverter technologies with cutting-edge electronics and mechanical technologies to achieve a synergistic effect that enables improvements in heating/cooling performance efficiency. Better performance and lower energy consumption are the result.

## TRUE COMFORT

Below is a comparison of air conditioner operation control with and without an inverter.

### ■ Inverter operation comparison

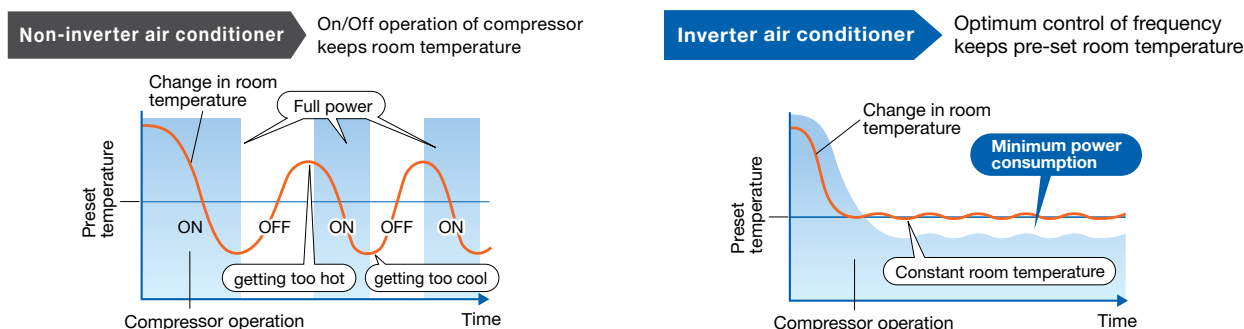

The compressors of air conditioners without an inverter start and stop repeatedly in order to maintain the pre-set room temperature. This repetitive on/off operation uses excessive electricity and compromises room comfort. The compressors of air conditioners equipped with an inverter run continuously; the inverter quickly optimizing the operating frequency according to changes in room temperature. This ensures energy-efficient operation and a more comfortable room.

### POINT 1 Quick & Powerful

Increasing the compressor motor speed by controlling the operation frequency ensures powerful output at start-up, brings the room temperature to the comfort zone faster than units not equipped with an inverter. Hot rooms are cooled, and cold rooms are heated faster and more efficiently.

### POINT 2 Room Temperature Maintained

The compressor motor operating frequency and the change of room temperature are monitored to calculate the most efficient waveform to maintain the room temperature in the comfort zone. This eliminates the large temperature swings common with non-inverter systems, and guarantees a pleasant, comfortable environment.

## KEY TECHNOLOGIES

### Our Rotary Compressor

Our rotary compressors use our original Poki-Poki Motor and Heat Caulking Fixing Method to realize downsizing and higher efficiency, and are designed to match various usage scenes in residential and commercial applications. Additionally, development of an innovative production method known as "Divisible Middle Plate" realizes further size/weight reductions and increased capacity while also answering energy-efficiency needs.

### Our Scroll Compressor

Our scroll compressors are equipped with an advanced frame compliance mechanism that allows self-adjustment of the position of the orbiting scroll according to pressure load and the accuracy of the fixed scroll position. This minimizes gas leakage in the scroll compression chamber, maintains cooling capacity and reduces power loss.



## MORE ADVANTAGES WITH OUR PRODUCTS



### Joint Lap DC Motor

Mitsubishi Electric has developed a unique motor, called the Poki-Poki Motor in Japan, which is manufactured using a joint lapping technique. This innovative motor operates based on a high-density, high-magnetic force, leading to extremely high efficiency and reliability.



### Magnetic Flux Vector Sine Wave Drive

This drive device is actually a microprocessor that converts the compressor motor's electrical current waveform from a conventional waveform to a sine wave (180° conduction) to achieve higher efficiency by raising the motor winding utilization ratio and reducing energy loss.



### Reluctance DC Rotary Compressor

Powerful neodymium magnets are used in the rotor of the reluctance DC motor. More efficient operation is realized by strong magnetic and reluctance torques produced by the magnets.

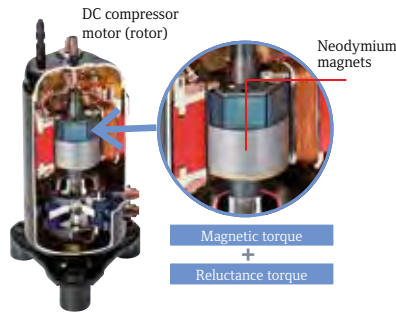

### Highly Efficient DC Scroll Compressor

Higher efficiency has been achieved by adding a frame compliance mechanism to the DC scroll compressor. The mechanism allows movement in the axial direction of the frame supporting the cradle scroll, thereby greatly reducing leakage and friction loss, and ensuring extremely high efficiency at all speeds.

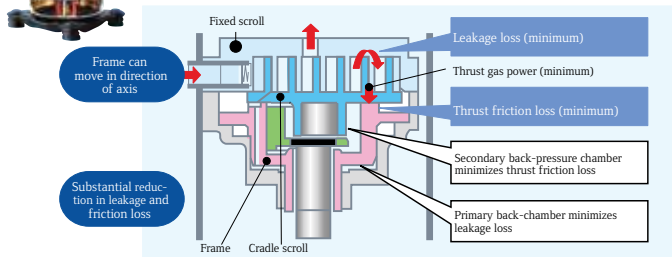

### Heat Caulking Fixing Method

To fix internal parts in place, a Heat Caulking Fixing Method is used, replacing the former arc spot welding method. Distortion of internal parts is reduced, realizing higher efficiency.



### DC Fan Motor

A highly efficient DC motor drives the fan of the outdoor unit. Efficiency is much higher than an equivalent AC motor.



### Vector-Wave Eco Inverter

This inverter monitors the varying compressor motor frequency and creates the most efficient waveform for the motor speed. As a result, operating efficiency in all speed ranges is improved, less power is used and annual electricity cost is reduced.

#### Smooth wave pattern

Inverter size has been reduced using insert-molding, where the circuit pattern is molded into the synthetic resin. To ensure quiet operation, soft PWM control is used to prevent the metallic whine associated with conventional inverters.

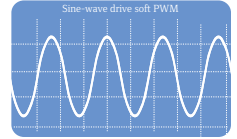

### PAM (Pulse Amplitude Modulation)

PAM is a technology that controls the current waveform so that it resembles the supply voltage wave, thereby reducing loss and realizing more efficient use of electricity. Using PAM control, 98% of the input power supply is used effectively.

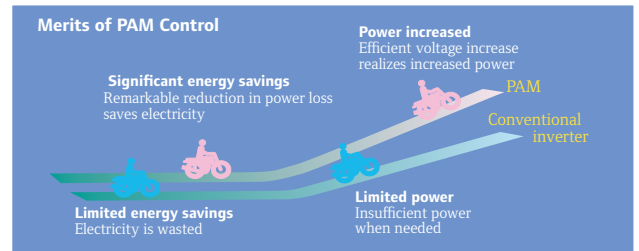
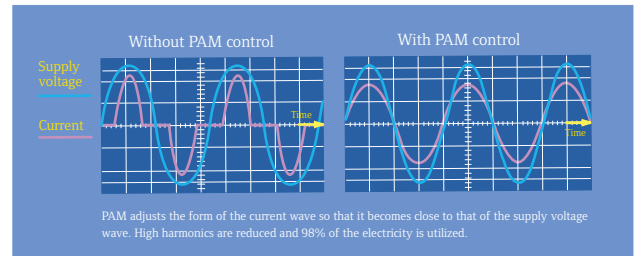

### Power Receiver and Twin LEV Control

Mitsubishi Electric has developed a power receiver and twin linear expansion valves (LEVs) circuit that optimize compressor performance. This technology ensures optimum control in response to operating waveform and outdoor temperature. Operating efficiency has been enhanced by tailoring the system to the characteristics of R410A refrigerant.

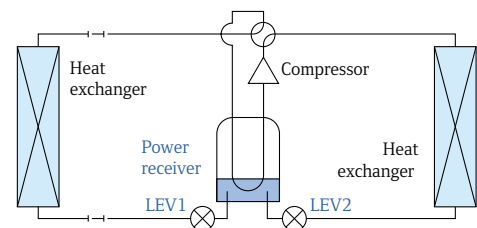

### Grooved Piping

High-performance grooved piping is used in heat exchangers to increase the heat exchange area.

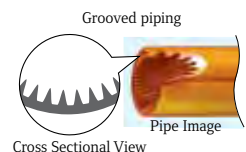

# FEATURES

## 3D i-see Sensor®

### 3D i-see Sensor for Nv-Series

The WPH Model is equipped with 3D i-see Sensor®, an infrared-ray Sensor that measures the temperature at distant positions. While moving to the left and right, eight vertically arranged Sensor elements analyze the room temperature in three dimensions. This detailed analysis makes it possible to judge where people are in the room, thus allowing creation of features such as Indirect Airflow, to avoid airflow hitting people directly, and Direct Airflow to deliver airflow to where people are located in the space.

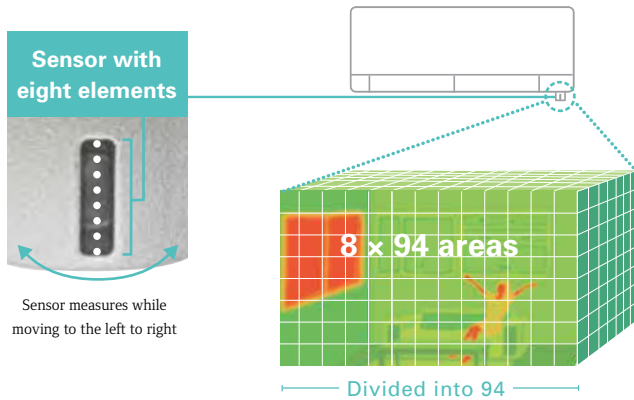

#### Indirect Airflow

The Indirect Airflow setting can be used when the flow of air feels too strong or direct. For example, it can be used during cooling to avert airflow and prevent body temperature from becoming excessively cooled.

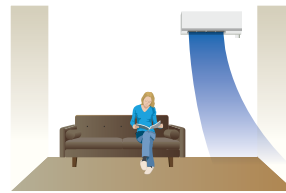

#### Direct Airflow

This setting can be used to directly target airflow at people such as for immediate comfort when coming indoors on a hot (cold) day.

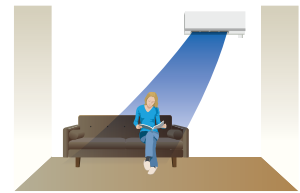

#### Absence Detection

The Sensors detect whether there are people in the room. When no-one is in the room the unit automatically switches to energy-saving mode.

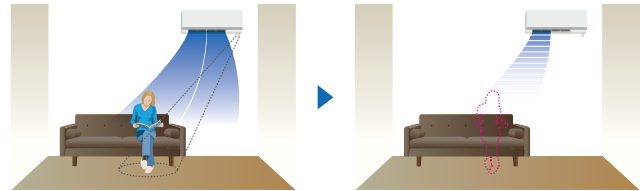

The 3D i-see Sensor detects people's absence and the power consumption is automatically reduced approximately 10% after 10 minutes and 20% after 60 minutes.

### 3D i-see Sensor for CKS and PLA Models

#### Detects number of people

The 3D i-see Sensor detects the number of people in the room and adjusts the power accordingly. This makes automatic power-saving operation possible in places where the number of people changes frequently. Additionally, when the area is continuously unoccupied, the system switches to a more enhanced power-saving mode. Depending on the setting, it can also stop the operation.

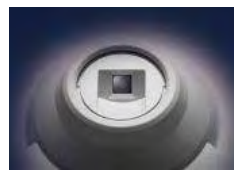

Detects number of people

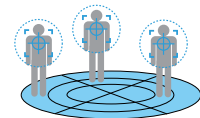

Detects people's position

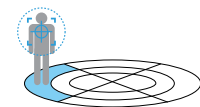

#### Detects people's position

Once a person is detected, the angle of the vane is automatically adjusted. Each vane can be independently set to Direct Airflow or Indirect Airflow according to preference.

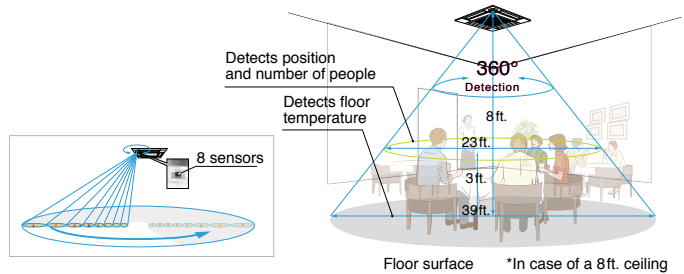

#### Highly accurate people detection

A total of eight Sensors rotate a full 360° in 3-minute intervals. In addition to detecting human body temperature, our original algorithm also detects people's positions and the number of people in the space.

## Detects number of people

### Room occupancy energy-saving mode

The 3D i-see Sensor detects the number of people in the room. It then calculates the occupancy rate based on the maximum number of people in the room up to that point in time in order to save air-conditioning power. When the occupancy rate is approximately 30%, air-conditioning power equivalent to 2° F during both cooling and heating operation is saved. The temperature is controlled according to the number of people.

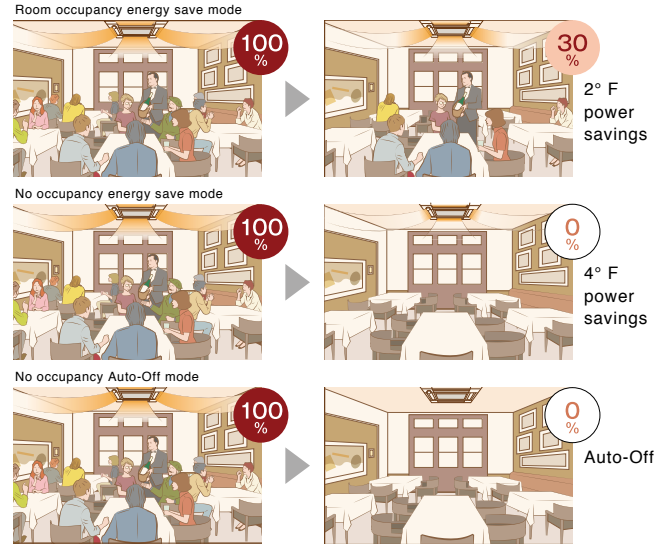

### No occupancy energy-saving mode

When 3D i-see Sensor detects that no one is in the room, the system is switched to a pre-set power-saving mode. If the room remains unoccupied for more than 60 min, air-conditioning power equivalent to 4° F during both cooling and heating operation is saved. This contributes to preventing waste in terms of heating and cooling.

### No occupancy Auto-OFF mode

When the room remains unoccupied for a pre-set period of time, the air conditioner turns off automatically, thereby providing even greater power savings. The time until operation is stopped can be set in intervals of 10 min, ranging from 60 to 180 min.

## Detects people's position

### Direct/Indirect settings\*

The horizontal airflow spreads across the ceiling. When set to Indirect Airflow that uncomfortable drafty-feeling is eliminated completely!

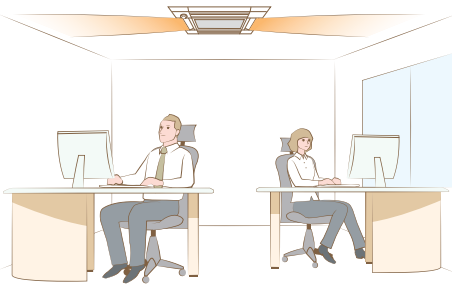

\*TAR-40MAAU is required for each setting.

### Seasonal airflow\*

#### When Cooling

Saves energy while keeping a comfortable effective temperature by automatically switching between ventilation and cooling. When a pre-set temperature is reached, the air conditioning unit switches to swing fan operation to maintain the effective temperature. This clever function contributes to keeping a comfortable coolness.

The air conditioning unit automatically switches between circulator and heating. Wasted heat that accumulates near the ceiling is re-used via circulation. When a pre-set temperature is reached the air conditioner switches from heating to circulator and blows air in the horizontal direction. It pushes down the warm air that has gathered near the ceiling to people's height, thereby providing smart heating.

#### When Heating

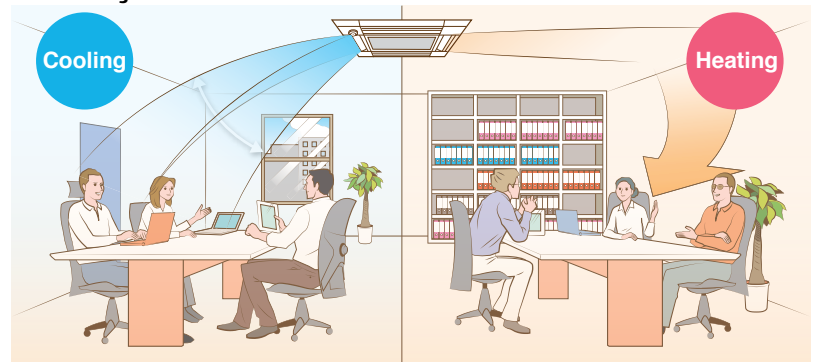

\*TAR-40MAAU is required for each setting.

### AREA Area Temperature Monitor

The 3D i-see Sensor monitors the whole room in sections and directs the airflow to areas of the room where the temperature does not match the temperature setting. (When cooling the room, if the middle of the room is detected to be hotter, more airflow is directed towards it.) This eliminates unnecessary heating / cooling and contributes to lower electricity costs.

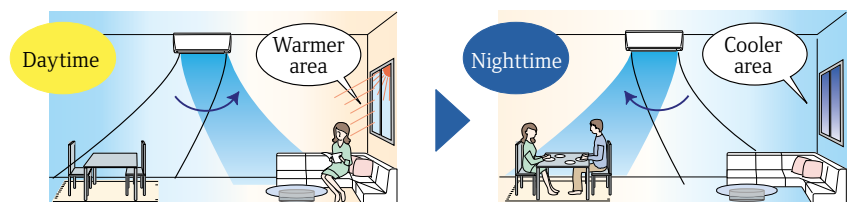

Cooling mode

## ENERGY-SAVING



### Econo Cool Energy-Saving Feature

Econo Cool is an intelligent temperature control feature that adjusts the amount of air directed towards the body based on the air-outlet temperature. The setting temperature can be raised by as much as 4° F without any loss in comfort, thereby realizing a 20% gain in energy efficiency. (Function only available during manual cooling operation.)

	Conventional	Econo Cool
Ambient Temperature	95° F	95° F
Set Temperature	77° F	81° F
Perceived Temperature	86° F	85° F

#### Econo Cool Mode

A comfortable room environment is maintained even when setting the temperature 4° F higher than the conventional cooling mode.

Econo Cool on



Conventional cooling mode



Temperature distribution (° F)

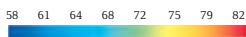

### Demand Function (Onsite Adjustment)

The demand function can be activated when the unit is equipped with a commercially available timer or an On/Off switch is added to the CNDM connector (option) on the control board of the outdoor unit. Energy consumption can be reduced up to 100% of the normal consumption according to the signal input from outside.

[Example: P-Series]

Limit energy consumption by changing the settings of SW7-1, SW1 and SW2 on the control board of the outdoor unit. The following settings are possible.

SW7-1	SW1	SW2	Energy Consumption
ON	OFF	OFF	100%
	ON	OFF	75%
	ON	ON	50%
	OFF	ON	0% (Stop)

\* PUY/PUZ outdoor only



### Blue Fin Heat Exchanger

Anti-corrosion treatment is done to the heat exchanger of the outdoor units. This coating prevents the corrosion of the aluminum fins caused by salt in the air especially in coastal areas. (Corrosion of the heat exchanger will effect the efficiency and performance of the air conditioner.)

## AIR QUALITY



### Nano Platinum Filter

This filter has a large capture area and incorporates nanometer-sized platinum-ceramic particles that work to kill bacteria and deodorize the circulating air.



### Catechin Filter

Catechin is a bioflavonoid by-product of green tea with both antiviral and antioxidant qualities. In addition to improving air quality, it prevents the spreading of bacteria and viruses throughout the room, and also has an excellent deodorizing effect.



### Air Filter

This filter can remove dust particles from the air.



### Deodorizing Filter

The catalyst coating on the honeycomb-structured frame captures small foul-smelling substances in the air, then breaks down the source of the odors with the power of the ozone generated in a plasma electrode unit.



### Electrostatic Anti-Allergy Enzyme Filter

This filter is charged with static electricity, enabling it to attract and capture dust particles that regular filters cannot capture. This filter can also trap allergens such as bacteria and decompose them using enzymes retained in the filter.



### Air Purifying Filter

The filter has a large capture area and deodorize the circulating air.



### Fresh-air Intake

Indoor air quality is enhanced by the direct intake of fresh exterior air.



### High-efficiency Filter

This high-performance filter has a much finer mesh compared to standard filters, and is capable of capturing minute particulates floating in the air that were not previously caught.



### Oil Mist Filter

The oil mist filter prevents oil mist from penetrating into the inner part of the air conditioner.



### Long-life Filter

A special process for the entrapment surface improves the filtering effect, making the maintenance cycle longer than that of units equipped with conventional filters.



### Filter Check Signal

Air conditioner operating time is monitored, and the user is notified when filter maintenance is necessary.



## AIR DISTRIBUTION



### Double Vane

Double vane separates the airflow in the different directions to deliver airflow not only across a wide area of the room, but also simultaneously to two people in different locations.



### Natural Flow Operation

Airflow will become more like natural wind. An occupant will not be directly exposed to the airflow and feel more comfortable.



### Indirect/Direct Mode

This mode offers finely-tuned operation by locating where an occupant is in the room and sends the air directly or indirectly according to the selected mode.



### Powerful Operation

The air conditioner will automatically adjust the fan speed and set temperature for 15 minutes. Rapid cooling and heating will make the room comfortable more quickly.



### Wide Airflow

Especially beneficial for large spaces, helping to ensure that the air is well circulated and reaches every corner of the room. Select the desired airflow pattern and it will distribute air horizontally over a wide-ranging 150° in heating mode and 100° in cooling mode.



### Horizontal Vane

The air outlet vane swings up and down so that the airflow is spread evenly throughout the room.



### Vertical Vane

The air outlet fin swings from side to side so that the airflow reaches every part of the room.



### High Ceiling Mode

In the case of rooms with high ceilings, the outlet-air volume can be increased to ensure that air is circulated all the way to the floor.



### Low Ceiling Mode

If the room has a low ceiling, the airflow volume can be reduced for less draft.



### Auto Fan Speed Mode

The airflow speed mode adjusts the fan speed of the indoor unit automatically according to the present room conditions.



### Auto Vane Control

Outlet vanes can be moved left and right, and up and down using the remote controller. This improved airflow control feature solves the problem of drafts.

## BLUE FIN COATING



### Blue Fin Condenser

Anti-corrosion treatment is done to the heat exchanger of the outdoor units. This coating prevents the corrosion of the aluminum fins caused by salt in the air especially in coastal areas. (Corrosion of the heat exchanger will effect the efficiency and performance of the air conditioner.)

#### Standard HEX coatings:

Rated for **240 hours** spraying time\*

#### Blue Fin HEX coatings:

Rated for **960 hours** spraying time\*

\*Per JRA 9002 Standard

Coating is applied on all Nv-Series single-zone outdoor units

Compatibility:	
Outdoor Unit	Blue Fin Coating
SPH	•
SPF	•
SST	•
SMT	•
SMT 115V	•
SEL	•
SKS (9, 12,15)	•
SKH	•
PUZ/Y-BS (sea coast protection models only)	•
MMX/MPH Multi-zone (branch box type)	•

## CONVENIENCE

### Smart Set

Smart Set is a simplified setting function that recalls the preferred (pre-set) temperature by pressing a single button on the remote controller. Press the same button twice in repetition to immediately return to the previous temperature setting. Using this function contributes to comfortable waste-free operation, realizing the most suitable air conditioning settings and saving on power consumption when, for example, leaving the room or going to bed.

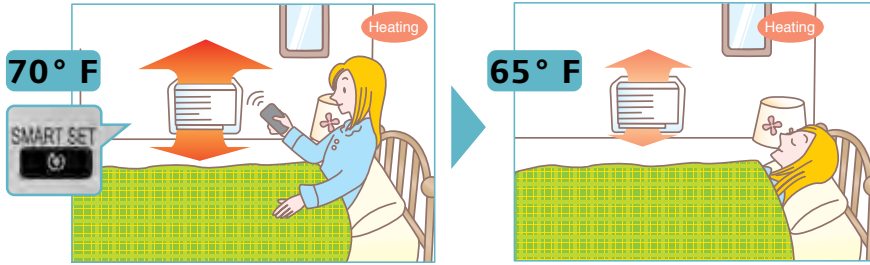

### Auto Changeover

The air conditioner automatically switches between heating and cooling modes to maintain the desired temperature.

### Operation Lock (Outdoor unit)

To accommodate specific-use applications, cooling or heating operation can be specified when setting the control board of the outdoor unit. A convenient option when a system needs to be configured for exclusive cooling or heating service.

### Low-temperature Cooling

Intelligent fan speed control in the outdoor unit ensures optimum performance even when the outside temperature is low.

### Sleep Mode

When Sleep Mode is activated using the wireless remote controller, it will switch to the settings described below.

- After 30 minutes, the set temperature will automatically change to the sleep mode set temperature which the user can set beforehand.
- The fan speed will immediately change to low fan speed.

### Ampere Limit Adjustment

Dip switch settings can be used to adjust the maximum electrical current for operation. This function is highly recommended for managing energy costs.

\*Maximum capacity is lowered with the use of this function.

### On/Off Operation Timer

Use the remote controller to set the times of turning the air conditioner On/Off.

### Auto Restart

Especially useful at the time of power outages, the unit turns back on automatically when power is restored.

Easily set desired temperatures and operation ON/OFF times to match lifestyle patterns. Reduce wasted energy consumption by using the timer to prevent forgetting to turn off the unit and eliminate temperature setting adjustments.

■ Sample Operation Pattern (Winter/Heating mode)

	Mon.	Tues.	Wed.	Thurs.	Fri.	Sat.	Sun.
6:00 AM	ON 68°F	ON 68°F	ON 68°F	ON 68°F	ON 68°F	ON 68°F	ON 68°F
	Automatically changes to high-power operation at wake-up time						
8:00 AM							
10:00 AM	OFF	OFF	OFF	OFF	OFF	ON 64°F	ON 64°F
12:00 AM	Automatically turned off during work hours					Midday is warmer, so the temperature is set lower	
2:00 PM							
4:00 PM							
6:00 PM	ON 72°F	ON 72°F	ON 72°F	ON 72°F	ON 72°F	ON 72°F	ON 72°F
8:00 PM	Automatically turns on, synchronized with arrival at home					Automatically raises temperature setting to match time when outside-air temperature is low	
10:00 PM							
(during sleeping hours)	ON 64°F	ON 64°F	ON 64°F	ON 64°F	ON 64°F	ON 64°F	ON 64°F
	Automatically lowers temperature at bedtime for energy-saving operation at night						

**Settings** **Pattern Settings:** Input up to four settings for each day  
**Settings:** • Start/Stop operation • Temperature setting \*The operation mode cannot be set.

■ Easy set-up using dedicated buttons

The remote controller is equipped with buttons that are used exclusively for setting the Weekly Timer. Setting operation patterns is easy and quick.

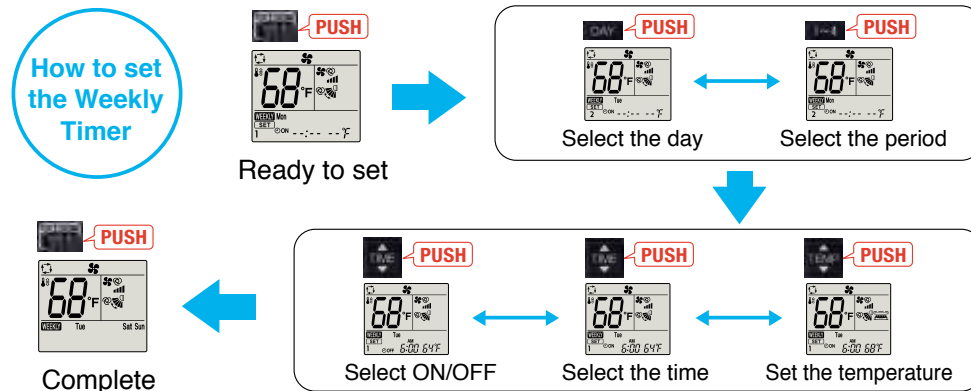

- Start by pushing the "SET" button and follow the instructions to set the desired patterns. Once all of the desired patterns are input, point the top end of the remote controller at the indoor unit and push the "SET" button one more time. (Push the "SET" button only after inputting all of the desired patterns into the remote controller memory. Pushing the "CANCEL" button will end the set-up process without sending the operation patterns to the indoor unit).
- It takes a few seconds to transmit the Weekly Timer operation patterns to the indoor unit. Please continue to point the remote controller at the indoor unit until all data has been sent.

## SYSTEM CONTROL

### System Group Control

The same remote controller is capable of controlling the operational status of up to 16 refrigerant systems.

### kumo cloud® Wireless Interface

Along with your smart phone or tablet device, you can manage your system in multiple venues, such as home, work and vacation locations. You can control functions like turning on/off, fan speed, and vane direction.

### M-NET Connection

Units can be connected to MELANS system controllers (M-NET controllers) such as the AE-200A.

### MXZ Connection

Connection to the MX multi-split outdoor unit is possible.



Wireless Interface 2



Apple and the App Store are registered trademarks of Apple, Inc.  
Amazon, Alexa, Fire and all related logos are trademarks of Amazon.com, Inc. or its affiliates. Google play is a registered trademark of Google, Inc.



## Manage Your Comfort From Anywhere With kumo cloud

- Now compatible with Nv-Series and P-Series systems
- kumo cloud allows for a Trane®/Mitsubishi Electric indoor unit to be controlled remotely or locally with the app
- For product information go to [kumocloud.com](http://kumocloud.com)
- Ability to group units and organize groups into sites
- Batch command units
- Ability to program events and scheduling into the unit itself
- Available in Fahrenheit or Celsius
- Easy to connect the device to your router using the kumo cloud app
- Each indoor unit must be equipped with a Wireless Interface (PAC-USWHS002-WF-2) installed by a licensed contractor
- Secure boot to prevent unauthorized reprogramming of Wireless Interface
- Intuitive initial settings feature for Nv- & P-Series equipment

Did you forget to turn off your unit before leaving for vacation? You don't have a worry in the world when you have the kumo cloud app. You can change temperatures, set and store a schedule, and much more from anywhere. It really is comfort made personal.

Anytime, Anywhere Control kumo cloud gives you the ability to effortlessly control your home's comfort. Whether you're out for the day or the month, looking to cool down or warm up, kumo cloud gives you control from any smart phone, tablet or web browser.

**Program and Schedules:** kumo cloud walks you through a five-step process to easily schedule the mode, set temperature and fan speed, for an individual zone or several zones at once.

**Easily Zoned:** Once your Wireless Interface is installed on your indoor unit by a trained HVAC professional, the indoor unit will discover the app. Name your indoor units, create groups, and organize multiple properties from one user-friendly app.

**Check Filter Status:** You never have to manually check a filter again. kumo cloud can tell you the status of any filter in your system at any time.



Simple wall-mounted design controllers can be installed anywhere with large, backlit, easy to read display. Both the controller and receiver is enabled with RedLINK reliability.

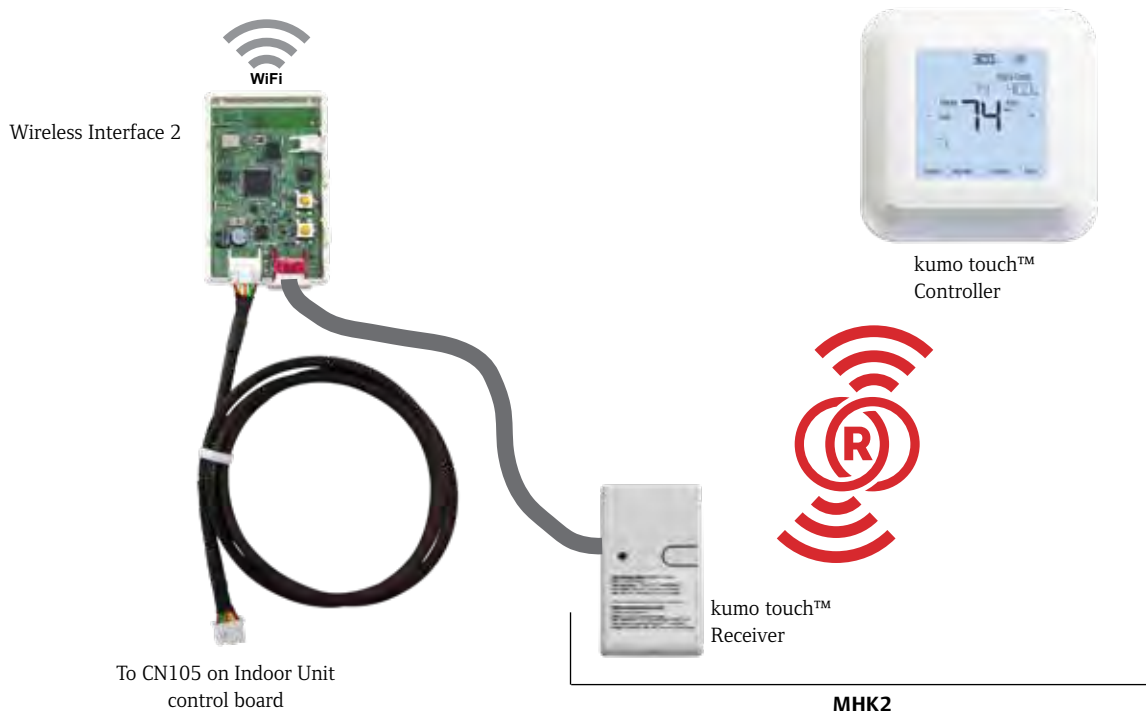

### MRCH2 kumo touch Controller Specifications

- Touch panel, Backlit, easy-to-read display
- Used RedLINK™ 3.0 wireless technology
  - Not compatible with MHK1, MOS1, and MCCH1 RedLINK 2.0 wireless technology environment
- User functions allow user to set:
  - On/Off
  - Operation modes cool, heat, drying, fan
  - Set temperature (separate dual set points for heat and cool)
  - Fan speed setting
  - Airflow direction
- Set temperature range limits (dependent on the system connected):
  - Cooling from 50° to 99° F
  - Heating from 40° to 90° F
  - Auto from 50° to 90° F with dual temperature setting
- MHK2 Scheduling options:
  - No Schedule
  - MO-SU = Every day the same
  - MO-FR, SA, SU = 5-1-1 schedule
  - MO-FR, SA-SU = 5-2 schedule
  - Each Day = Every day individual
  - Allow kumo cloud to be schedule holder
- Hold function
- Temporary or Permanent schedule override
- Lockout:
  - On, Off, Mode, Fan Speed, Set point, Vane Direction
- Day/Time display with a 12 or 24-hour clock
- Supports both Fahrenheit and Celsius
- RedLINK™ Wireless Connection Status
- Filter sign display
- Diagnostics: Displays and records error codes
- Adjustable auto mode deadband
- Space temperature offset adjustment
- Space humidity offset adjustment
- Hide (on screen only)
  - Indoor temperature
  - Indoor humidity
- Temperature Sensing Source

- MHK2
- Indoor Unit
- RedLINK Wireless Indoor Air Sensor (IAS)
- Average of MHK2 and RedLINK Wireless Indoor Air Sensor (IAS)
- Indoor Humidity Source
  - MHK2
  - RedLINK Wireless Indoor Air Sensor (IAS)
  - Average of MHK2 and RedLINK Wireless Indoor Air Sensor (IAS)
- Improved indoor unit function code list
  - Indoor unit type
  - Expanded to 28 indoor unit codes
- Reset to factory default
- Uses two “AA” alkaline batteries (included)
- Dimensions: 4-5/64” x 4-5/64” x 1-1/16” (104 x 104 x 27 mm)
- Operating Ambient Temperature: 32° to 120° F (0° to 48.9° C)
- Operating Relative Humidity: 5% to 90%

### MIFH2 WIRELESS RECEIVER SPECIFICATIONS:

- Included in MHK2 Kit
- Mounts next to or near indoor units to allow MRCH2 Remote Controller operation
- Connects to indoor unit control board with MRC2 Cable
- Dimensions: 3-3/32” H x 1-3/4” W x 39/64” D (74.8 x 44.4 x 15.4 mm)
- Operating Ambient Temperature: -40° to 165° F (-40° to 73.9° C)
- Operating Relative Humidity: 5% to 95%

### MRC2 CABLE

- Included in MHK2 Kit in the MIFH2 box
- Connects MIFH2 Wireless Receiver to the CN105 connector on indoor unit control board
- Length: 39-23/64” (1 m)

## WIRED CONTROLLERS

### Simple MA Remote Controller

- Controls group operation for up to 16 indoor units in a single group
- Supports Fahrenheit and Celsius
- User defined functions:
  - On/Off
  - Operation modes: Heat/Cool/Auto/Dry
  - Fan speed setting
  - Airflow direction
  - Set temperature range: 40° F to 95° F depending on operation mode and indoor unit connected
- Set temperature range limit for cool and heat modes
- LOSSNAY®: Simple MA for interlocked system can set high/low/stop on LOSSNAY
- Room temperature can be sensed either at indoor unit (default) or at the remote controller
- Dimensions: 2-3/4" W x 9/16" D x 4-3/4" H
- Requires MAC-334IF-E for use with Nv-Series products



TAC-YT53CRAU-J

### Deluxe MA Remote Controller

- User defined functions:
  - On/Off
  - Operation modes: Heat/Cool/Auto/Dry
  - Room temperature setting & Temperature range restriction
  - Manual vane angle (P-Series cassette indoor units)
  - Smooth maintenance (P-Series only)
  - Auto-off timer & Weekly timer
- Setting screen for 3D i-see Sensor®
- Draft reduction mode
- Daylight Saving Time (DST)
- Dimensions: 4-3/4" W x 3/4" D x 4-3/4" H
- Requires MAC-334IF-E for use with Nv-Series ductless products
- Room temperature displays room temperature sensed either at the indoor unit (default) or at the controller



TAR-40MAAU

### Touch MA Remote Controller

- User-friendly, customizable full color touch panel display
- Ability to add a custom logo on the display
- Large icons with 180 color patterns
- Daily and weekly timers
- Password protected
- Requires MAC-334IF-E for use with Nv-Series products
- The MELRemo app and Bluetooth® Low Energy (BLE) technology supports communication with smartphones or tablets in multiple languages



TAR-CT01MAU-SB

## INTERFACE DEVICES

### T-STAT Thermostat Interface

- Control your Zoned Comfort Solution using a third-party 24VAC transformer
- Wires back to the indoor unit using CN105 to replace the return air temperature sensor
- Maximum wiring length: 39 (12 m)
- Dimensions: 3.17 in (w) x 3.96 in (h) x 0.93 in (d) (80.6 x 100.6 x 23.7 mm)
- Exterior shell made of ABS resin
- Environment Conditions — operating temperature range: Installation manual states that the temperature should be between 32° F and 104° F (0° C to 40° C)



PAC-US444CN-1

### BACnet® Interface

- Allows for third-party home automation/building management system to control indoor unit
- One interface required per indoor unit
- Compatible with remote controllers
- Dimensions: 3.74" x 2" x 0.75"
- Cable length: 37"
- Allows for third-party home automation/building management system to control indoor unit



PAC-UKPRC001-CN-1

### USNAP Interface

- Allows indoor units to participate in demand response events
- Works with CTA 2045 DC Form Factor Universal Communication Modules (UCMs)
- 3 LEDs to display device status
  - Communication with UCM
  - Communication to indoor unit
  - Demand Response Events
- System Reset



PAC-WHS01UP-E

### MAC-334IF-E System Control Interface

- Allows Nv-Series indoor units to communicate with the CITY MULTI® Controls Network via M-NET
- Provides an input to allow remote On/Off control of indoor unit
- Allows Nv-Series indoor units to connect to MHK2 Wall-Mounted Wireless Controller when using other MAC-334IF-E functions
- Allows Nv-Series indoor units to connect to a MA controller
- Power: 12V DC (supplied from indoor unit)



MAC-334IF-E

# FEATURES

Category	Icon	Nv-Series																			
		Combination	Indoor unit	NTXWPH(06/09/12/15/18)A112A*						MSZ-EF09/12/15/18NA(W)(B)(S)						NTXWST(06/09/12/15/18)A112A*					
				Outdoor Unit	NTXSPH	MX 2 zone	MX 3 zone	MX 4 zone	MX 5 zone	MX 8 zone	MX 2 zone	MX 3 zone	MX 4 zone	MX 5 zone	MX 8 zone	NTXSST	MX 2 zone	MX 3 zone	MX 4 zone	MX 5 zone	MX 8 zone
i-see Sensor	Radiant Temperature Control (3D i-see Sensor®)		•	•	•	•	•	•													
	AREA Temperature Monitor		•	•	•	•	•	•													
Energy Saving	Econo Cool		•	•	•	•	•	•	•	•	•	•	•	•	•	•	•	•	•	•	
Air Quality	Nano Platinum Filter		•	•	•	•	•	•	•	•	•	•	•	•	•	•	•	•	•	•	
	Catechin Filter																				
	Air Cleaning Filter																				
	Deodorizing Filter		•	•	•	•	•	•													
	Electrostatic Anti-Allergy Enzyme Filter		•	•	•	•	•	•	•	•	•	•	•	•	24	24	24	24	24	24	
	Anti-Allergy Enzyme Filter														06-18	06-18	06-18	06-18	06-18	06-18	
	Air Purifying Filter																				
Air Distribution	Double Vane		•	•	•	•	•	•													
	Horizontal Vane		•	•	•	•	•	•	•	•	•	•	•	•	•	•	•	•	•	•	
	Vertical Vane		•	•	•	•	•	•						18/24	18/24	18/24	18/24	18/24	18/24		
	Natural Flow Operation		•	•	•	•	•	•													
	Wide Airflow													24	24	24	24	24	24		
	Indirect/Direct Airflow		•	•	•	•	•	•													
	Powerful Operation		•	•	•	•	•	•						24	24	24	24	24	24		
Convenience	Smart Set		•	•	•	•	•	•	•	•	•	•	•	06-18	06-18	06-15	06-18	06-18	06-18		
	Auto Restart		•	•	•	•	•	•	•	•	•	•	•	•	•	•	•	•	•		
	Low Temperature Cooling		•	•	•	•	•	•	•	•	•	•	•	•	•	•	•	•	•		
	Sleep Mode																				
	12H On/Off Operation Timer																				
	24H On/Off Operation Timer		•	•	•	•	•	•	•	•	•	•	•	•	•	•	•	•	•		
	Weekly Timer		•	•	•	•	•	•	•	•	•	•	•								
Maintenance	Blue Fin		•			• *1	• *1	•					• *1	• *1	•			• *1	• *1	•	

\*1 Branch box units only: NTXMMX48A182\*\*, NTXMMX60A182\*\*, NTXMPH36A142\*\*, NTXMPH42A152\*\*, and NTXMMX48A182\*\*

\*2 Sea coast protection models only (-B5)



Ny-Series																										
	NTXWST (30/36) A112A*	NTXWMT (09/12/15/ 18/24)A112A*	NTYWST (09/12/15/ 18/24)A112A*	NTYWST (30/36) A112A*	NTXWEL (09/12/18/24) A112A*	NTXWMT 115V(09/12) A111A*	NTXFKS (09/12/15/18) A112A*					NTXUKS (09/15/18) A112A*					NTXAMT (12/18/24/30/36) A112A*									
	NTXSST	NTXSMT	NTYSST	NTYSST	NTXSEL	NTXSMT 115V	NTXSPF	MX 2 zone	MX 3 zone	MX 4 zone	MX 5 zone	MX 8 zone	NTXSXS	MX 2 zone	MX 3 zone	MX 4 zone	MX 5 zone	MX 8 zone	NTXSXS	MX 2 zone	MX 3 zone	MX 4 zone	MX 5 zone	MX 8 zone		



P-SERIES																				
PKA-A12/18HA7 PKA-A24/30/36KA7			PCA-A24/30/36/42KA7							PEAD-A12/18/24/30/36/42AA7								PVA-A12/18/24/ 30/36/42AA7		
PUZ-A	PUY-A	PUZ-HA	PUZ-A	PUY-A	PUZ-HA	MX 3 zone	MX 4 zone	MX 5 zone	PUZ-A	PUY-A	PUZ-HA	MX 2 zone	MX 3 zone	MX 4 zone	MX 5 zone	MX 8 zone	PUZ-A	PUY-A	PUZ-HA	
			Opt	Opt	Opt	Opt	Opt	Opt												
									12	12	30/36						12	12	30/36	
	•	•	•	•	•				•	•	•						•	•	•	
			•	•	•	•	•	•												
			Opt	Opt	Opt	Opt	Opt	Opt												
			•	•	•	•	•	•	•	•	•	•	•	•	•	•				
	Opt	Opt	Opt	•	•	•	•	•	•	•	•	•	•	•	•	•				
	•	•	•	•	•	•	•	•												
	•	•	•	•	•	•	•	•	•	•	•	•	•	•	•	•	•	•	•	•
	•	•	•	•	•	•	•	•	•	•	•	•	•	•	•	•	•	•	•	•
	•	•	•	•	•	•	•	•	•	•	•	•	•	•	•	•	•	•	•	•
	•	•	•	•	•	•	•	•	•	•	•	•	•	•	•	•	•	•	•	•
	•	•	•	•	•	•	•	•	•	•	•	•	•	•	•	•	•	•	•	•
	• *2	• *2		• *2	• *2			• *1	• *1	• *2	• *2				• *1	• *1	•	• *2	• *2	

Opt: Separate parts must be purchased.

# Nv



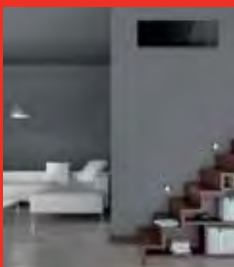









## Series



# LINE-UP

## HEAT PUMP

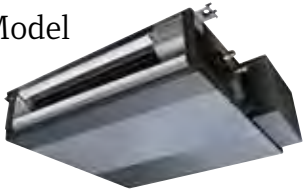
A multiple model line-up to choose from, each with various outstanding features. In addition to inverter-equipped wall-mounted models, floor-standing and multi-position air handlers can be selected. Choose the best style to match usage needs.

Wall-mounted Units		
<p>WPH Model</p>  <p>MX connection Pro-Heat</p>	<p>MSZ-EF Model</p>  <p>MX connection</p>	<p>WST Model</p>  <p>MX connection</p>
<p>WST Model</p> 	<p>WMT Model WMT 115V Model</p> 	<p>WEL Model</p> 
EZ FIT™ Ceiling Cassette Units	Multi-position Air Handler	Floor-mounted Units
<p>UKS Model</p>  <p>MX connection Pro-Heat</p>	<p>AMT Model</p>  <p>MX connection Pro-Heat</p>	<p>FKS Model</p>  <p>MX connection Pro-Heat</p>
Ceiling Cassette Unit	Horizontal-ducted Units	
<p>CKS Model</p>  <p>MX connection Pro-Heat</p>	<p>DKS Model</p>  <p>MX connection Pro-Heat</p>	<p>PEAD Model</p>  <p>MX connection Pro-Heat</p>

## COOLING ONLY

For applications with needs for only cooling, there are cooling-only models to choose from.

Wall-mounted Units	
<p>WST Model</p> 	



# WPH Model

The WPH Model is designed for optimum cooling/heating performance as well as operational comfort. Quiet, energy-saving operation is supported by some of our latest technologies. Advanced functions such as the 3D i-see Sensor® temperature control and Triple-action filtration raise room comfort levels to new heights.

NTXWPH(06/09/12/15/18)A112A\*  
NTXWPH18A112A\*



## ENERGY STAR® Certified for Entire Range of Series

The WPH Model has achieved an industry-leading efficiency of 33.1 SEER (NTXWPH06A112A\*) and 30.5 SEER (NTXWPH09A112A\*). All systems of the WPH Model feature high efficiencies and are ENERGY STAR® qualified, meaning that these units can save up to 25% on heating and cooling costs when installed correctly.

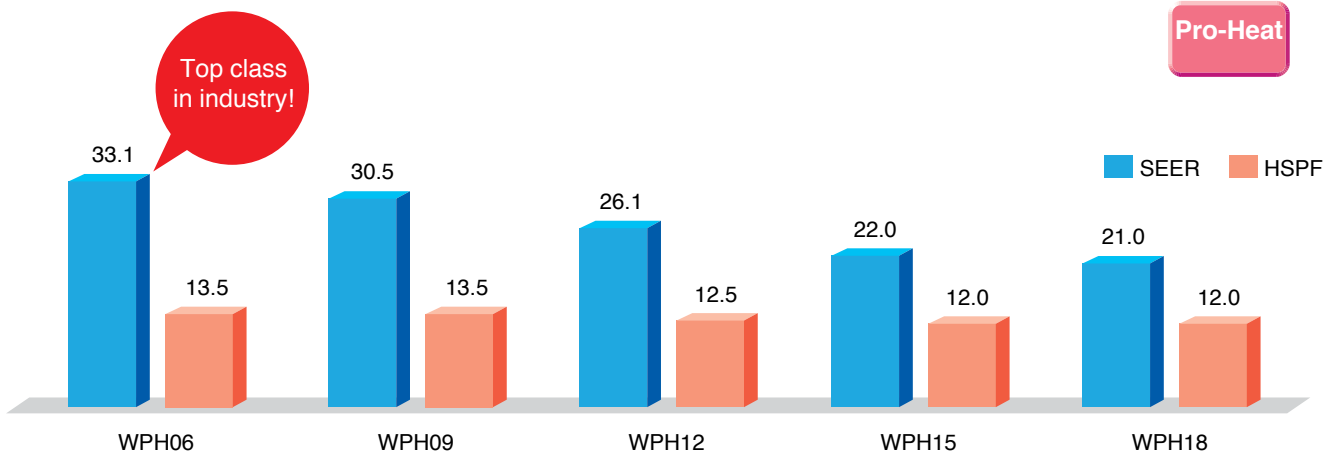

## Pro-Heat INVERTER®

The WPH Model can provide heating even when it's minus 13° F outdoor ambient, producing up to 100% heating capacity at 5° F. These units offer year-round comfort even in extreme climates.

Operation guaranteed at minus 13° F,  
100% heating capacity at 5° F

Base Heater equipped as standard\*

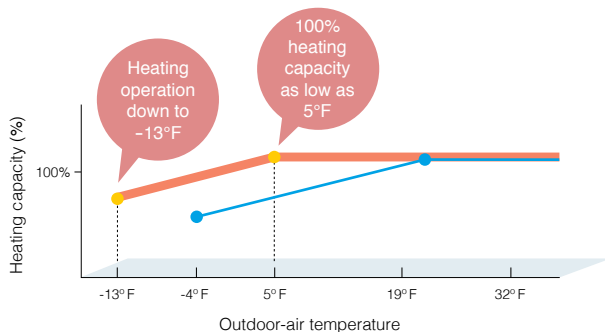

The base heater restricts lowered capacity and operation shutdowns caused by the drain water freezing. This supports stable operation in low-temperature environments.



Without base heater

With base heater

— NTXSPH  
— Standard Heat Pump

\*Standard for NTXSPB models  
Optional for NTXSPH models

# 3D i-see Sensor

The WPH Model is equipped with 3D i-see Sensor®, an infrared-ray Sensor that measures the temperature at distant positions. While moving to the left and right, eight vertically arranged Sensor elements analyze the room temperature in three dimensions. This detailed analysis makes it possible to judge where people are in the room, thus allowing creation of features such as Indirect Airflow, to avoid airflow hitting people directly, and Direct Airflow to deliver airflow to where people are located.

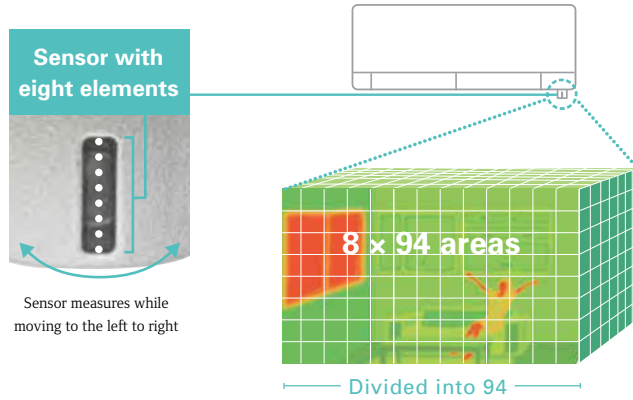

## Indirect Airflow

The Indirect Airflow setting can be used when the flow of air feels too strong or direct. For example, it can be used during cooling to avert airflow and prevent body temperature from becoming excessively cooled.

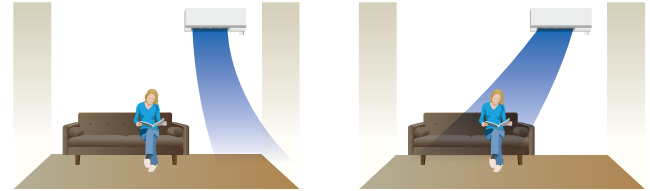

## Direct Airflow

This setting can be used to directly target airflow at people such as for immediate comfort when coming indoors on a hot (cold) day.

## Absence Detection

The Sensors detect whether there are people in the room. When no one is in the room the unit automatically switches to energy-saving mode.

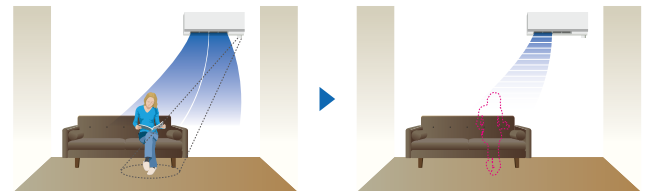

The 3D i-see Sensor detects people's absence and the power consumption is automatically reduced approximately 10% after 10 minutes and 20% after 60 minutes.

## Natural Flow

To create healthy airflow, the most important aspect is that the flow of air feels natural. Our solution to this is Natural Flow, thanks to our technology that freely and flexibly controls airflow.

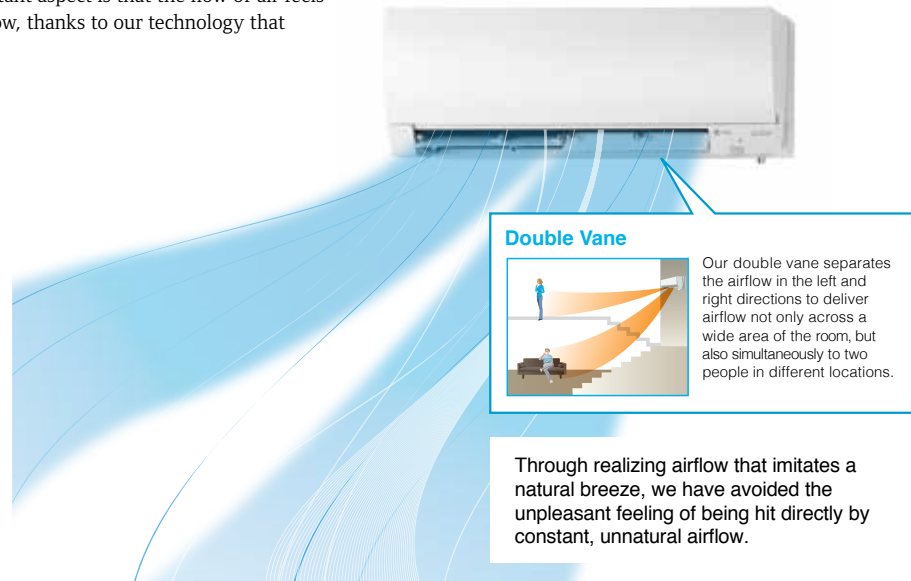
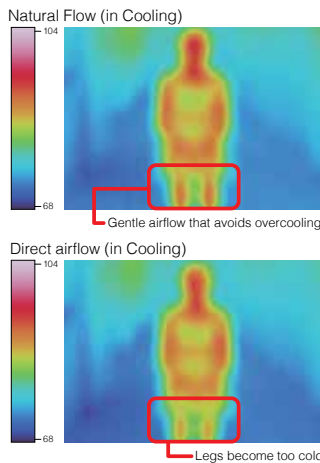

## Base data for Natural Flow



Kirigamine Highland is one of the most famous sightseeing spots in Japan, and is visited by a large number of people for its pleasant and comfortable environment. We have attempted to recreate this Kirigamine Highland comfort. As part of development, seeking to create a natural airflow, we measured actual data on the refreshing breezes of Kirigamine Highland. Through imitating the natural waveforms of this data, we have been able to recreate almost-imperceptible currents of gently comforting airflow.

## Analysis of natural wind

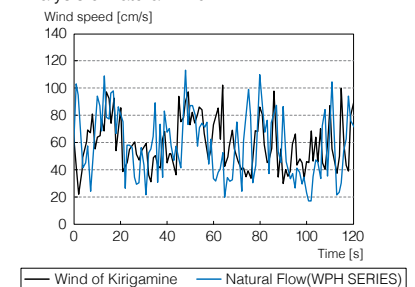

## Triple-action Filtration

Air, like water, is something we use every day unconsciously. Yet, clean, fresh air is a vital part of creating a healthy space for humans. Healthy air is achieved with three filters: the Nano Platinum filter, the Deodorizing filter, and the Electrostatic anti-allergy enzyme filter.

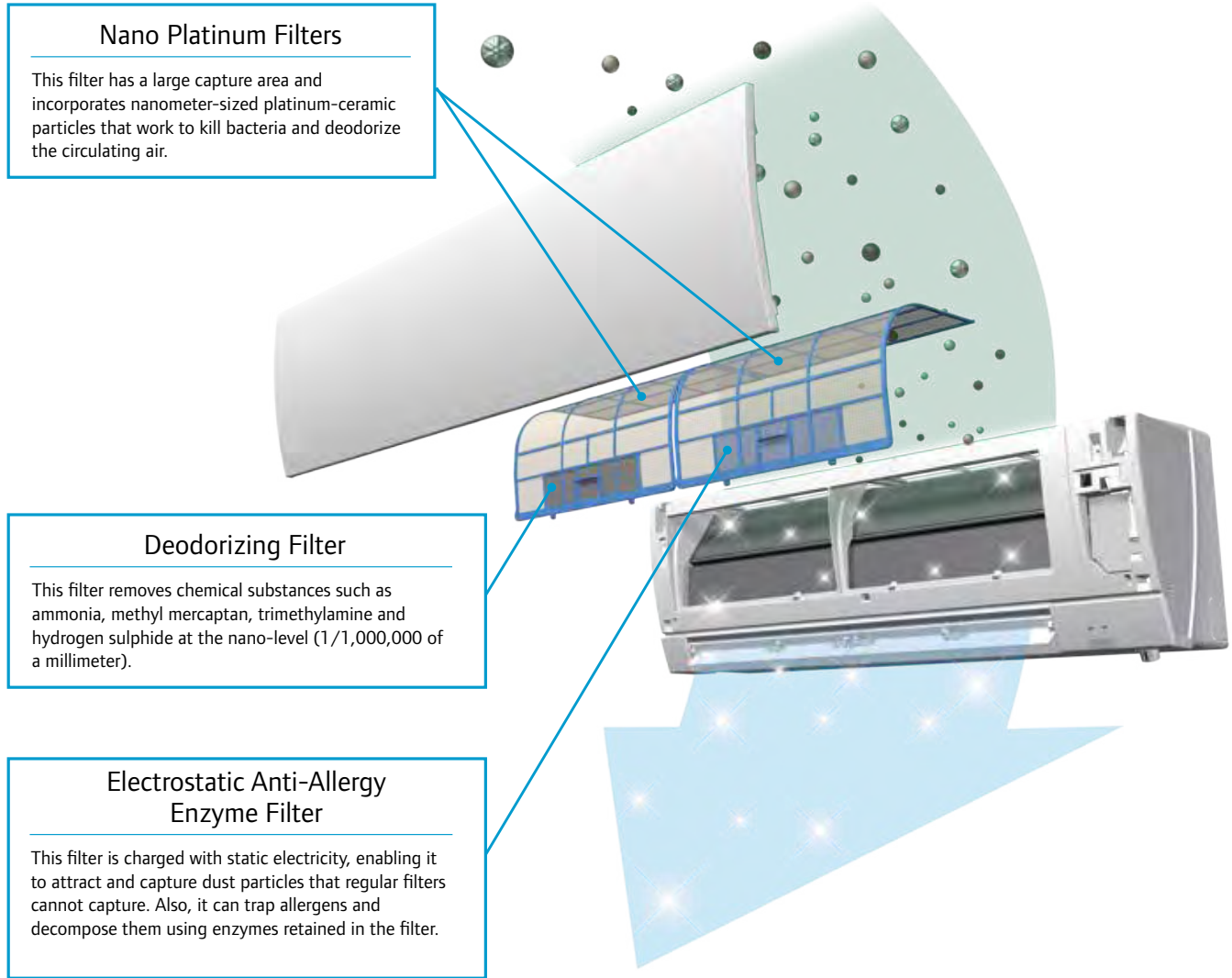

## Quiet Operation

The indoor unit noise level is as low as 20dB(A) for WPH06/09 models, offering a peaceful inside environment.

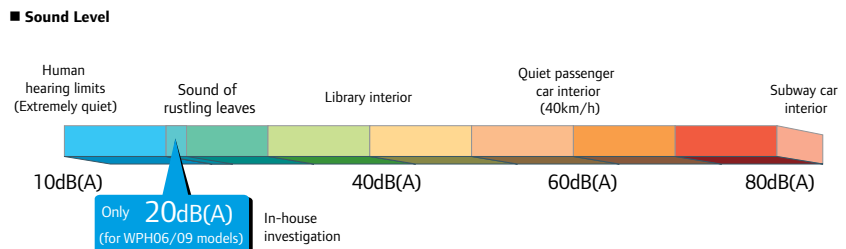

# WPH Model

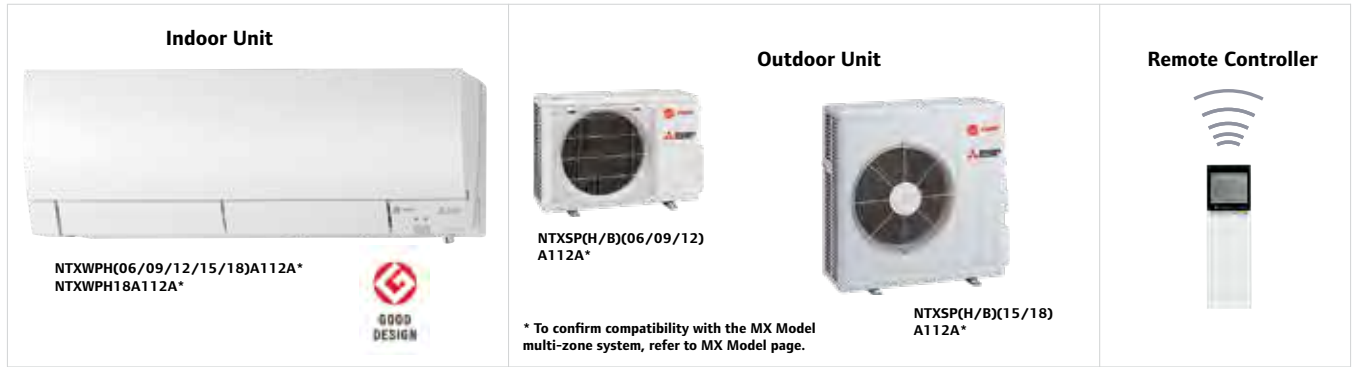

Indoor Unit				NTXWPH06A112A*	NTXWPH09A112A*	NTXWPH12A112A*	NTXWPH15A112A*	NTXWPH18A112A*
Outdoor Unit				NTXSPH06A112A*	NTXSPH09A112A*	NTXSPH12A112A*	NTXSPH15A112A*	NTXSPH18A112A*
Cooling	Capacity	Rated <sup>1</sup>	BTU/H	6,000	9,000	12,000	15,000	17,200
	Capacity Range	Min-Max	BTU/H	1,700-9,000	1,700-12,000	2,500-13,600	6,450-19,000	6,450-21,000
	Power Input	Rated <sup>1</sup>	W	315	560	870	1,200	1,375
	Moisture Removal	Pints/h		0.2	0.6	1.9	4.0	4.8
	Sensible Heat Factor			0.960	0.920	0.830	0.700	0.690
Heating	Capacity at 47°F	Rated <sup>2</sup>	BTU/H	8,700	10,900	13,600	18,000	20,300
	Capacity Range	Min-Max	BTU/H	1,600-14,000	1,600-18,000	3,700-21,000	5,150-24,000	5,150-30,000
	Power Input at 47°F	Rated <sup>2</sup>	W	545	710	950	1,300	1,720
	Capacity at 17°F	Rated <sup>3</sup>	BTU/H	5,900	6,700	8,000	11,000	13,700
	Capacity at 5°F	Max <sup>4</sup>	BTU/H	10,700	12,200	13,600	18,000	20,300
Efficiency	SEER			33.1	30.5	26.1	22.0	21.0
	EER			19.1	16.1	13.8	12.5	12.5
	HSPF			13.5 (12.5)	13.5 (12.5)	12.5 (11.5)	12.0 (11.0)	12.0 (11.0)
	COP			4.68	4.5	4.2	4.06	3.46
	ENERGY STAR <sup>®</sup> Certified			Yes	Yes	Yes	Yes	Yes
Indoor Unit	Air Flow Rate - Cooling (Quiet-Lo-Med-Hi-SHI)	Dry	CFM	137-167-221-304-381	137-167-221-304-381	137-167-221-304-398	225-262-304-355-411	225-262-304-355-459
		Wet	CFM	117-143-190-261-328	117-143-190-261-328	117-143-190-261-342	194-225-261-305-354	194-225-261-305-395
	Air Flow Rate - Heating (Quiet-Lo-Med-Hi-SHI)	Dry	CFM	140-167-225-325-437	140-167-225-325-437	140-167-225-325-454	201-254-317-394-497	201-254-317-394-514
	Sound Pressure Level (Quiet-Lo-Med-Hi-SHI)	Cooling	dB(A)	20-23-29-36-40	20-23-29-36-40	21-24-29-36-41	27-31-35-39-44	27-31-35-39-47
		Heating	dB(A)	20-24-29-36-42	20-24-29-36-42	21-24-29-36-42	25-29-34-39-46	25-29-34-36-46
	External Static Pressure		In. W.G.	—	—	—	—	—
	Condensate Lift Mechanism	Max Distance	In. [mm]	—	—	—	—	—
	Dimensions	H	In. [mm]	12 (+11/16) [305 (+17)]	12 (+11/16) [305]	12 (+11/16) [305 (+17)]	12 (+11/16) [305 (+17)]	12 (+11/16) [305 (+17)]
W		In. [mm]	36-7/16 [925]	36-7/16 [925]	36-7/16 [925]	36-7/16 [925]	36-7/16 [925]	
D		In. [mm]	9-3/16 [234]	9-3/16 [234]	9-3/16 [234]	9-3/16 [234]	9-3/16 [234]	
Weight		lbs [kg]	29 [13.5]	29 [13.5]	29 [13.5]	29 [13.5]	29 [13.5]	
Outdoor Unit	MCA	A		11.0	11.0	11.0	16.0	16.0
	MOCP	A		15	15	15	20	20
	Dimensions	H	In. [mm]	21-5/8 [550]	21-5/8 [550]	21-5/8 [550]	34-5/8 [880]	34-5/8 [880]
		W	In. [mm]	31-1/2 [800]	31-1/2 [800]	31-1/2 [800]	33-1/16 [840]	33-1/16 [840]
		D	In. [mm]	11-1/4 [285]	11-1/4 [285]	11-1/4 [285]	13 [330]	13 [330]
	Weight		lbs [kg]	81 [37]	81 [37]	83 [38]	124 [56]	124 [56]
	Air Flow Rate (Cooling/Heating)		CFM	1074/1202	1074/1202	1074/1202	1692/1634	1692/1634
Sound Pressure Level	Cooling	dB(A)	47	48	49	51	52	
	Heating	dB(A)	48	49	51	55	55	
Piping	Diameter	Gas (O.D.)	In. [mm]	1/4 [6.35]	1/4 [6.35]	1/4 [6.35]	1/4 [6.35]	1/4 [6.35]
		Liquid (O.D)	In. [mm]	3/8 [6.35]	3/8 [6.35]	3/8 [6.35]	1/2 [12.7]	1/2 [12.7]
		Indoor Drain	In. [mm]	5/8 [15.88]	5/8 [15.88]	5/8 [15.88]	5/8 [15.88]	5/8 [15.88]
	Max. Length		ft [m]	65 [20]	65 [20]	65 [20]	100 [30]	100 [30]
Max. Height		ft [m]	40 [12]	40 [12]	40 [12]	50 [15]	50 [15]	
Electrical	Outdoor-Indoor <sup>5</sup>	V, ph, Hz		208/230, 1, 60	208/230, 1, 60	208/230, 1, 60	208/230, 1, 60	208/230, 1, 60
	Recommended Breaker Size	A		15	15	15	20	20
Refrigerant Type				R410A	R410A	R410A	R410A	R410A
Guaranteed Temperature Operation Range	Cooling <sup>6</sup>	°F DB [°C DB]		14.0 to 115.0 [-10.0 to 46.0]	14.0 to 115.0 [-10.0 to 46.0]	14.0 to 115.0 [-10.0 to 46.0]	14.0 to 115.0 [-10.0 to 46.0]	14.0 to 115.0 [-10.0 to 46.0]
	Heating	°F DB [°C DB]		-13.0 to 75.0 [-25.0 to 24.0]	-13.0 to 75.0 [-25.0 to 24.0]	-13.0 to 75.0 [-25.0 to 24.0]	-13.0 to 75.0 [-25.0 to 24.0]	-13.0 to 75.0 [-25.0 to 24.0]

Notes:  
 AHRI Rated Conditions (Rated data is determined at a fixed compressor speed)  
 Conditions  
<sup>1</sup>Cooling (Indoor // Outdoor) °F 80 DB, 67 WB // 95 DB, 75 WB  
<sup>2</sup>Heating at 47°F (Indoor // Outdoor) °F 70 DB, 60 WB // 47 DB, 43 WB  
<sup>3</sup>Heating at 17°F (Indoor // Outdoor) °F 70 DB, 60 WB // 17 DB, 15 WB  
<sup>4</sup>Heating at 5°F (Indoor // Outdoor) °F 70 DB, 60 WB // 5 DB, 4 WB  
<sup>5</sup>Indoor units receive power from outdoor units through field-supplied interconnected wiring.  
<sup>6</sup>Applications should be restricted to comfort cooling only; equipment cooling applications are not recommended for low ambient temperature conditions.

# MSZ-EF Model

Developed to complement modern interior room décor, the EF Model are available in three colors specially chosen to blend in naturally wherever installed.



MSZ-EF09/12/15/18NAB/S/W

## A Stylish Line-up Matches Any Room Décor

The streamlined wall-mounted indoor units have eloquent edges, expressing sophistication and quality. Combining impressively low power consumption and quiet yet powerful performance, these units provide a best-match scenario for diverse interior designs while simultaneously ensuring maximum room and energy savings.



## Quiet Operation All Day Long

Our advanced Quiet Mode fan speed setting provides super-quiet operation as low as 21dB(A) for EF09/12 models. This unique feature makes the EF Model ideal for use in any situation.

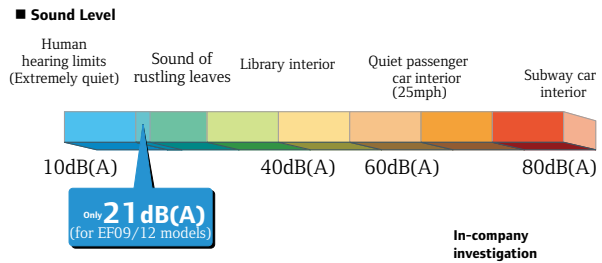

## Superior Exterior and Operating Design Concept

The indoor unit of the EF Model keeps its amazingly thin form even during operation. The only physical change notable is the movement of the variable vent. As a result, a slim attractive look is maintained.





# MSZ-EF Model



### Indoor Unit



**MSZ-EF09/12/15/18NAB\*** Glossy Black  
**MSZ-EF09/12/15/18NAS** Matte Silver  
**MSZ-EF09/12/15/18NAW** Glossy White

**\*Soft-dry Cloth is enclosed with Black models.**

### Outdoor Unit

For MX Connection Only

**\* To confirm compatibility with the MX Model multi-zone system, refer to MX Model page.**

### Remote Controller





Indoor Unit				MSZ-EF09NAW(S)(B)	MSZ-EF12NAW(S)(B)	MSZ-EF15NAW(S)(B)	MSZ-EF18NAW(S)(B)
Cooling	Capacity	Rated <sup>1</sup>	BTU/H	—	—	—	—
	Capacity Range	Min-Max	BTU/H	—	—	—	—
	Power Input	Rated <sup>1</sup>	W	—	—	—	—
	Moisture Removal	Pints/h		—	—	—	—
	Sensible Heat Factor			—	—	—	—
Heating	Capacity at 47°F	Rated <sup>2</sup>	BTU/H	—	—	—	—
	Capacity Range	Min-Max	BTU/H	—	—	—	—
	Power Input at 47°F	Rated <sup>2</sup>	W	—	—	—	—
	Capacity at 17°F	Rated <sup>3</sup>	BTU/H	—	—	—	—
	Capacity at 5°F	Max <sup>4</sup>	BTU/H	—	—	—	—
Efficiency	SEER			—	—	—	—
	EER			—	—	—	—
	HSPF			—	—	—	—
	COP			—	—	—	—
	ENERGY STAR <sup>®</sup> Certified			—	—	—	—
Indoor Unit	Air Flow Rate - Cooling (Quiet-Lo-Med-Hi-SHi)	Dry	CFM	141-162-222-293-371	141-162-222-293-371	205-233-272-314-364	205-240-279-328-388
		Wet	CFM	121-140-191-252-319	121-140-191-252-319	176-200-234-270-313	176-206-240-282-334
	Air Flow Rate - Heating (Quiet-Lo-Med-Hi-SHi)	Dry	CFM	141-162-219-314-420	141-162-219-314-448	194-222-275-350-448	226-258-318-392-466
		Heating	dB(A)	21-24-29-37-45	21-24-30-38-46	28-30-35-41-48	30-33-37-43-49
	Sound Pressure Level (Quiet-Lo-Med-Hi-SHi)	Cooling	dB(A)	21-23-29-36-42	21-24-29-36-42	28-31-35-39-42	30-33-36-40-43
		Heating	dB(A)	21-24-29-37-45	21-24-30-38-46	28-30-35-41-48	30-33-37-43-49
	External Static Pressure		In. W.G.	—	—	—	—
	Condensate Lift Mechanism	Max Distance	In. [mm]	—	—	—	—
		H	In. [mm]	11-3/4 [299]	11-3/4 [299]	11-3/4 [299]	11-3/4 [299]
	Dimensions	W	In. [mm]	34-13/16 [884]	34-13/16 [884]	34-13/16 [884]	34-13/16 [884]
D		In. [mm]	7-11/16 [195]	7-11/16 [195]	7-11/16 [195]	7-11/16 [195]	
Weight		lbs [kg]	26 [11.8]	26 [11.8]	26 [11.8]	26 [11.8]	
Outdoor Unit	MCA	A		—	—	—	—
	MOCP	A		—	—	—	—
	Dimensions	H	In. [mm]	—	—	—	—
		W	In. [mm]	—	—	—	—
		D	In. [mm]	—	—	—	—
	Weight	lbs [kg]		—	—	—	—
	Air Flow Rate (Cooling/Heating)	CFM		—	—	—	—
Sound Pressure Level	Cooling	dB(A)	—	—	—	—	
	Heating	dB(A)	—	—	—	—	
Piping	Diameter	Gas (O.D.)	In. [mm]	—	—	—	—
		Liquid (O.D)	In. [mm]	—	—	—	—
		Indoor Drain	In. [mm]	5/8 [15.88]	5/8 [15.88]	5/8 [15.88]	5/8 [15.88]
	Max. Length	ft [m]		—	—	—	—
Max. Height	ft [m]		—	—	—	—	
Electrical	Outdoor-Indoor <sup>5</sup>	V, ph, Hz		—	—	—	—
	Recommended Breaker Size	A		—	—	—	—
Refrigerant Type	Guaranteed Temperature Operation Range	°F DB [°C DB]		—	—	—	—
		°F DB [°C DB]		—	—	—	—

Notes:  
 AHRI Rated Conditions (Rated data is determined at a fixed compressor speed)  
 Conditions  
<sup>1</sup>Cooling (Indoor // Outdoor) °F 80 DB, 67 WB // 95 DB, 75 WB  
<sup>2</sup>Heating at 47°F (Indoor // Outdoor) °F 70 DB, 60 WB // 47 DB, 43 WB  
<sup>3</sup>Heating at 17°F (Indoor // Outdoor) °F 70 DB, 60 WB // 17 DB, 15 WB  
<sup>4</sup>Heating at 5°F (Indoor // Outdoor) °F 70 DB, 60 WB // 5 DB, 4 WB  
<sup>5</sup>Indoor units receive power from outdoor units through field-supplied interconnected wiring.  
<sup>6</sup>Applications should be restricted to comfort cooling only; equipment cooling applications are not recommended for low ambient temperature conditions.

# NT(X/Y)WST Model

Introducing a compact and stylish indoor unit with amazingly quiet performance. Not only are neat installations in small bedrooms, you can increase energy-savings by selecting the optimal capacity required for each room.



NT(X/Y)WST(30/36)A112A\*  
 NT(X/Y)WST24A112A\*  
 NT(X/Y)WST18A112A\*  
 NTXWST(06/09/12/15)A112A\*  
 NTYWST(09/12/15)A112A\*

## ENERGY STAR® Qualified for Entire Range of NT(X/Y)WST Model

All systems of the NTXWST and NTYWST Model feature high efficiencies and are ENERGY STAR® qualified.

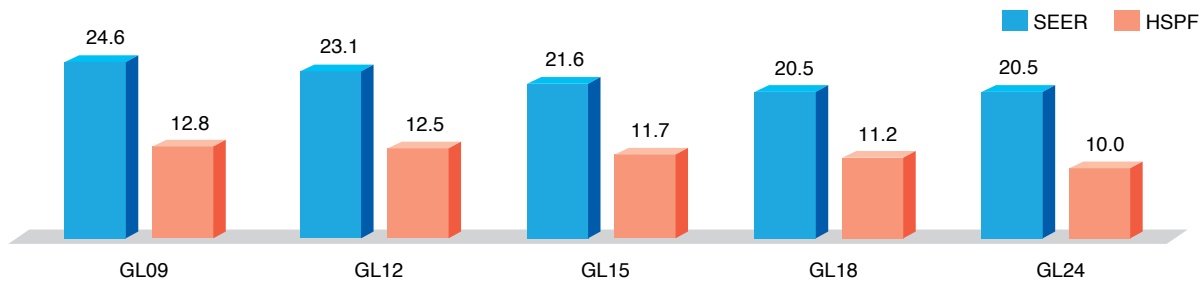

## Wide Line-up with Family Design

Eight different capacities (6,000 BTU/H to 36,000 BTU/H) are available to meet your diversified air conditioning needs, and all capacities from 6,000 BTU/H to 36,000 BTU/H indoor units have a family design. From small rooms to large living rooms, it is possible to coordinate residences with a unified design.



NTXWST(06/09/12/15)A112A\*  
 NTYWST(09/12/15)A112A\*



NT(X/Y)WST18A112A\*



NT(X/Y)WST24A112A\*



NT(X/Y)WST(30/36)A112A\*

## Compact Design

Slim and compact indoor units provide enhanced, industry-leading performance for cooling and heating.



## Quiet Operation

The indoor unit noise level is as low as 19dB(A) for WST09/12 models, offering a peaceful inside environment.

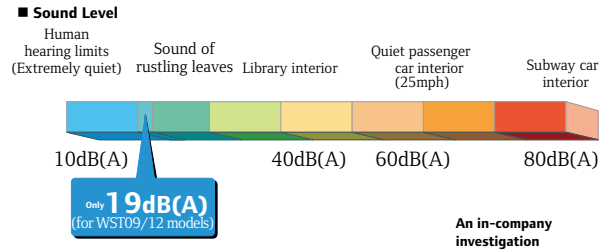

## Powerful Operation (WST24, WST30/36)

Depending on the capacity, the unit will automatically adjust the fan speed and set temperature for 15 minutes. Rapid cooling and heating will make the room comfortable more quickly.

Fan speed: Exclusive speed for POWERFUL mode.

Horizontal Vane: Set position, or downward airflow position during AUTO setting.



## Nano Platinum Filter (NTXWST06, NT(X/Y)WST09/12/15/18/24)

This filter generates stable antibacterial and deodorizing effects. The size of the three-dimensional surface has been increased as well, enlarging the filter capture area. These features give the Nano Platinum Filter better dust collection performance than conventional filters. The superior air cleaning effectiveness raises room comfort yet another level.

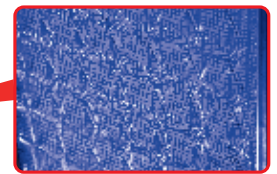
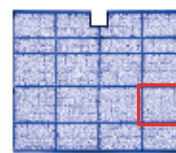

\* It is okay to wash the filter with water (air cleaning effect is maintained)

**3D surface (Waved surface)**

## Smart Set (NTXWST06, NT(X/Y)WST09/12/15/18/24)

Smart Set is a simplified setting function that recalls the preferred (pre-set) temperature by pressing a single button on the remote controller. Press the same button twice in repetition to immediately return to the previous temperature setting. Using this function contributes to comfortable, waste-free operation, realizing the most suitable air conditioning settings and saving on power consumption when, for example, leaving the room or going to bed.

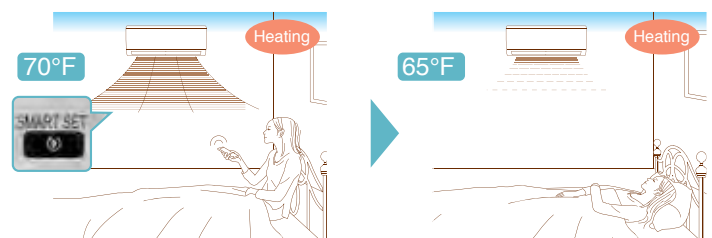



# NT(X/Y)WST Model



**Indoor Unit**  
NTXWST24A112A\*  
NTYWST24A112A\*

NTXWST(30/36)A112A\*  
NTYWST(30/36)A112A\*

**Outdoor Unit**  
NTXSST24A112A\*  
NTYSST24A112A\*

NTXSST30/36A112A\*  
NTYSST30/36A112A\*

\* To confirm compatibility with the MX Model multi-zone system, refer to MX Model page.

**Remote Controller**

Econo Cool

Blue Fin

Nano Platinum

Electrostatic Anti-allergy

Anti-allergy Enzyme

SWING

Wide

POWERFUL MODE

Smart Set

ACO

Auto Restart

Group Control

M-NET connection

USNAP

Wi-Fi

T-STAT

MX connection

Flare connection

Self Diagnosis

Failure Recall

Indoor Unit				NTXW-ST06A112A*	NTXW-ST09A112A*	NTXW-ST12A112A*	NTXW-ST15A112A*	NTXW-ST18A112A*	NTXW-ST24A112A*	NTXW-ST30A112A*	NTXW-ST36A112A*
Outdoor Unit				NTX-SS09A112A*	NTX-SS12A112A*	NTX-SS15A112A*	NTX-SS18A112A*	NTX-SS24A112A*	NTX-SS30A112A*	NTX-SS36A112A*	
Cooling	Capacity	Rated <sup>1</sup>	BTU/H	—	9,000	12,000	14,000	18,000	22,400	30,600	33,200
	Capacity Range	Min-Max	BTU/H	—	3,600–12,200	1,500–13,600	3,100–18,200	5,800–22,000	8,200–31,400	9,800–30,700	9,800–33,200
	Power Input	Rated <sup>1</sup>	W	—	585	920	1,080	1,340	1,800	3,850	4,360
	Moisture Removal	Pints/h		—	1.5	2.5	2.7	2.1	5.1	9.9	11.3
	Sensible Heat Factor			—	0.820	0.740	0.800	0.870	0.750	0.640	0.620
Heating	Capacity at 47°F	Rated <sup>2</sup>	BTU/H	—	10,900	14,400	18,000	21,600	27,600	32,600	35,200
	Capacity Range	Min-Max	BTU/H	—	4,500–15,900	2,000–18,100	4,800–20,900	5,400–25,000	7,500–36,900	8,700–34,000	8,700–36,000
	Power Input at 47°F	Rated <sup>2</sup>	W	—	720	1,100	1,600	1,680	2,340	3,360	3,840
	Capacity at 17°F	Rated <sup>3</sup>	BTU/H	—	6,700	9,200	12,200	13,800	16,000	19,500	21,800
		Max	BTU/H	—	10,200	12,000	16,400	18,200	24,600	20,800	22,800
Efficiency	SEER			—	24.6	23.1	21.6	20.5	20.5	14.5	14.5
	EER			—	15.4	13.0	13.0	13.4	12.5	8.0	7.6
	HSPF			—	12.8	12.5	11.7	11.2	10.0	8.2	8.2
	COP			—	4.44	3.84	3.3	3.77	3.46	2.84	2.69
	ENERGY STAR® Certified			—	Yes	Yes	Yes	Yes	Yes	No	No
Indoor Unit	Air Flow Rate - Cooling (Quiet-Lo-Med-Hi-SHi)	Dry	CFM	145–170–237–321–399	145–170–237–321–399	145–170–237–321–399	205–272–335–420–533	258–332–417–522–646	388–469–544–628–738	389–639–848–887	389–639–848–887
		Wet	CFM	109–134–201–286–364	109–134–201–286–364	109–134–201–286–364	170–237–300–385–498	232–299–375–470–581	347–420–487–562–661	350–576–763–798	350–576–763–798
	Air Flow Rate - Heating (Quiet-Lo-Med-Hi-SHi)	Dry	CFM	145–170–237–321–406	145–170–237–321–406	145–170–237–321–406	205–247–304–367–463	297–385–469–565–646	388–469–544–628–738	445–639–848–887	445–639–848–887
		Heating	CFM	19–22–30–37–43	19–22–30–37–43	19–22–30–37–43	26–32–38–44–49	28–33–38–44–49	34–41–45–49–53	32–42–49–51	32–42–49–51
	Sound Pressure Level (Quiet-Lo-Med-Hi-SHi)	Cooling	dB(A)	19–22–30–37–43	19–22–30–37–43	19–22–30–37–43	26–30–35–40–46	28–33–38–43–48	32–41–45–49–52	34–42–49–50	34–42–49–50
		Heating	dB(A)	19–22–30–37–43	19–22–30–37–43	19–22–30–37–43	26–30–35–40–46	28–33–38–43–48	32–41–45–49–52	34–42–49–50	34–42–49–50
	External Static Pressure		In. W.G.	—	—	—	—	—	—	—	—
	Condensate Lift Mechanism	Max Distance	In. [mm]	—	—	—	—	—	—	—	—
		H	In. [mm]	11-5/8 [295]	11-5/8 [295]	11-5/8 [295]	11-5/8 [295]	12 [305]	12-13/16 [325]	14-3/8 [365]	14-3/8 [365]
	Dimensions	W	In. [mm]	31-7/16 [798]	31-7/16 [798]	31-7/16 [798]	31-7/16 [798]	36-5/16 [923]	43-5/16 [1100]	46-1/16 [1170]	46-1/16 [1170]
D		In. [mm]	9-1/8 [232]	9-1/8 [232]	9-1/8 [232]	9-1/8 [232]	9-13/16 [250]	9-3/8 [238]	11-5/8 [295]	11-5/8 [295]	
Weight		lbs [kg]	22 [10.0]	22 [10.0]	22 [10.0]	22 [10.0]	28 [13.0]	37 [17.0]	40 [18.0]	40 [18.0]	
MCA	A		—	9.0	9.0	10.0	14.0	17.0	21.0	21.0	
MOCP	A		—	15	15	15	15	20	25	25	
Outdoor Unit	Dimensions	H	In. [mm]	—	21-5/8 [550]	21-5/9 [550]	21-5/10 [550]	34-5/8 [880]	34-5/8 [880]	33-7/16 [850]	33-7/16 [850]
		W	In. [mm]	—	31-1/2 [800]	31-1/2 [800]	31-1/4 [800]	33-1/16 [840]	33-1/16 [840]	33-1/16 [840]	33-1/16 [840]
		D	In. [mm]	—	11-1/4 [285]	11-1/5 [285]	11-1/6 [285]	13 [330]	13 [330]	13 [330]	13 [330]
	Weight	lbs [kg]	—	81 [37]	81 [37]	81 [37]	121 [55]	119 [54]	141 [64]	141 [64]	
Air Flow Rate (Cooling/Heating)	CFM		—	1229/1172	1229/1172	1243/1129	1691/1691	1769/1701	1941/1941	1941/1941	
Sound Pressure Level	Cooling	dB(A)	—	48	49	49	54	55	55	56	
	Heating	dB(A)	—	50	51	51	55	55	57	56	
Piping	Diameter	Gas (O.D.)	In. [mm]	—	3/8 [9.52]	3/8 [9.52]	1/2 [12.7]	1/2 [12.7]	5/8 [15.88]	5/8 [15.88]	5/8 [15.88]
		Liquid (O.D.)	In. [mm]	—	1/4 [6.35]	1/4 [6.35]	1/4 [6.35]	1/4 [6.35]	3/8 [9.52]	3/8 [9.52]	3/8 [9.52]
		Indoor Drain	In. [mm]	5/8 [15.88]	5/8 [15.88]	5/8 [15.88]	5/8 [15.88]	5/8 [15.88]	5/8 [15.88]	5/8 [15.88]	5/8 [15.88]
	Max. Length	ft [m]	—	65 [20]	65 [20]	65 [20]	100 [30]	100 [30]	100 [30]	100 [30]	
Max. Height	ft [m]	—	40 [12]	40 [12]	40 [12]	50 [15]	50 [15]	50 [15]	50 [15]		
Electrical	Outdoor-Indoor <sup>5</sup>	V, ph, Hz	—	208/230, 1, 60	208/230, 1, 60	208/230, 1, 60	208/230, 1, 60	208/230, 1, 60	208/230, 1, 60	208/230, 1, 60	208/230, 1, 60
	Recommended Breaker Size	A	—	15	15	15	15	20	25	25	
Refrigerant Type			—	R410A	R410A	R410A	R410A	R410A	R410A	R410A	
Guaranteed Temperature Operation Range	Cooling <sup>6</sup>	°F DB [°C DB]	—	14.0 to 115.0 [-10.0 to 46.0]	14.0 to 115.0 [-10.0 to 46.0]	14.0 to 115.0 [-10.0 to 46.0]	14.0 to 115.0 [-10.0 to 46.0]	14.0 to 115.0 [-10.0 to 46.0]	14.0 to 115.0 [-10.0 to 46.0]	14.0 to 115.0 [-10.0 to 46.0]	
	Heating	°F DB [°C DB]	—	-4.0 to 75.0 [-20.0 to 24.0]	-4.0 to 75.0 [-20.0 to 24.0]	-4.0 to 75.0 [-20.0 to 24.0]	-4.0 to 75.0 [-20.0 to 24.0]	-4.0 to 75.0 [-20.0 to 24.0]	-4.0 to 75.0 [-20.0 to 24.0]	-4.0 to 75.0 [-20.0 to 24.0]	

Notes:  
 AHRI Rated Conditions (Rated data is determined at a fixed compressor speed)  
 Conditions  
<sup>1</sup>Cooling (Indoor // Outdoor) °F 80 DB, 67 WB // 95 DB, 75 WB  
<sup>2</sup>Heating at 47°F (Indoor // Outdoor) °F 70 DB, 60 WB // 47 DB, 43 WB  
<sup>3</sup>Heating at 17°F (Indoor // Outdoor) °F 70 DB, 60 WB // 17 DB, 15 WB  
<sup>4</sup>Heating at 5°F (Indoor // Outdoor) °F 70 DB, 60 WB // 5 DB, 4 WB  
<sup>5</sup>Indoor units receive power from outdoor units through field-supplied interconnected wiring.  
<sup>6</sup>Applications should be restricted to comfort cooling only; equipment cooling applications are not recommended for low ambient temperature conditions.



# WMT Model

Compact, high-performance indoor and outdoor units and advanced inverter technologies provide superior energy savings and comfort in all rooms.

NTXWMT09/12/15A112A\*



NTXWMT18/24A112A\*



## Stylish Design with Flat Panel Front

A stylish flat panel design is employed for the front of the indoor unit. The simple look matches room aesthetics.



## Quiet Operation

Quiet, relaxing space is within reach. Operational noise is a low 22dB(A) (09/12 classes). Operation is so silent you might even forget the air conditioner is on.

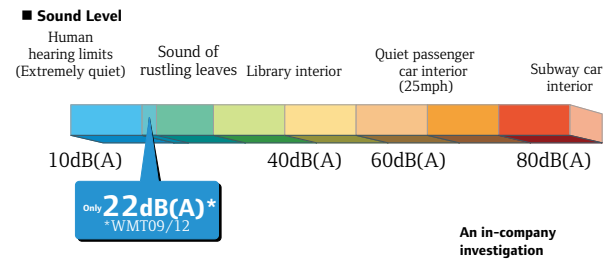

## Econo Cool Energy-Saving Feature

Econo Cool is an intelligent temperature control feature that adjusts the amount of air directed towards the body based on the air-outlet temperature. The setting temperature can be raised by as much as 4° F without any loss in comfort, thereby realizing a 20% gain in energy efficiency. (Function only available during manual cooling operation.)

	Conventional	Econo Cool
Ambient Temperature	95° F	95° F
Set Temperature	77° F	81° F
Perceived Temperature	86° F	85° F

## Econo Cool Mode

A comfortable room environment is maintained even when setting the temperature 4° F higher than the conventional cooling mode.

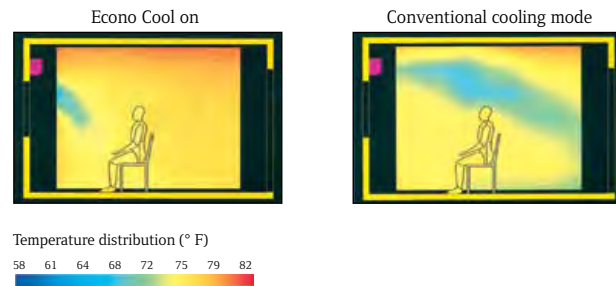

## Air Filter

This filter can remove dust particles from the air.

## 12-hour Timer

Allows for one ON/OFF cycle during a 12-hour period.

## Anti-allergy Enzyme Filter\*

(\*Optional)

This filter works to trap allergens such as bacteria and decompose them using enzymes retained in the filter.

## Blue Fin Condenser

Anti-corrosion treatment is done to the heat exchanger of the outdoor units. This coating prevents the corrosion of the aluminum fins caused by salt in the air especially in coastal areas. (Corrosion of the heat exchanger will effect the efficiency and performance of the air conditioner.)

# WMT Model



Indoor Unit				NTXWMT09A112A*	NTXWMT12A112A*	NTXWMT15A112A*	NTXWMT18A112A*	NTXWMT24A112A*
Outdoor Unit				NTXSMT09A112A*	NTXSMT12A112A*	NTXSMT15A112A*	NTXSMT18A112A*	NTXSMT24A112A*
Cooling	Capacity	Rated <sup>1</sup>	BTU/H	9,000	12,000	14,000	17,200	22,500
	Capacity Range	Min-Max	BTU/H	3,800-10,000	3,800-12,200	3,100-16,000	5,800-18,000	5,800-22,500
	Power Input	Rated <sup>1</sup>	W	750	1,210	1,170	1,640	2,630
	Moisture Removal	Pints/h		1.5	2.5	2.7	2.1	2.3
	Sensible Heat Factor			0.820	0.770	0.780	0.860	0.890
Heating	Capacity at 47°F	Rated <sup>2</sup>	BTU/H	10,900	12,200	18,000	18,000	26,000
	Capacity Range	Min-Max	BTU/H	4,500-11,800	4,500-14,500	4,800-18,500	5,400-20,900	5,400-26,000
	Power Input at 47°F	Rated <sup>2</sup>	W	900	990	1,600	1,590	2,500
	Capacity at 17°F	Rated <sup>3</sup>	BTU/H	6,700	7,600	11,500	11,500	18,500
	Capacity at 5°F	Max <sup>4</sup>	BTU/H	5,990	9,000	12,240	12,780	15,600
Efficiency	SEER			18.0	18.0	18.0	18.0	18.0
	EER			12.0	9.9	12.0	10.5	8.6
	HSPF			10	10	10	10	10
	COP			3.55	3.61	3.3	3.32	3.05
	ENERGY STAR <sup>®</sup> Certified			No	No	No	No	No
Indoor Unit	Air Flow Rate - Cooling (Quiet-Lo-Med-Hi-SH)	Dry	CFM	170-237-321-399	170-237-321-399	272-335-420-533	328-431-530-625	353-431-530-702
		Wet	CFM	134-201-286-364	134-201-286-364	237-300-385-498	295-388-477-562	318-388-477-632
	Air Flow Rate - Heating (Quiet-Lo-Med-Hi-SH)	Dry	CFM	170-237-321-406	170-237-321-406	247-304-367-463	307-431-530-625	346-448-579-702
		Cooling	dB(A)	22-30-37-43	22-30-37-45	32-38-44-49	30-37-42-47	33-38-44-50
	Sound Pressure Level (Quiet-Lo-Med-Hi-SH)	Heating	dB(A)	22-30-37-43	22-30-37-43	30-35-40-46	30-37-42-47	32-38-44-50
		External Static Pressure	In. W.G.		—	—	—	—
	Condensate Lift Mechanism	Max Distance	In. [mm]		—	—	—	—
		H	In. [mm]	11-5/8 [295]	11-5/8 [295]	11-5/8 [295]	12 [305]	12 [305]
	Dimensions	W	In. [mm]	31-7/16 [798]	31-7/16 [798]	31-7/16 [798]	36-5/16 [923]	36-5/16 [923]
		D	In. [mm]	9-1/8 [232]	9-1/8 [232]	9-1/8 [232]	9-13/16 [250]	9-13/16 [250]
Weight	lbs [kg]		22 [10.0]	22 [10.0]	22 [10.0]	28 [13.0]	28 [13.0]	
Outdoor Unit	MCA	A		9.0	9.0	10.0	10.0	14.0
		A		15	15	15	15	
	Dimensions	H	In. [mm]	21-5/8 [550]	21-5/8 [550]	21-5/8 [550]	21-5/8 [550]	34-5/8 [880]
		W	In. [mm]	31-1/2 [800]	31-1/2 [800]	31-1/2 [800]	31-1/2 [800]	33-1/16 [840]
		D	In. [mm]	11-1/4 [286]	11-1/4 [286]	11-1/4 [286]	11-1/4 [286]	13 [330]
Weight	lbs [kg]		73 [33.1]	73 [33.1]	81 [36.7]	81 [36.7]	121 [55]	
Air Flow Rate (Cooling/Heating)	CFM		1151/1225	1151/1225	1243/1229	1243/1229	1691/1691	
Sound Pressure Level	Cooling	dB(A)	46	49	49	50	54	
	Heating	dB(A)	50	51	51	51	55	
Piping	Diameter	Gas (O.D.)	In. [mm]	3/8 [9.52]	3/8 [9.52]	1/2 [12.7]	1/2 [12.7]	5/8 [15.88]
		Liquid (O.D.)	In. [mm]	1/4 [6.35]	1/4 [6.35]	1/4 [6.35]	1/4 [6.35]	3/8 [9.52]
		Indoor Drain	In. [mm]	5/8 [15.88]	5/8 [15.88]	5/8 [15.88]	5/8 [15.88]	5/8 [15.88]
	Max. Length	ft [m]		65 [20]	65 [20]	65 [20]	65 [20]	100 [30]
Max. Height	ft [m]		40 [12]	40 [12]	40 [12]	40 [12]	50 [15]	
Electrical	Outdoor-Indoor <sup>5</sup>	V, ph, Hz		208/230, 1, 60	208/230, 1, 60	208/230, 1, 60	208/230, 1, 60	208/230, 1, 60
	Recommended Breaker Size	A		15	15	15	15	15
Refrigerant Type				R410A	R410A	R410A	R410A	R410A
Guaranteed Temperature Operation Range	Cooling <sup>5</sup>	°F DB [°C DB]		14.0 to 115.0 [-10.0 to 46.0]	14.0 to 115.0 [-10.0 to 46.0]	14.0 to 115.0 [-10.0 to 46.0]	14.0 to 115.0 [-10.0 to 46.0]	14.0 to 115.0 [-10.0 to 46.0]
	Heating	°F DB [°C DB]		-4.0 to 75.0 [-20.0 to 24.0]	-4.0 to 75.0 [-20.0 to 24.0]	-4.0 to 75.0 [-20.0 to 24.0]	-4.0 to 75.0 [-20.0 to 24.0]	-4.0 to 75.0 [-20.0 to 24.0]

Notes:

- AHRI Rated Conditions<sup>1</sup> Cooling (Indoor // Outdoor) °F 80 DB, 67 WB // 95 DB, 75 WB
- (Rated data is determined at a fixed compressor speed)<sup>2</sup> Heating at 47°F (Indoor // Outdoor) °F 70 DB, 60 WB // 47 DB, 43 WB
- <sup>3</sup> Heating at 17°F (Indoor // Outdoor) °F 70 DB, 60 WB // 17 DB, 15 WB
- Conditions<sup>4</sup> Heating at 5°F (Indoor // Outdoor) °F 70 DB, 60 WB // 5 DB, 4 WB

<sup>5</sup>Indoor units receive power from outdoor units through field-supplied interconnected wiring.

<sup>6</sup>Applications should be restricted to comfort cooling only; equipment cooling applications are not recommended for low ambient temperature conditions.

# WMT 115V Model

The 115 volt single-zone WMT 115V Model is ideal for homes or businesses with electrical service restrictions.

NTXWMT(09/12)A111A\*



## Stylish Design with Flat Panel Front

A stylish flat panel design is employed for the front of the indoor unit. The simple look matches room aesthetics.



## Quiet Operation

Quiet, relaxing space is within reach. Operational noise is a low 22dB(A) (09/12 classes). Operation is so silent you might even forget the air conditioner is on.

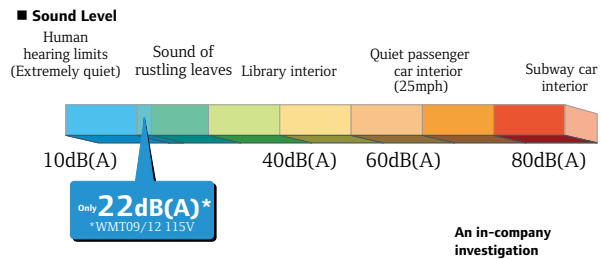

## Econo Cool Energy-Saving Feature

Econo Cool is an intelligent temperature control feature that adjusts the amount of air directed towards the body based on the air-outlet temperature. The setting temperature can be raised by as much as 4° F without any loss in comfort, thereby realizing a 20% gain in energy efficiency. (Function only available during manual cooling operation.)

	Conventional	Econo Cool
Ambient Temperature	95° F	95° F
Set Temperature	77° F	81° F
Perceived Temperature	86° F	85° F

## Econo Cool Mode

A comfortable room environment is maintained even when setting the temperature 4° F higher than the conventional cooling mode.

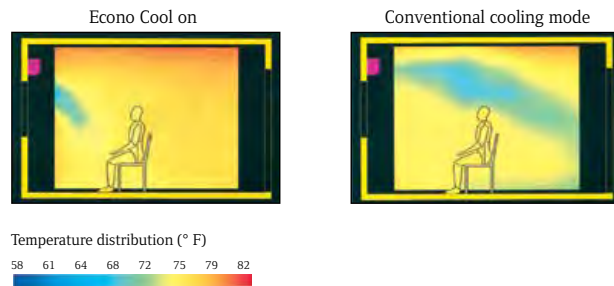

## Air Filter

This filter can remove dust particles from the air.

## 12-hour Timer

Allows for one ON/OFF cycle during a 12-hour period.

## Anti-allergy Enzyme Filter\*

(\*Optional)

This filter works to trap allergens such as bacteria and decompose them using enzymes retained in the filter.

## Blue Fin Condenser

Anti-corrosion treatment is done to the heat exchanger of the outdoor units. This coating prevents the corrosion of the aluminum fins caused by salt in the air especially in coastal areas. (Corrosion of the heat exchanger will effect the efficiency and performance of the air conditioner.)

# WMT 115V Model



Indoor Unit				NTXWMT09A111A*				NTXWMT12A111A*			
Outdoor Unit				NTXSMT09A111A*				NTXSMT12A111A*			
Cooling	Capacity	Rated <sup>1</sup>	BTU/H	9,000				12,000			
	Capacity Range	Min-Max	BTU/H	3,800-10,000				3,800-12,000			
	Power Input	Rated <sup>1</sup>	W	750				1,210			
	Moisture Removal	Pints/h		1.5				2.5			
	Sensible Heat Factor			0.820				0.770			
Heating	Capacity at 47°F	Rated <sup>2</sup>	BTU/H	10,900				12,200			
	Capacity Range	Min-Max	BTU/H	4,500-11,800				4,500-14,500			
	Power Input at 47°F	Rated <sup>2</sup>	W	900				900			
	Capacity at 17°F	Rated <sup>3</sup>	BTU/H	6,700				7,600			
	Capacity at 5°F	Max <sup>4</sup>	BTU/H	5,990				7,440			
Efficiency	SEER			17.0				17.0			
	EER			12.0				9.9			
	HSPF			9				9			
	COP			3.55				3.61			
	ENERGY STAR <sup>®</sup> Certified			No				No			
Indoor Unit	Air Flow Rate - Cooling (Quiet-Lo-Med-Hi-SHi)	Dry	CFM	170-237-321-399				170-237-321-399			
		Wet	CFM	134-201-286-364				134-201-286-364			
	Air Flow Rate - Heating (Quiet-Lo-Med-Hi-SHi)	Dry	CFM	170-237-321-406				170-237-321-406			
		Cooling	dB(A)	22-30-37-43				22-30-37-43			
	Sound Pressure Level (Quiet-Lo-Med-Hi-SHi)	Heating	dB(A)	22-30-37-43				22-30-37-43			
		External Static Pressure		In. W.G.	-				-		
	Condensate Lift Mechanism	Max Distance	In. [mm]	-				-			
		Dimensions	H	In. [mm]	11-5/8 [295]				11-5/8 [295]		
	W		In. [mm]	31-7/16 [798]				31-7/16 [798]			
	D		In. [mm]	9-1/8 [232]				9-1/8 [232]			
Weight	lbs [kg]		22 [10]				22 [10]				
Outdoor Unit	MCA	A		12.0				14.0			
	MOCF	A		15				15			
	Dimensions	H	In. [mm]	21-5/8 [550]				21-5/8 [550]			
		W	In. [mm]	31-1/2 [800]				31-1/2 [800]			
		D	In. [mm]	11-1/4 [285]				11-1/4 [285]			
	Weight	lbs [kg]		81 [37]				81 [37]			
	Air Flow Rate (Cooling/Heating)	CFM		1105/1225				1105/1225			
	Sound Pressure Level	Cooling	dB(A)	46				49			
Heating		dB(A)	46				50				
Piping	Diameter	Gas (O.D.)	In. [mm]	3/8 [9.52]				3/8 [9.52]			
		Liquid (O.D)	In. [mm]	1/4 [6.35]				1/4 [6.35]			
		Indoor Drain	In. [mm]	5/8 [15.88]				5/8 [15.88]			
	Max. Length	ft [m]		40 [12]				40 [12]			
Max. Height	ft [m]		65 [20]				65 [20]				
Electrical	Outdoor-Indoor <sup>5</sup>	V, ph, Hz		115, 1, 60				115, 1, 60			
	Recommended Breaker Size	A		15				15			
Refrigerant Type				R410A				R410A			
Guaranteed Temperature Operation Range	Cooling <sup>6</sup>	°F DB [°C DB]		14.0 to 115.0 [-10.0 to 46.0]				14.0 to 115.0 [-10.0 to 46.0]			
	Heating	°F DB [°C DB]		-4.0 to 75.0 [-20.0 to 24.0]				-4.0 to 75.0 [-20.0 to 24.0]			

**Notes:**

- AHRI Rated Conditions <sup>1</sup>Cooling (Indoor // Outdoor) °F 80 DB, 67 WB // 95 DB, 75 WB
- (Rated data is determined at a fixed compressor speed) <sup>2</sup>Heating at 47°F (Indoor // Outdoor) °F 70 DB, 60 WB // 47 DB, 43 WB
- Conditions <sup>3</sup>Heating at 17°F (Indoor // Outdoor) °F 70 DB, 60 WB // 17 DB, 15 WB
- <sup>4</sup>Heating at 5°F (Indoor // Outdoor) °F 70 DB, 60 WB // 5 DB, 4 WB
- <sup>5</sup>Indoor units receive power from outdoor units through field-supplied interconnected wiring.
- <sup>6</sup>Applications should be restricted to comfort cooling only; equipment cooling applications are not recommended for low ambient temperature conditions.

# WEL MODEL

The WEL Model is a basic 16 SEER INVERTER-driven heat pump.

## Stylish Design with Flat Panel Front

A stylish flat panel design is employed for the front of the indoor unit. The simple look matches room aesthetics.



## Econo Cool Energy-Saving Feature

Econo Cool is an intelligent temperature control feature that adjusts the amount of air directed towards the body based on the air-outlet temperature. The setting temperature can be raised by as much as 4° F without any loss in comfort, thereby realizing a 20% gain in energy efficiency. (Function only available during manual cooling operation.)

	Conventional	Econo Cool
Ambient Temperature	95° F	95° F
Set Temperature	77° F	81° F
Perceived Temperature	86° F	85° F

## Air Filter

This filter can remove dust particles from the air.

## Anti-allergy Enzyme Filter\*

(\*Optional)

This filter works to trap allergens such as bacteria and decompose them using enzymes retained in the filter.

NTXWEL09/12A112A\*



NTXWEL18/24A112A\*



## Quiet Operation

Quiet, relaxing space is within reach. Operational noise is a low 22dB(A) (09/12 classes). Operation is so silent you might even forget the air conditioner is on.

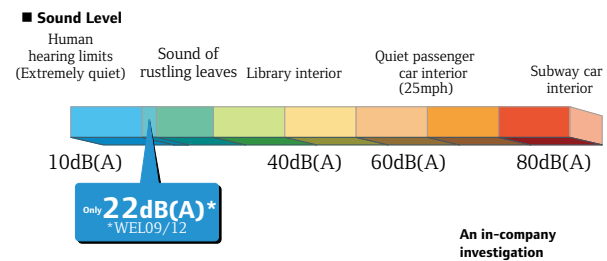

## Econo Cool Mode

A comfortable room environment is maintained even when setting the temperature 4° F higher than the conventional cooling mode.

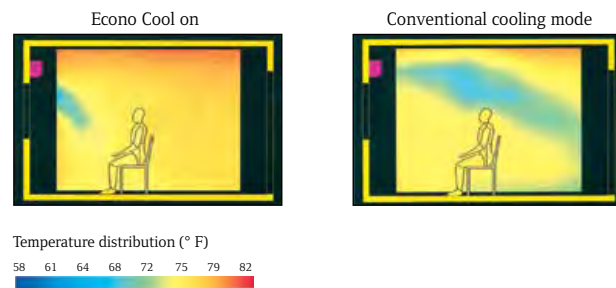

## 12-hour Timer

Allows for one ON/OFF cycle during a 12-hour period.

## Blue Fin Condenser

Anti-corrosion treatment is done to the heat exchanger of the outdoor units. This coating prevents the corrosion of the aluminum fins caused by salt in the air especially in coastal areas. (Corrosion of the heat exchanger will effect the efficiency and performance of the air conditioner.)



# WEL Model



Indoor Unit			NTXWEL09/12A112A*		NTXWEL12A112A*		NTXWEL18A112A*		NTXWEL24A112A*	
Outdoor Unit			NTXSEL09A112A*		NTXSEL12A112A*		NTXSEL18A112A*		NTXSEL24A112A*	
Cooling	Capacity	Rated <sup>1</sup>	BTU/H	9,000	12,000	17,200	22,500			
	Capacity Range	Min-Max	BTU/H	3,800-10,000	3,800-12,200	5,800-18,000	5,800-22,500			
	Power Input	Rated <sup>1</sup>	W	820	1,330	1,720	2,810			
	Moisture Removal	Pints/h		1.5	2.5	2.1	2.3			
	Sensible Heat Factor			0.820	0.770	0.860	0.890			
Heating	Capacity at 47°F	Rated <sup>2</sup>	BTU/H	10,900	12,200	18,000	26,000			
	Capacity Range	Min-Max	BTU/H	4,500-11,800	4,500-14,500	5,400-20,900	5,400-26,000			
	Power Input at 47°F	Rated <sup>2</sup>	W	980	1,090	1,670	2,680			
	Capacity at 17°F	Rated <sup>3</sup>	BTU/H	6,700	7,600	11,500	18,500			
	Capacity at 5°F	Max <sup>4</sup>	BTU/H	5,990	7,440	12,780	15,600			
Efficiency	SEER			16.0	16.0	16.0	16.0			
	EER			11.0	9.0	10.0	8.0			
	HSPF			8.5	8.5	8.5	8.5			
	COP			3.25	3.28	3.16	2.84			
	ENERGY STAR <sup>®</sup> Certified			No	No	No	No			
Indoor Unit	Air Flow Rate - Cooling (Quiet-Lo-Med-Hi-SHI)	Dry	CFM	170-237-321-399	170-237-321-399	328-431-530-625	353-431-530-702			
		Wet	CFM	134-201-286-364	134-201-286-364	295-388-477-562	318-388-477-632			
	Air Flow Rate - Heating (Quiet-Lo-Med-Hi-SHI)	Dry	CFM	170-237-321-406	170-237-321-406	307-431-530-625	346-448-579-702			
		Heating	dB(A)	22-30-37-43	22-30-37-43	30-37-42-47	32-38-44-50			
	Sound Pressure Level (Quiet-Lo-Med-Hi-SHI)	Cooling	dB(A)	22-30-37-43	22-30-37-43	30-37-42-47	32-38-44-50			
	External Static Pressure		In. W.G.	—	—	—	—			
	Condensate Lift Mechanism	Max Distance	In. [mm]	—	—	—	—			
		H	In. [mm]	11-5/8 [295]	11-5/8 [295]	12 [305]	12 [305]			
	Dimensions	W	In. [mm]	31-7/16 [798]	31-7/16 [798]	36-5/16 [923]	36-5/16 [923]			
		D	In. [mm]	9-1/8 [232]	9-1/8 [232]	9-13/16 [250]	9-13/16 [250]			
Weight	lbs [kg]		22 [10]	22 [10]	28 [13]	28 [13]				
MCA	A		9.0	9.0	10.0	14.0				
MOCP	A		15	15	15	15				
Outdoor Unit	Dimensions	H	In. [mm]	21-5/8 [550]	21-5/8 [550]	34-5/8 [880]	34-5/8 [880]			
		W	In. [mm]	31-1/2 [800]	31-1/2 [800]	33-1/16 [840]	31-1/16 [840]			
	D	In. [mm]	11-1/4 [286]	11-1/4 [286]	13 [330]	13 [330]				
	Weight	lbs [kg]		73 [33.1]	73 [33.1]	81 [36.7]	121 [54.9]			
Air Flow Rate (Cooling/Heating)	CFM		1151/1225	1151/1225	1243/1229	1691/1691				
Sound Pressure Level	Cooling	dB(A)	48	51	53	57				
	Heating	dB(A)	50	51	51	55				
Piping	Diameter	Gas (O.D.)	In. [mm]	3/8 [9.52]	3/8 [9.52]	1/2 [12.7]	5/8 [15.88]			
		Liquid (O.D)	In. [mm]	1/4 [6.35]	1/4 [6.35]	1/4 [6.35]	3/8 [9.52]			
		Indoor Drain	In. [mm]	5/8 [15.88]	5/8 [15.88]	5/8 [15.88]	5/8 [15.88]			
	Max. Length	ft [m]		40 [12]	40 [12]	40 [12]	50 [15]			
Max. Height	ft [m]		65 [20]	65 [20]	65 [20]	100 [30]				
Electrical	Outdoor-Indoor <sup>5</sup>	V, ph, Hz		208/230, 1, 60	208/230, 1, 60	208/230, 1, 60	208/230, 1, 60			
	Recommended Breaker Size	A		15	15	15	15			
Refrigerant Type				R410A	R410A	R410A	R410A			
Guaranteed Temperature Operation Range	Cooling <sup>6</sup>	°F DB [°C DB]		32.0 to 115.0 [-10.0 to 46.0]	32.0 to 115.0 [-10.0 to 46.0]	32.0 to 115.0 [-10.0 to 46.0]	32.0 to 115.0 [-10.0 to 46.0]			
	Heating	°F DB [°C DB]		5.0 to 75.0 [-20.0 to 24.0]	5.0 to 75.0 [-20.0 to 24.0]	5.0 to 75.0 [-20.0 to 24.0]	5.0 to 75.0 [-20.0 to 24.0]			

Notes:

- AHRI Rated Conditions (Rated data is determined at a fixed compressor speed)
  - <sup>1</sup>Cooling (Indoor // Outdoor) °F 80 DB, 67 WB // 95 DB, 75 WB
  - <sup>2</sup>Heating at 47°F (Indoor // Outdoor) °F 70 DB, 60 WB // 47 DB, 43 WB
  - <sup>3</sup>Heating at 17°F (Indoor // Outdoor) °F 70 DB, 60 WB // 17 DB, 15 WB
- Conditions
  - <sup>4</sup>Heating at 5°F (Indoor // Outdoor) °F 70 DB, 60 WB // 5 DB, 4 WB
- <sup>5</sup>Indoor units receive power from outdoor units through field-supplied interconnected wiring.
- <sup>6</sup>Applications should be restricted to comfort cooling only; equipment cooling applications are not recommended for low ambient temperature conditions.

# FKS Model

High capacity, energy savings and a design that harmonizes with living spaces raise the value of your room to the next level.

NTXFKS(09/12/15/18)A112A\*



## Simple Flat Design

Uneven surfaces have been smoothed to provide a simple design with linear beauty, harmonized with all types of interiors.

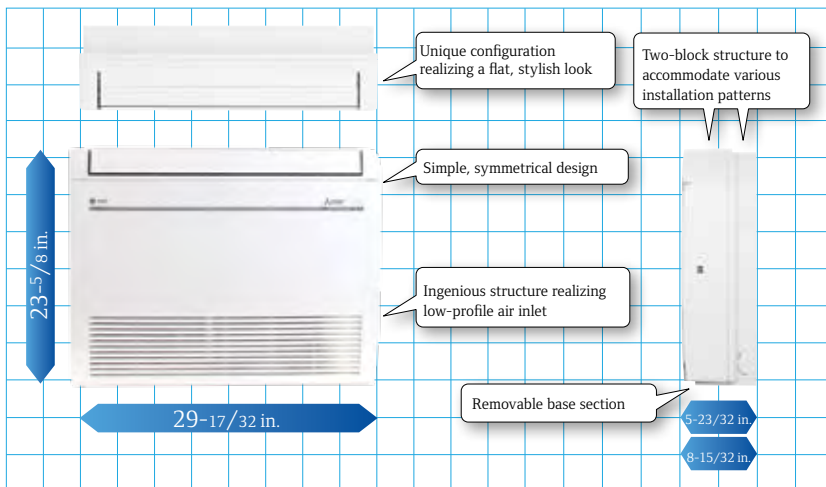

### Images of installed unit

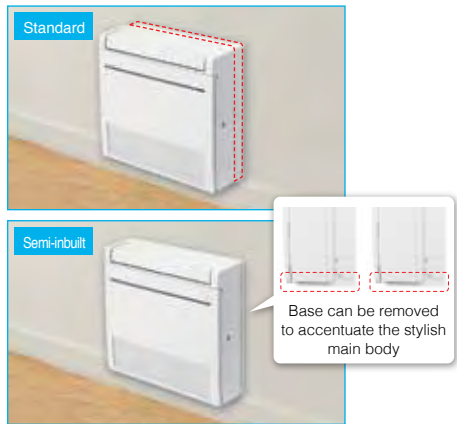

## Multi-flow Vane

Three uniquely shaped vanes control the airflow and allow the freedom to customize comfort according to preferences.

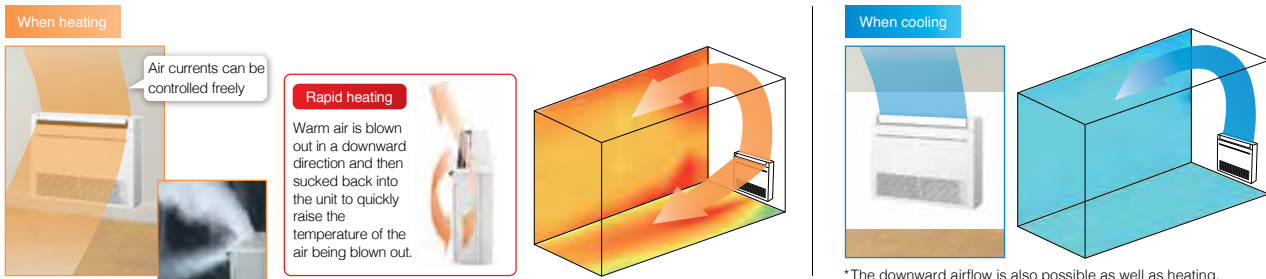

### Air Distribution (NTXFKS15A112AA) (sectional view)

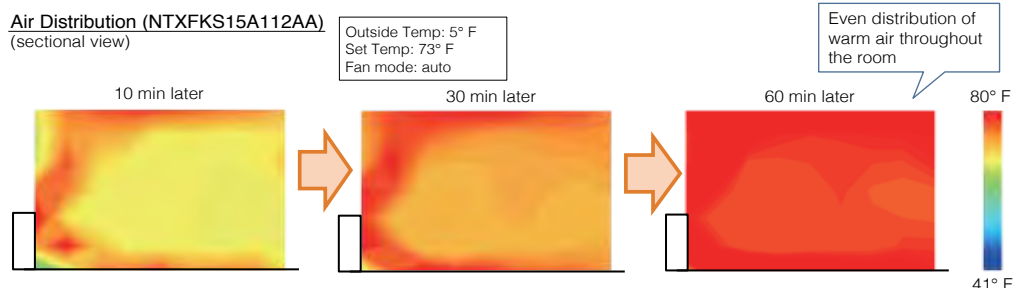

# FKS Model



<b>Indoor Unit</b>    <b>NTXFKS(09/12/15/18) A112A*</b>		<b>Outdoor Unit</b>    <b>NTXFKS(15/18)A112A*</b>	  <b>NTXFKS(09/12)A112A*</b>  <b>* To confirm compatibility with the MX Model multi-zone system, refer to MX Model page.</b>	
<div style="display: flex; justify-content: space-between; align-items: center;"> <div style="display: flex; gap: 5px;"> <div style="border: 1px solid black; padding: 2px; font-size: 8px;">Econo Cool</div> <div style="border: 1px solid black; padding: 2px; font-size: 8px;">Blue Fin</div> <div style="border: 1px solid black; padding: 2px; font-size: 8px;">Nano Platinum</div> <div style="border: 1px solid black; padding: 2px; font-size: 8px;">Anti-allergy Enzyme</div> <div style="border: 1px solid black; padding: 2px; font-size: 8px;">SWING</div> <div style="border: 1px solid black; padding: 2px; font-size: 8px;">POWERFUL MODE</div> <div style="border: 1px solid black; padding: 2px; font-size: 8px;">AUTO</div> <div style="border: 1px solid black; padding: 2px; font-size: 8px;">Weekly Timer</div> <div style="border: 1px solid black; padding: 2px; font-size: 8px;">Smart Set</div> <div style="border: 1px solid black; padding: 2px; font-size: 8px;">ACO</div> <div style="border: 1px solid black; padding: 2px; font-size: 8px;">Auto Restart</div> <div style="border: 1px solid black; padding: 2px; font-size: 8px;">Low Temp Cooling</div> <div style="border: 1px solid black; padding: 2px; font-size: 8px;">Sleep</div> <div style="border: 1px solid black; padding: 2px; font-size: 8px;">Group Control</div> <div style="border: 1px solid black; padding: 2px; font-size: 8px;">M-NET connection</div> </div> <div style="display: flex; gap: 5px; margin-top: 5px;"> <div style="border: 1px solid black; padding: 2px; font-size: 8px;">USNAP</div> <div style="border: 1px solid black; padding: 2px; font-size: 8px;">Wi-Fi</div> <div style="border: 1px solid black; padding: 2px; font-size: 8px;">T-STAT</div> <div style="border: 1px solid black; padding: 2px; font-size: 8px;">MX connection</div> <div style="border: 1px solid black; padding: 2px; font-size: 8px;">Cleaning pipe robot</div> <div style="border: 1px solid black; padding: 2px; font-size: 8px;">Flare connection</div> <div style="border: 1px solid black; padding: 2px; font-size: 8px;">Self Diagnosis</div> <div style="border: 1px solid black; padding: 2px; font-size: 8px;">Failure Recall</div> <div style="border: 1px solid black; padding: 2px; font-size: 8px;">Hi</div> </div> </div>				

Indoor Unit				NTXFKS09A112A*	NTXFKS12A112A*	NTXFKS15A112A*	NTXFKS18A112A*
Outdoor Unit				NTXSPP09A112A*	NTXSPP12A112A*	NTXSPP15A112A*	NTXSPP18A112A*
Cooling	Capacity	Rated <sup>1</sup>	BTU/H	9,000	12,000	15,000	17,000
	Capacity Range	Min-Max	BTU/H	2,300-14,000	2,300-15,000	5,300-19,000	5,300-22,500
	Power Input	Rated <sup>1</sup>	W	570	890	1,120	1,350
	Moisture Removal	Pints/h		1.4	2.7	3.9	4.4
	Sensible Heat Factor			0.790	0.700	0.660	0.650
Heating	Capacity at 47°F	Rated <sup>2</sup>	BTU/H	11,000	13,000	18,000	21,000
	Capacity Range	Min-Max	BTU/H	2,900-19,000	2,900-22,800	5,700-25,000	5,700-29,000
	Power Input at 47°F	Rated <sup>2</sup>	W	750	900	1,410	1,730
	Capacity at 17°F	Rated <sup>3</sup>	BTU/H	7,500	8,800	12,000	12,800
		Max	BTU/H	13,400	14,800	20,500	23,000
Capacity at 5°F	Max <sup>4</sup>	BTU/H	11,000	13,000	18,000	21,000	
Efficiency	SEER			28.2	25.5	21.8	21.0
	EER			15.8	13.6	13.5	12.6
	HSPF			13	12	11.6	11.3
	COP			4.3	4.2	3.7	3.5
	ENERGY STAR <sup>®</sup> Certified			Yes	Yes	Yes	Yes
Indoor Unit	Air Flow Rate - Cooling (Quiet-Lo-Med-Hi-SHI)	Dry	CFM	138-198-272-360-417	138-198-272-360-417	198-254-311-392-431	198-254-328-420-491
		Wet	CFM	117-168-231-306-354	117-168-231-306-354	168-216-264-333-366	168-216-279-357-417
	Air Flow Rate - Heating (Quiet-Lo-Med-Hi-SHI)	Dry	CFM	138-191-254-328-417	138-191-254-328-417	212-268-328-399-470	212-268-328-399-470
		Heating	dB(A)	21-27-34-41-46	21-27-34-41-46	28-33-38-43-47	28-33-39-45-50
	Sound Pressure Level (Quiet-Lo-Med-Hi-SHI)	Cooling	dB(A)	21-27-34-41-46	21-27-34-41-46	29-35-40-45-49	29-35-40-45-49
		Heating	dB(A)	21-27-34-41-46	21-27-34-41-46	29-35-40-45-49	29-35-40-45-49
	External Static Pressure		In. W.G.	—	—	—	—
	Condensate Lift Mechanism	Max Distance	In. [mm]	—	—	—	—
		H	In. [mm]	23-5/8 [600]	23-5/8 [600]	23-5/8 [600]	23-5/8 [600]
	Dimensions	W	In. [mm]	29-17/32 [750]	29-17/32 [750]	29-17/32 [750]	29-17/32 [750]
D		In. [mm]	8-15/32 [215]	8-15/32 [215]	8-15/32 [215]	8-15/32 [215]	
Weight		lbs [kg]	33 [15.0]	33 [15.0]	33 [15.0]	33 [15.0]	
Outdoor Unit	MCA	A		11.0	11.0	16.0	16.0
	MOCP	A		15	15	20	20
	Dimensions	H	In. [mm]	21-5/8 [550]	21-5/8 [550]	21-5/8 [880]	21-5/8 [880]
		W	In. [mm]	31-1/2 [800]	31-1/2 [800]	31-1/2 [840]	31-1/2 [840]
		D	In. [mm]	11-1/4 [285]	11-1/4 [285]	11-1/4 [330]	11-1/4 [330]
	Weight	lbs [kg]		83 [38]	83 [38]	124 [56]	124 [56]
	Air Flow Rate (Cooling/Heating)	CFM		1074/1202	1074/1202	1653/1730	1653/1730
	Sound Pressure Level	Cooling	dB(A)	48	48	51	51
Heating		dB(A)	50	50	55	55	
Piping	Diameter	Gas (O.D.)	In. [mm]	3/8 [9.52]	3/8 [9.52]	1/2 [12.7]	1/2 [12.7]
		Liquid (O.D)	In. [mm]	1/4 [6.35]	1/4 [6.35]	1/4 [6.35]	1/4 [6.35]
		Indoor Drain	In. [mm]	19/32 O.D [15]	19/32 O.D [15]	19/32 O.D [15]	19/32 O.D [15]
	Max. Length	ft [m]		65 [20]	65 [20]	100 [30]	100 [30]
Max. Height	ft [m]		40 [12]	40 [12]	50 [15]	50 [15]	
Electrical	Outdoor-Indoor <sup>5</sup>	V, ph, Hz		208/230, 1, 60	208/230, 1, 60	208/230, 1, 60	208/230, 1, 60
	Recommended Breaker Size	A		15	15	20	20
Refrigerant Type				R410A	R410A	R410A	R410A
Guaranteed Temperature Operation Range	Cooling <sup>5</sup>	°F DB [°C DB]		14.0 to 115.0 [-10.0 to 46.0]	14.0 to 115.0 [-10.0 to 46.0]	14.0 to 115.0 [-10.0 to 46.0]	14.0 to 115.0 [-10.0 to 46.0]
	Heating	°F DB [°C DB]		-13.0 to 75.0 [-25.0 to 24.0]	-13.0 to 75.0 [-25.0 to 24.0]	-13.0 to 75.0 [-25.0 to 24.0]	-13.0 to 75.0 [-25.0 to 24.0]

**Notes:**

- AHRI Rated Conditions <sup>1</sup>Cooling (Indoor // Outdoor) °F 80 DB, 67 WB // 95 DB, 75 WB
- (Rated data is determined at a fixed compressor speed) <sup>2</sup>Heating at 47°F (Indoor // Outdoor) °F 70 DB, 60 WB // 47 DB, 43 WB
- <sup>3</sup>Heating at 17°F (Indoor // Outdoor) °F 70 DB, 60 WB // 17 DB, 15 WB
- Conditions <sup>4</sup>Heating at 5°F (Indoor // Outdoor) °F 70 DB, 60 WB // 5 DB, 4 WB

<sup>5</sup>Indoor units receive power from outdoor units through field-supplied interconnected wiring.

<sup>6</sup>Applications should be restricted to comfort cooling only; equipment cooling applications are not recommended for low ambient temperature conditions.

# Konnect Series

Konnect Series heat pump and Pro-Heat outdoor units achieve high energy-saving performance as well as heating capacity and all the combinations are ENERGY STAR® qualified. For an attractive and optimum use of indoor space, you can choose the indoor unit that best matches your needs.



NTXSKH(09/12/15/18)A112A\*

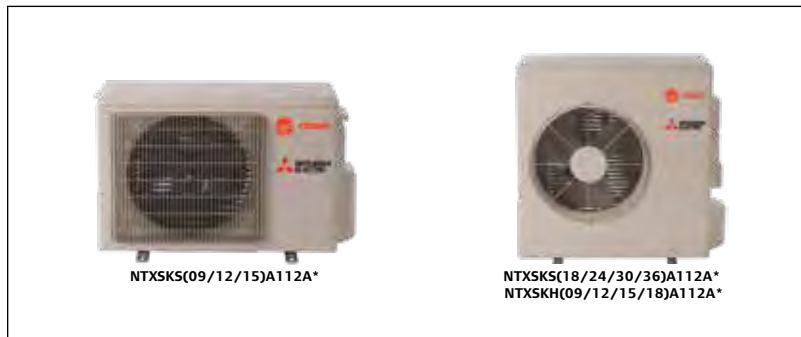

NTXSKS(09/12/15)A112A\*

NTXSKS(18/24/30/36)A112A\*  
NTXSKH(09/12/15/18)A112A\*



UKS



CKS



DKS



PEAD

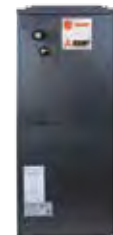

AMT

- Available capacities in KBTU/H: 9, 12, 15, 18, 24, 30, 36
- Single-zone outdoor unit matches multiple indoor unit options
- Heat Pump or Pro-Heat INVERTER

## Konnect Series Compatibility

Outdoor Unit Capacity KBTU/H		9		12		15		18		24		30		36	
Model	Type	HP	Pro-Heat	HP	Pro-Heat	HP	Pro-Heat	HP	Pro-Heat	HP	Pro-Heat	HP	Pro-Heat	HP	Pro-Heat
CKS	2' x 2' cassette	•	•	•	•	•	•	•	•						
DKS	Low static ducted	•	•	•	•	•	•	•	•						
PEAD	Mid static ducted	•	•	•	•	•	•	•	•	•		•		•	
AMT	Multi-position Air Handler			•	•			•	•	•		•		•	
UKS	EZ FIT™ Recessed Ceiling Cassette	•	•	•	•			•	•						

HP: Heat Pump

Pro-Heat: Pro-Heat Hyper-Heating



The Pro-Heat models provide heating even when it's -13° F (-25° C) outdoor ambient, producing up to 100% heating capacity at 5° F (-15° C). These units offer year-round comfort even in extreme climates.

**Operation guaranteed at -13° F,  
100% heating capacity at 5° F**

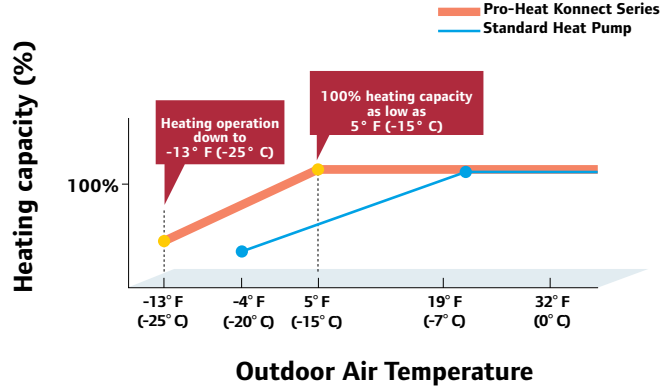

**Heating Performance at Low Temperatures**

NTXSKH09A112A*					NTXSKH12A112A*					
COP at	CKS	DKS	PEAD	UKS	COP at	CKS	DKS	PEAD	AMT	UKS
47° F	3.90	2.80	3.80	4.10	47° F	3.40	3.90	3.90	3.80	3.80
17° F	2.56	2.20	2.56	2.76	17° F	2.38	2.56	2.72	2.61	2.54
5° F	1.34	1.59	1.67	1.67	5° F	1.83	2.19	2.09	1.69	1.57

  

NTXSKH15A112A*				NTXSKH18A112A*					
COP at	CKS	DKS	PEAD	COP at	CKS	DKS	PEAD	AMT	UKS
47° F	2.60	2.70	3.00	47° F	2.70	3.40	3.30	3.30	3.00
17° F	1.91	2.15	2.29	17° F	2.20	2.52	2.49	2.32	2.42
5° F	1.84	1.88	1.81	5° F	1.44	1.75	1.66	1.75	1.39

**Built-in Base Heater**

The base heater restricts lowered capacity and operation shutdowns caused by the drain water freezing. This supports stable operation in low-temperature environments.

**Operation Guaranteed at  
Outside Temperature of -13° F (-25° C)**

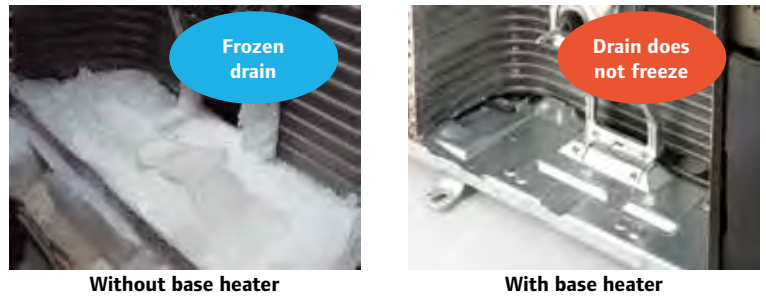

**Compact and Powerful Compressor**

A special manufacturing technology, Heat Caulking Fixing Method, has been introduced to reduce compressor size while maintaining a high compressor output. This technology enables the installation of a powerful compressor in compact outdoor units. As a result, excellent heating performance is achieved when operating in cold outdoor environments.

**Compressor using conventional method  
(Arc spot-welded method)**

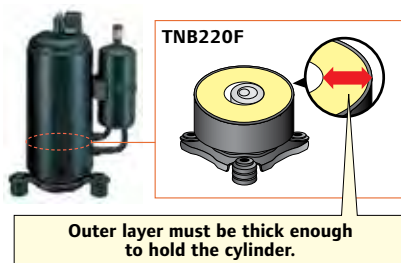

**Compressor using Heat Caulking Fixing Method**

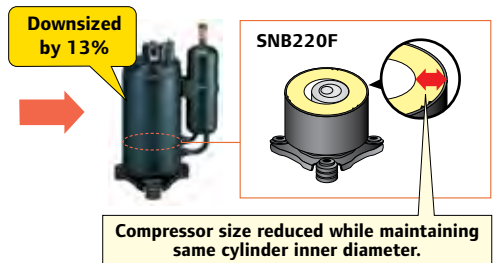

# UKS Model

Introducing EZ FIT™ ceiling cassette with streamlined interior dimensions and a sharp, sleek appearance.

NTXUKS(09/15/18)A112A\*



## Slim Design

Industry leading slim body realized a simple design with linear beauty.



## Ceiling Mounted

Installing the ceiling-mounted EZ FIT Model unit in a room creates a more spacious feel that enhances room comfort. This overhead format is also an excellent solution when lighting equipment is installed at the center of the room and fixtures such as bookshelves are mounted on wall surfaces.

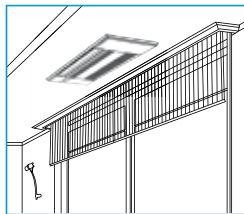

## Slim Body

The new units are designed with a slim body (only 7-5/16"), ensuring easy installation even when low ceiling cavities limit installation space. The need for ceiling cavity service space is also eliminated, further reducing the dimensions required for installation.



## Set Airflow According to Ceiling Height

Dual-level airflow selection is engineered to accommodate specific ceiling heights. This is a key feature for adjusting airflow effectively when it is either too strong or too weak due to being mismatched with the height of the ceiling.

	09	12	18
Standard	7-7/8 ft.	7-7/8 ft.	7-7/8 ft.
High ceiling	8-7/8 ft.	8-7/8 ft.	8-7/8 ft.



## Auto Vane Control

Outlet vanes can be moved left and right, and up and down using the remote controller. This improved airflow control feature solves the problem of drafts.

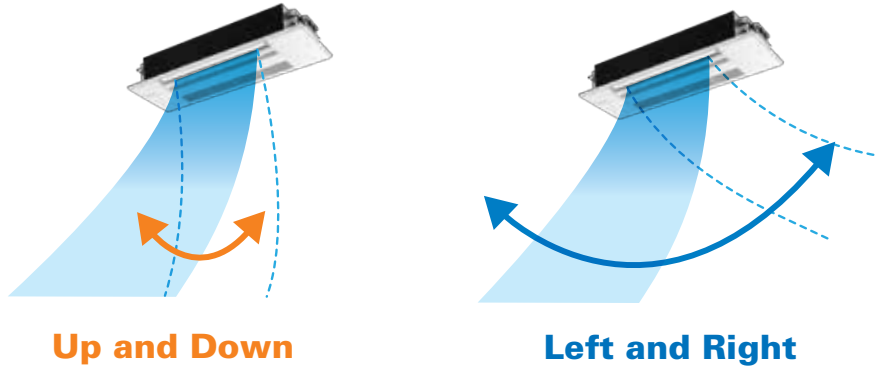

\*Only available when Econo Cool is set.

## Weekly Timer Built-in Weekly Timer Function

Easily set desired temperatures and operation ON/OFF times to match lifestyle patterns. Reduce wasted energy consumption by using the timer to prevent forgetting to turn off the unit and eliminate temperature setting adjustments.

### Example Operation Pattern (Winter/Heating mode)

	Mon.	Tues.	Wed.	Thurs.	Fri.	Sat.	Sun.
6:00 AM	ON 68°F	ON 68°F	ON 68°F	ON 68°F	ON 68°F	ON 68°F	ON 68°F
8:00 AM	Automatically changes to high-power operation at wake-up time						
10:00 AM	OFF	OFF	OFF	OFF	OFF	ON 64°F	ON 64°F
12:00 AM	Automatically turned off during work hours					Midday is warmer, so the temperature is set lower	
2:00 PM							
4:00 PM							
6:00 PM	ON 72°F	ON 72°F	ON 72°F	ON 72°F	ON 72°F	ON 72°F	ON 72°F
8:00 PM	Automatically turns on, synchronized with arrival at home					Automatically raises temperature setting to match time when outside-air temperature is low	
10:00 PM							
(during sleeping hours)	ON 64°F	ON 64°F	ON 64°F	ON 64°F	ON 64°F	ON 64°F	ON 64°F
	Automatically lowers temperature at bedtime for energy-saving operation at night						

**Settings** **Pattern Settings:** Input up to four settings for each day  
**Settings:** • Start/Stop operation • Temperature setting \*The operation mode cannot be set.

### Easy set-up using dedicated buttons



The remote controller is equipped with buttons that are used exclusively for setting the Weekly Timer. Setting operation patterns is easy and quick.

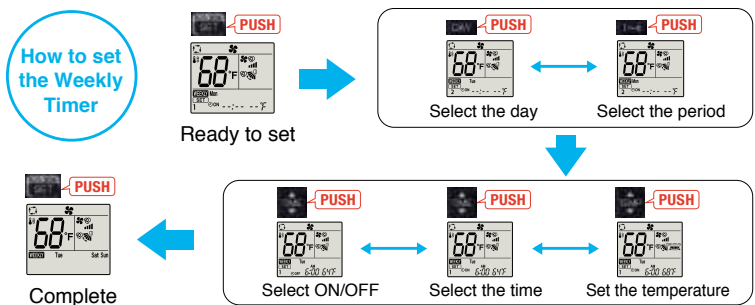

- Start by pushing the SET button and follow the instructions to set the desired patterns. Once all of the desired patterns are input, point the top end of the remote controller at the indoor unit and push the SET button one more time. (Push the SET button only after inputting all of the desired patterns into the remote controller memory. Pushing the CANCEL button will end the set-up process without sending the operation patterns to the indoor unit).
- It takes a few seconds to transmit the Weekly Timer operation patterns to the indoor unit. Please continue to point the remote controller at the indoor unit until all data has been sent.

# Easy Installation

## Industry Leading Slim Body

The EZ FIT™ can be installed within standard joists that span 16 inches on center. There is no need for large-scale construction, such as the cutting of the joist.



## Temporary hanging hook

Work efficiency has improved during installation.

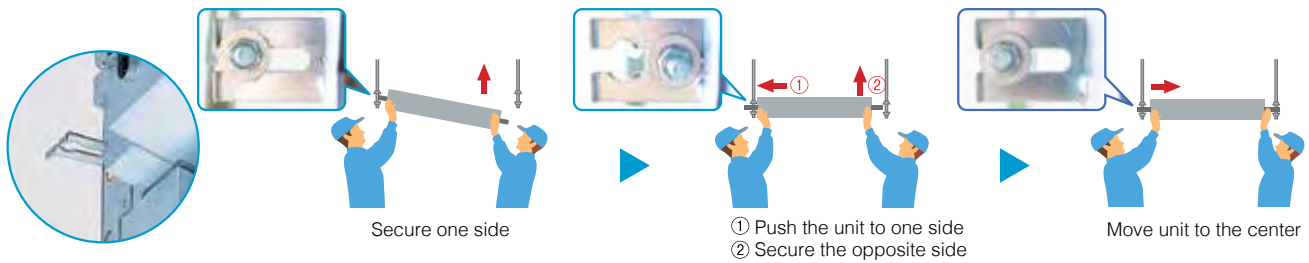

## Drain Piping Supporters + Drain Cover

Industry leading slim body realized a simple design with linear beauty.

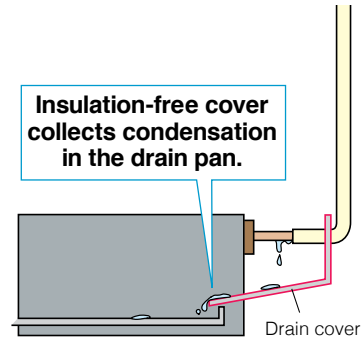
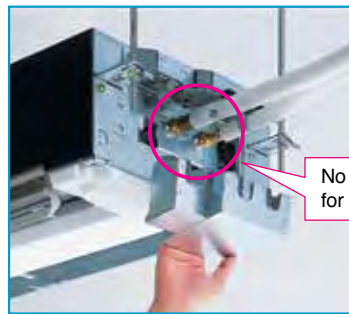
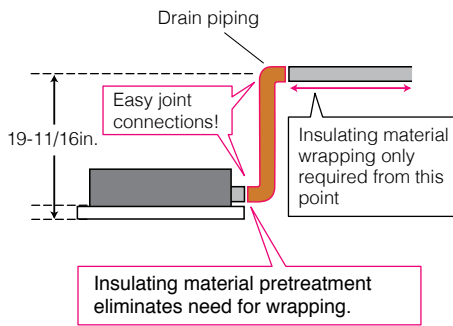

## Wireless Interface Installation

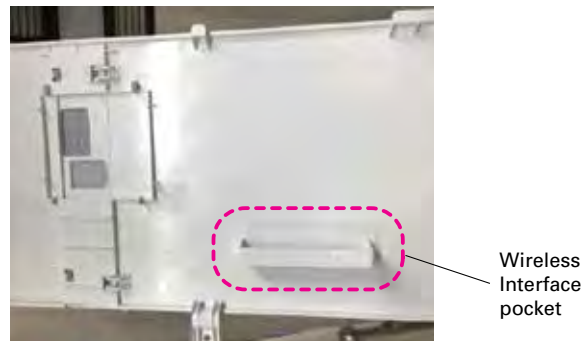

(Optional)

The indoor unit panel is equipped with a Wireless Interface pocket, contributing to the beautiful appearance, easy installation and maintenance.



# UKS Model



<b>Indoor Unit</b> NTXUKS(09/15/18)A112A* 	<b>Outdoor Unit</b> NTXSKS09/12A112A* 	<b>Remote Controller</b> 
<b>Panel</b> TLP-444W *Requires TLP-444W grille		
		

Indoor Unit				NTXUKS09A112A*	NTXUKS12A112A*	NTXUKS18A112A*
Outdoor Unit				NTXSKS09A112A*	NTXSKS12A112A*	NTXSKS18A112A*
Cooling	Capacity	Rated <sup>1</sup>	BTU/H	9,000	12,000	18,000
	Capacity Range	Min-Max	BTU/H	3,600-9,000	3,900-12,000	6,600-18,000
	Power Input	Rated <sup>1</sup>	W	710	960	1,440
	Moisture Removal	Pints/h		1.5	2.8	5.3
	Sensible Heat Factor			0.820	0.740	0.670
Heating	Capacity at 47°F	Rated <sup>2</sup>	BTU/H	12,000	15,400	20,000
	Capacity Range	Min-Max	BTU/H	4,010-13,000	4,600-17,000	8,200-22,800
	Power Input at 47°F	Rated <sup>2</sup>	W	860	1,300	1,170
	Capacity at 17°F	Rated <sup>3</sup>	BTU/H	7,700	9,900	13,100
		Max	BTU/H	7,700	9,900	13,100
Efficiency	SEER			19.5	19.8	22.3
	EER			12.6	12.5	12.5
	HSPF			13.3	12.1	12.4
	COP			4.0	3.4	3.3
	ENERGY STAR® Certified			Yes	Yes	Yes
Indoor Unit	Air Flow Rate - Cooling (Quiet-Lo-Med-Hi-SHi)	Dry	CFM	212-254-283-311	212-258-297-332	212-293-346-403
		Wet	CFM	180-216-240-264	180-219-252-282	180-249-294-343
	Air Flow Rate - Heating (Quiet-Lo-Med-Hi-SHi)	Dry	CFM	212-247-290-325	212-272-311-350	212-311-364-417
		Sound Pressure Level (Quiet-Lo-Med-Hi-SHi)	Cooling	dB(A)	27-31-34-38	27-32-36-40
		Heating	dB(A)	26-29-34-37	26-32-36-40	26-37-42-48
	External Static Pressure		In. W.G.	—	—	—
	Condensate Lift Mechanism	Max Distance	In. [mm]	19-11/16 [500]	19-11/16 [500]	19-11/16 [500]
		H	In. [mm]	7-5/16 [185]	7-5/16 [185]	7-5/16 [185]
	Dimensions	W	In. [mm]	43-3/8 [1102]	43-3/8 [1102]	43-3/8 [1102]
		D	In. [mm]	14-3/16 [360]	14-3/16 [360]	14-3/16 [360]
Weight		lbs [kg]	34 [15.5]	34 [15.5]	34 [15.5]	
Outdoor Unit	MCA	A		9.0	9.0	14.0
	MOCP	A		15	16	24
	Dimensions	H	In. [mm]	21-5/8 [550]	21-5/8 [550]	34-5/8 [880]
		W	In. [mm]	31-1/2 [800]	31-1/2 [800]	33-1/16 [840]
		D	In. [mm]	11-1/4 [285]	11-1/4 [285]	13 [330]
	Weight	lbs [kg]		81 [37]	81 [37]	127 [58]
	Air Flow Rate (Cooling/Heating)		CFM	1228/1172	1228/1172	1691/1691
	Sound Pressure Level	Cooling	dB(A)	48	49	54
		Heating	dB(A)	50	51	55
	Piping	Diameter	Gas (O.D.)	In. [mm]	3/8 [9.52]	3/8 [9.52]
Liquid (O.D.)			In. [mm]	1/4 [6.35]	1/4 [6.35]	1/4 [6.35]
Indoor Drain			In. [mm]	1-1/4 [32]	1-1/4 [32]	1-1/4 [32]
Max. Length		ft [m]		65 [20]	65 [20]	100 [30]
Max. Height	ft [m]		40 [12]	40 [12]	50 [15]	
Electrical	Outdoor-Indoor <sup>5</sup>	V, ph, Hz		208/230, 1, 60	208/230, 1, 60	208/230, 1, 60
	Recommended Breaker Size	A		15	15	15
Refrigerant Type				R410A	R410A	R410A
Guaranteed Temperature Operation Range	Cooling <sup>6</sup>	°F DB [°C DB]		14.0 to 115.0 [-10.0 to 46.0]	14.0 to 115.0 [-10.0 to 46.0]	14.0 to 115.0 [-10.0 to 46.0]
	Heating	°F DB [°C DB]		-4.0 to -75.0 [-20.0 to 24.0]	-4.0 to -75.0 [-20.0 to 24.0]	-4.0 to -75.0 [-20.0 to 24.0]

**Notes:**

AHRI Rated Conditions  
(Rated data is determined at a fixed compressor speed)

<sup>1</sup>Cooling (Indoor // Outdoor)

<sup>2</sup>Heating at 47°F (Indoor // Outdoor)

<sup>3</sup>Heating at 17°F (Indoor // Outdoor)

<sup>4</sup>Heating at 5°F (Indoor // Outdoor)

<sup>5</sup>Indoor units receive power from outdoor units through field-supplied interconnected wiring.

<sup>6</sup>Applications should be restricted to comfort cooling only; equipment cooling applications are not recommended for low ambient temperature conditions.

°F 80 DB, 67 WB // 95 DB, 75 WB

°F 70 DB, 60 WB // 47 DB, 43 WB

°F 70 DB, 60 WB // 17 DB, 15 WB

°F 70 DB, 60 WB // 5 DB, 4 WB

# UKS Model



**Indoor Unit**

NTXUKS(09/15/18)A112A\*



**Outdoor Unit**



NTXSKH(09/12/18)A112A\*

**Remote Controller**



**Panel** TLP-444W \*Requires TLP-444W grille

Econo Cool

Air Purifying

Anti-allergy Enzyme

AUTO VANE

SWING

AUTO

Weekly Timer

ACO

Auto Restart

Group Control

M-NET connection

Wi-Fi Interface

MX connection

10°C

Sleep

Drain Lift Up

Flare connection

Self Diagnosis

Failure Recall

Hi

Indoor Unit				NTXUKS09A112A*	NTXUKS12A112A*	NTXUKS18A112A*
Outdoor Unit				NTXSKH09A112A*	NTXSKH12A112A*	NTXSKH18A112A*
Cooling	Capacity	Rated <sup>1</sup>	BTU/H	9,000	12,000	16,700
	Capacity Range	Min-Max	BTU/H	4,800-9,000	5,270-12,000	8,740-16,700
	Power Input	Rated <sup>1</sup>	W	720	940	1,335
	Moisture Removal	Pints/h		1.8	3.1	5.1
	Sensible Heat Factor			0.780	0.710	0.660
Heating	Capacity at 47°F	Rated <sup>2</sup>	BTU/H	12,000	15,000	18,600
	Capacity Range	Min-Max	BTU/H	8,300-14,000	7,800-18,000	8,500-22,000
	Power Input at 47°F	Rated <sup>2</sup>	W	840	1,130	1,780
	Capacity at 17°F	Rated <sup>3</sup>	BTU/H	6,600	9,100	11,800
		Max	BTU/H	12,000	15,000	18,600
	Capacity at 5°F	Max <sup>4</sup>	BTU/H	12,000	15,000	18,600
Efficiency	SEER			18.9	19.0	18.8
	EER			12.5	12.7	12.5
	HSPF			11	10.2	10
	COP			4.1	3.8	3.0
	ENERGY STAR® Certified			Yes	Yes	Yes
Indoor Unit	Air Flow Rate - Cooling (Quiet-Lo-Med-Hi-SHi)	Dry	CFM	212-254-283-311	212-258-297-332	212-293-346-403
		Wet	CFM	180-216-240-264	180-219-252-282	180-249-294-343
	Air Flow Rate - Heating (Quiet-Lo-Med-Hi-SHi)	Dry	CFM	212-247-290-325	212-272-311-350	212-311-364-417
		Cooling	dB(A)	27-31-34-38	27-32-36-40	29-36-41-47
		Heating	dB(A)	26-29-34-37	26-32-36-40	26-37-42-48
	External Static Pressure		In. W.G.	—	—	—
	Condensate Lift Mechanism	Max Distance	In. [mm]	19-11/16 [500]	19-11/16 [500]	19-11/16 [500]
		H	In. [mm]	7-5/16 [185]	7-5/16 [185]	7-5/16 [185]
	Dimensions	W	In. [mm]	43-3/8 [1102]	43-3/8 [1102]	43-3/8 [1102]
		D	In. [mm]	14-3/16 [360]	14-3/16 [360]	14-3/16 [360]
Weight		lbs [kg]	34 [15.5]	34 [15.5]	34 [15.5]	
Outdoor Unit	MCA	A		14.0	14.0	17.0
	MOCP	A		24	24	31
	Dimensions	H	In. [mm]	34-5/8 [880]	34-5/8 [880]	34-5/8 [880]
		W	In. [mm]	38-1/16 [840]	33-1/16 [840]	33-1/16 [840]
		D	In. [mm]	13 [330]	13 [330]	13 [330]
	Weight	lbs [kg]		129 [58.5]	129 [58.5]	131 [59.5]
	Air Flow Rate (Cooling/Heating)	CFM		1,691/1,691	1,691/1,691	2,020/1,930
	Sound Pressure Level	Cooling	dB(A)	54	54	55
		Heating	dB(A)	55	55	55
	Piping	Diameter	Gas (O.D.)	In. [mm]	3/8 [9.52]	3/8 [9.52]
Liquid (O.D.)			In. [mm]	1/4 [6.35]	1/4 [6.35]	1/4 [6.35]
Indoor Drain			In. [mm]	1-1/4 [32]	1-1/4 [32]	1-1/4 [32]
Max. Length		ft [m]		65 [20]	65 [20]	100 [30]
Max. Height	ft [m]		40 [12]	40 [12]	50 [15]	
Electrical	Outdoor-Indoor <sup>5</sup>	V, ph, Hz		208/230, 1, 60	208/230, 1, 60	208/230, 1, 60
	Recommended Breaker Size	A		15	15	20
Refrigerant Type				R410A	R410A	R410A
Guaranteed Temperature Operation Range	Cooling <sup>6</sup>	°F DB [°C DB]		14.0 to 115.0 [-10.0 to 46.0]	14.0 to 115.0 [-10.0 to 46.0]	14.0 to 115.0 [-10.0 to 46.0]
	Heating	°F DB [°C DB]		-13.0 to -75.0 [-25.0 to 24.0]	-13.0 to -75.0 [-25.0 to 24.0]	-13.0 to -75.0 [-25.0 to 24.0]

**Notes:**

- AHRI Rated Conditions (Rated data is determined at a fixed compressor speed)
  - <sup>1</sup>Cooling (Indoor // Outdoor) °F 80 DB, 67 WB // 95 DB, 75 WB
  - <sup>2</sup>Heating at 47°F (Indoor // Outdoor) °F 70 DB, 60 WB // 47 DB, 43 WB
  - <sup>3</sup>Heating at 17°F (Indoor // Outdoor) °F 70 DB, 60 WB // 17 DB, 15 WB
  - <sup>4</sup>Heating at 5°F (Indoor // Outdoor) °F 70 DB, 60 WB // 5 DB, 4 WB
- Conditions
- <sup>5</sup>Indoor units receive power from outdoor units through field-supplied interconnected wiring.
- <sup>6</sup>Applications should be restricted to comfort cooling only; equipment cooling applications are not recommended for low ambient temperature conditions.

# AMT Model

The multi-position air handler is well-suited for supplemental or replacement applications, and allows for effective and efficient air conditioning as airflow strength can be set to ensure any desired comfort level.

NTXAMT(12/18/24/30/36)A112A\*

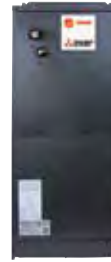

## Slim Design

Industry leading quality and compact design.

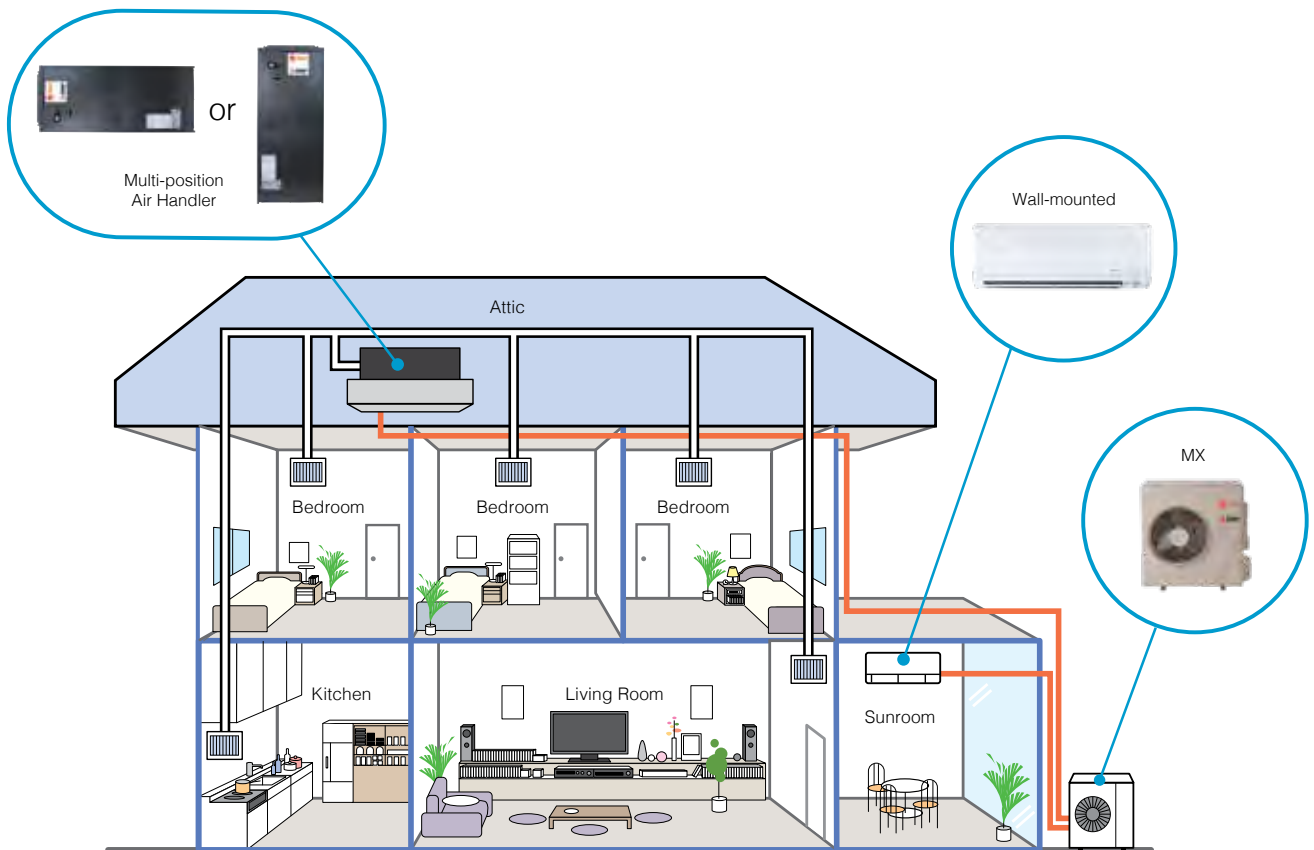

## Flexibility

The AMT air handler is truly multi-positional unit offering up, down\*, left or right airflow, making it ideal for tight and unique spaces.

\*Downflow kit required for downflow installations

## Quiet

The DC motor ensures quiet and efficient operation year round.

## Small Footprint

The AMT's compact design makes it possible to replace any kind of existing furnace or air handler, and can also be hidden in a closet or basement corner. The single-zone and multi-zone outdoor units are compact as well, since up to eight indoor units can be connected to one outdoor unit.

# AMT Model

**Indoor Unit**



NTXAMT(12/18/24/30/36)  
A112A\*

**Outdoor Unit**



NTXSKS(18/24/30/36)  
A112A\*



NTXSKS12A112A\*

\* To confirm compatibility with the MX Model multi-zone system, refer to MX Model page.

Air Filter

ACO

Auto Restart

Optional

Group Control

M-NET connection

Optional

USNAP

Optional

Optional

T-STAT

Optional



MX connection

Indoor Unit				NTXAMT12A112A*	NTXAMT18A112A*	NTXAMT24A112A*	NTXAMT30A112A*	NTXAMT36A112A*
Outdoor Unit				NTXSKS12A112A*	NTXSKS18A112A*	NTXSKS24A112A*	NTXSKS30A112A*	NTXSKS36A112A*
Cooling	Capacity	Rated <sup>1</sup>	BTU/H	12,000	18,000	24,000	27,000	33,000
	Capacity Range	Min-Max	BTU/H	4,300–12,000	6,200–18,000	12,400–24,000	13,500–27,000	11,600–33,000
	Power Input	Rated <sup>1</sup>	W	940	1,360	1,920	2,160	3,720
	Moisture Removal	Pints/h		1.2	2.4	4.1	2.4	4.7
	Sensible Heat Factor			0.890	0.850	0.810	0.900	0.840
Heating	Capacity at 47°F	Rated <sup>2</sup>	BTU/H	15,000	21,600	25,000	30,000	33,500
	Capacity Range	Min-Max	BTU/H	4,700–16,700	8,300–26,000	14,600–28,000	12,640–33,000	13,260–36,000
	Power Input at 47°F	Rated <sup>2</sup>	W	1,210	1,600	1,910	2,060	3,030
	Capacity at 17°F	Rated <sup>3</sup>	BTU/H	9,900	14,000	14,600	21,400	23,200
	Capacity at 5°F	Max <sup>4</sup>	BTU/H	9,900	14,000	14,600	21,400	23,200
Efficiency	SEER			18.0	18.0	18.0	18.0	16.0
	EER			12.7	13.2	12.5	12.5	8.8
	HSPF			12.10	12.60	10.40	13.60	11.70
	COP			3.6	3.9	3.8	4.2	3.2
	ENERGY STAR® Certified			Yes	Yes	Yes	Yes	No
Indoor Unit	Air Flow Rate - Cooling (Quiet-Lo-Med-Hi-SHi)	Dry	CFM	278–381–448	471–573–675	515–625–735	613–744–875	767–910–910
		Wet	CFM	—	—	—	—	—
	Air Flow Rate - Heating (Quiet-Lo-Med-Hi-SHi)	Dry	CFM	278–381–448	471–573–675	515–625–735	613–744–875	767–910–910
		Sound Pressure Level (Quiet-Lo-Med-Hi-SHi)	Cooling	dB(A)	29–36–39	33–36–41	30–34–38	32–46–40
		Heating	dB(A)	29–36–39	33–36–41	30–34–38	32–46–40	35–39–43
	External Static Pressure	In. W.G.		0.3–0.5–0.8	0.3–0.5–0.8	0.3–0.5–0.8	0.3–0.5–0.8	0.3–0.5–0.8
	Condensate Lift Mechanism	Max Distance	In. [mm]	—	—	—	—	—
		H	In. [mm]	39-13/16 [1011]	39-13/16 [1011]	39-13/16 [1011]	43-3/4 [1111]	43-3/4 [1111]
	Dimensions	W	In. [mm]	17 [432]	17 [432]	17 [432]	21 [533]	21 [533]
		D	In. [mm]	21-5/8 [548]	21-5/8 [548]	21-5/8 [549]	21-5/8 [549]	21-5/8 [549]
Weight	lbs [kg]		93 [42]	93 [42]	93 [42]	119 [54]	119 [54]	
MCA	A		9.0	14.0	17.0	17.0	17.0	
MOCP	A		16	24	31	31	31	
Outdoor Unit	Dimensions	H	In. [mm]	21-5/8 [550]	34-5/8 [880]	34-5/8 [880]	34-5/8 [880]	34-5/8 [880]
		W	In. [mm]	31-1/2 [800]	33-1/16 [840]	33-1/16 [840]	33-1/16 [840]	33-1/16 [840]
	D	In. [mm]	11-1/4 [285]	13 [330]	13 [330]	13 [330]	13 [330]	
	Weight	lbs [kg]		81 [37]	127 [58]	129 [58.5]	129 [58.5]	129 [58.5]
Air Flow Rate (Cooling/Heating)	CFM		1228/1172	1691/1691	2020/1930	2020/1930	2020/1930	
Sound Pressure Level	Cooling	dB(A)	49	54	55	55	55	
	Heating	dB(A)	51	55	55	55	55	
Piping	Diameter	Gas (O.D.)	In. [mm]	3/8 [9.52]	1/2 [12.7]	5/8 [15.88]	5/8 [15.88]	5/8 [15.88]
		Liquid (O.D.)	In. [mm]	1/4 [6.35]	1/4 [6.35]	3/8 [9.52]	3/8 [9.52]	3/8 [9.52]
		Indoor Drain	In. [mm]	3/4 [19.05]	3/4 [19.05]	3/4 [19.05]	3/4 [19.05]	3/4 [19.05]
	Max. Length	ft [m]		65 [20]	100 [30]	100 [30]	100 [30]	100 [30]
Max. Height	ft [m]		40 [12]	50 [15]	100 [30]	100 [30]	100 [30]	
Electrical	Outdoor-Indoor <sup>5</sup>	V, ph, Hz		208/230, 1, 60	208/230, 1, 60	208/230, 1, 60	208/230, 1, 60	208/230, 1, 60
	Recommended Breaker Size	A		15	15	20	20	20
Refrigerant Type				R410A	R410A	R410A	R410A	R410A
Guaranteed Temperature Operation Range	Cooling <sup>6</sup>	°F DB [°C DB]		14.0 to 115.0 [-10.0 to 46.0]	14.0 to 115.0 [-10.0 to 46.0]	14.0 to 115.0 [-10.0 to 46.0]	14.0 to 115.0 [-10.0 to 46.0]	14.0 to 115.0 [-10.0 to 46.0]
	Heating	°F DB [°C DB]		-4.0 to -75.0 [-20.0 to 24.0]	-4.0 to -75.0 [-20.0 to 24.0]	-4.0 to -75.0 [-10.0 to 24.0]	-4.0 to -75.0 [-10.0 to 24.0]	-4.0 to -75.0 [-10.0 to 24.0]

Notes:  
 AHRI Rated Conditions (Rated data is determined at a fixed compressor speed)  
 Conditions  
<sup>1</sup>Cooling (Indoor // Outdoor) °F 80 DB, 67 WB // 95 DB, 75 WB  
<sup>2</sup>Heating at 47°F (Indoor // Outdoor) °F 70 DB, 60 WB // 47 DB, 43 WB  
<sup>3</sup>Heating at 17°F (Indoor // Outdoor) °F 70 DB, 60 WB // 17 DB, 15 WB  
<sup>4</sup>Heating at 5°F (Indoor // Outdoor) °F 70 DB, 60 WB // 5 DB, 4 WB  
<sup>5</sup>Indoor units receive power from outdoor units through field-supplied interconnected wiring.  
<sup>6</sup>Applications should be restricted to comfort cooling only; equipment cooling applications are not recommended for low ambient temperature conditions.



# AMT Model

<b>Indoor Unit</b>  NTXAMT12/18A112A*  	<b>Outdoor Unit</b>  NTXSKH(12/18)A112A*  
* To confirm compatibility with the MX Model multi-zone system, refer to MX Model page.	
<div style="display: flex; justify-content: space-around; align-items: center;"> <div style="border: 1px solid black; padding: 2px; font-size: 8px;">Air Filter</div> <div style="border: 1px solid black; padding: 2px; font-size: 8px;">ACO</div> <div style="border: 1px solid black; padding: 2px; font-size: 8px;">Auto Restart</div> <div style="border: 1px solid black; padding: 2px; font-size: 8px;">Optional</div> <div style="border: 1px solid black; padding: 2px; font-size: 8px;">Group Control</div> <div style="border: 1px solid black; padding: 2px; font-size: 8px;">M-NET connection</div> <div style="border: 1px solid black; padding: 2px; font-size: 8px;">Optional</div> <div style="border: 1px solid black; padding: 2px; font-size: 8px;">USNAP</div> <div style="border: 1px solid black; padding: 2px; font-size: 8px;">Optional</div> <div style="border: 1px solid black; padding: 2px; font-size: 8px;">WiFi</div> <div style="border: 1px solid black; padding: 2px; font-size: 8px;">Optional</div> <div style="border: 1px solid black; padding: 2px; font-size: 8px;">T-STAT</div> <div style="border: 1px solid black; padding: 2px; font-size: 8px;">Optional</div> <div style="border: 1px solid black; padding: 2px; font-size: 8px;">MX connection</div> <div style="border: 1px solid black; padding: 2px; font-size: 8px;">Pro-Heat</div> </div>	

Indoor Unit				NTXAMT12A112A*	NTXAMT18A112A*
Outdoor Unit				NTXSKH12A112A*	NTXSKH18A112A*
Cooling	Capacity	Rated <sup>1</sup>	BTU/H	12,000	18,000
	Capacity Range	Min-Max	BTU/H	5,600–12,000	9,360–18,000
	Power Input	Rated <sup>1</sup>	W	860	1,440
	Moisture Removal	Pints/h		0.8	1.1
	Sensible Heat Factor			0.920	0.930
Heating	Capacity at 47°F	Rated <sup>2</sup>	BTU/H	15,000	21,600
	Capacity Range	Min-Max	BTU/H	7,700–18,000	8,800–28,000
	Power Input at 47°F	Rated <sup>2</sup>	W	1,130	1,880
	Capacity at 17°F	Rated <sup>3</sup>	BTU/H	8,900	14,300
		Max	BTU/H	15,000	21,600
	Capacity at 5°F	Max <sup>4</sup>	BTU/H	15,000	21,600
Efficiency	SEER			19.0	18.4
	EER			13.9	12.5
	HSPF			10.2	10.4
	COP			3.8	3.3
	ENERGY STAR® Certified			Yes	Yes
Indoor Unit	Air Flow Rate - Cooling (Quiet-Lo-Med-Hi-SHi)	Dry	CFM	278–381–448	471–573–675
		Wet	CFM	—	—
	Air Flow Rate - Heating (Quiet-Lo-Med-Hi-SHi)	Dry	CFM	278–381–448	471–573–675
		Sound Pressure Level (Quiet-Lo-Med-Hi-SHi)	Cooling	dB(A)	29–36–39
		Heating	dB(A)	29–36–39	33–36–41
	External Static Pressure		In. W.G.	0.3–0.5–0.8	0.3–0.5–0.8
	Condensate Lift Mechanism	Max Distance	In. [mm]	—	—
		H	In. [mm]	39-13/16 [1011]	39-13/16 [1011]
		W	In. [mm]	17 [432]	17 [432]
	Dimensions	D	In. [mm]	21-5/8 [548]	21-5/8 [548]
Weight		lbs [kg]	93 [42]	93 [42]	
Outdoor Unit	MCA	A		14.0	17.0
	MOCP	A		24	31
	Dimensions	H	In. [mm]	34-5/8 [880]	34-5/8 [880]
		W	In. [mm]	33-1/16 [840]	33-1/16 [840]
		D	In. [mm]	13 [330]	13 [330]
	Weight	lbs [kg]		129 [58.5]	131 [59.5]
	Air Flow Rate (Cooling/Heating)		CFM	1,691/1,691	2,020/1,930
	Sound Pressure Level	Cooling	dB(A)	54	55
		Heating	dB(A)	55	55
	Piping	Diameter	Gas (O.D.)	In. [mm]	3/8 [9.52]
Liquid (O.D.)			In. [mm]	1/4 [6.35]	1/4 [6.35]
Indoor Drain			In. [mm]	3/4 [19.05]	3/4 [19.05]
Max. Length		ft [m]		65 [20]	100 [30]
Max. Height		ft [m]		40 [12]	50 [15]
Electrical	Outdoor-Indoor <sup>5</sup>	V, ph, Hz		208/230, 1, 60	208/230, 1, 60
	Recommended Breaker Size	A		15	20
Refrigerant Type				R410A	R410A
Guaranteed Temperature Operation Range	Cooling <sup>6</sup>	°F DB [°C DB]		14.0 to 115.0 [-10.0 to 46.0]	14.0 to 115.0 [-10.0 to 46.0]
	Heating	°F DB [°C DB]		-13.0 to -75.0 [-25.0 to 24.0]	-13.0 to -75.0 [-25.0 to 24.0]

**Notes:**

AHRI Rated Conditions (Rated data is determined at a fixed compressor speed)

<sup>1</sup>Cooling (Indoor // Outdoor)

<sup>2</sup>Heating at 47°F (Indoor // Outdoor)

<sup>3</sup>Heating at 17°F (Indoor // Outdoor)

<sup>4</sup>Heating at 5°F (Indoor // Outdoor)

°F 80 DB, 67 WB // 95 DB, 75 WB

°F 70 DB, 60 WB // 47 DB, 43 WB

°F 70 DB, 60 WB // 17 DB, 15 WB

°F 70 DB, 60 WB // 5 DB, 4 WB

<sup>5</sup>Indoor units receive power from outdoor units through field-supplied interconnected wiring.

<sup>6</sup>Applications should be restricted to comfort cooling only; equipment cooling applications are not recommended for low ambient temperature conditions.

# CKS Model

Compact, lightweight ceiling cassette units with 4-way air outlets provide maximum comfort by evenly distributing airflow throughout the entire room.



## Flexibility

The attractive CKS Model ceiling cassette units offer a slim width and a 4-way air outlet. The size and shape are a perfect match for ceilings made using 2'x2' construction and its light weight package makes installation easy.

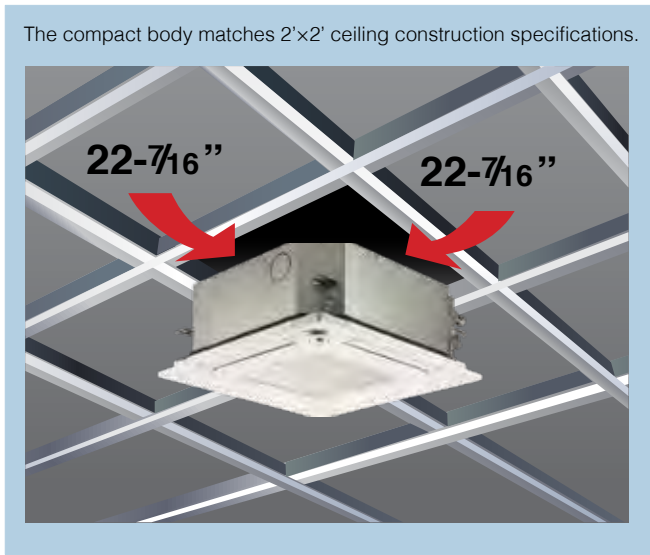

■ NTXCKS12A112A\*

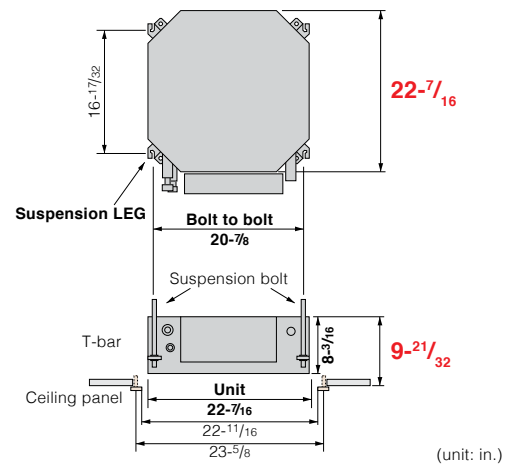

\* Access door is required

## Fresh-air Intake

A duct hole is provided in the main body, making it possible to intake fresh air from outside.

■ Intake-air volume

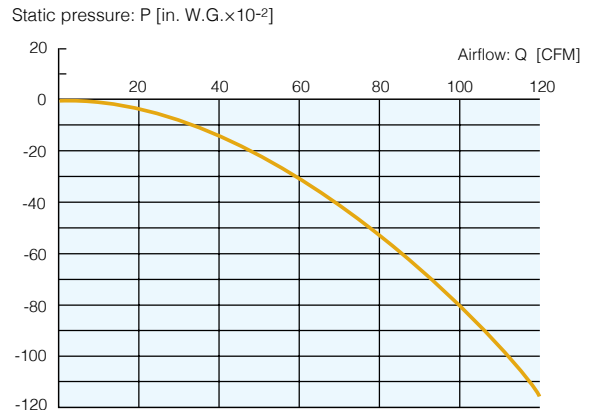

Note: Fresh-air intake amount should be 20% or less of whole air amount to prevent dew dripping. Booster fan required.

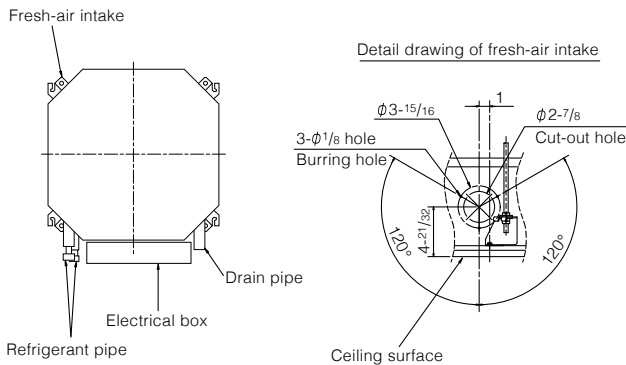

# CKS Model



<b>Indoor Unit</b>  NTXCKS(09/12/15/18)A112A*	<b>Outdoor Unit</b> NTXSKS(09/12/15)A112A*  NTXSKS18A112A*	<b>Remote Controller</b>  *optional TAC-YT53CRAU-J  *optional TAR-40MAAU  *optional TAR-CT01MAU-SB  *optional PAR-SL100A-E
Panel TLP-18FAU (standard grille) TLP-18FAEU (3D i-see Sensor grille)		

Indoor Unit				NTXCKS09A112A*	NTXCKS12A112A*	NTXCKS15A112A*	NTXCKS18A112A*
Outdoor Unit				NTXSKS09A112A*	NTXSKS12A112A*	NTXSKS15A112A*	NTXSKS18A112A*
Cooling	Capacity	Rated <sup>1</sup>	BTU/H	9,000	12,000	14,100	17,700
	Capacity Range	Min-Max	BTU/H	3,600-9,000	3,900-12,000	5,100-14,100	6,100-17,700
	Power Input	Rated <sup>1</sup>	W	670	900	1,150	1,410
	Moisture Removal	Pints/h		1.0	2.8	3.2	4.7
	Sensible Heat Factor			0.870	0.740	0.750	0.710
Heating	Capacity at 47°F	Rated <sup>2</sup>	BTU/H	11,000	13,000	18,000	19,700
	Capacity Range	Min-Max	BTU/H	4,010-12,000	4,800-13,000	5,100-19,100	8,400-20,900
	Power Input at 47°F	Rated <sup>2</sup>	W	4,010	4,800	5,100	8,400
	Capacity at 17°F	Rated <sup>3</sup>	BTU/H	6,900	8,900	11,900	12,900
		Max	BTU/H	6,900	8,900	11,900	12,900
Efficiency	Capacity at 5°F	Max <sup>4</sup>	BTU/H	5,600	6,100	8,900	9,800
	SEER			22.4	22.0	19.8	20.7
	EER			13.4	13.3	12.2	12.5
	HSPF			12.2	11.4	11.2	11.6
	COP			3.9	2.9	3.0	3.1
ENERGY STAR® Certified				Yes	Yes	No	Yes
Indoor Unit	Air Flow Rate - Cooling (Quiet-Lo-Med-Hi-SHi)	Dry	CFM	230-265-300	230-265-335	245-315-405	300-420-475
		Wet	CFM	207-239-270	207-252-302	221-284-365	270-378-429
	Air Flow Rate - Heating (Quiet-Lo-Med-Hi-SHi)	Dry	CFM	230-265-335	230-265-335	245-315-405	300-420-475
		Sound Pressure Level (Quiet-Lo-Med-Hi-SHi)	Cooling	dB(A)	25-28-31	25-30-34	27-34-39
		Heating	dB(A)	25-28-31	25-30-34	27-34-39	32-40-43
	External Static Pressure		In. W.G.	—	—	—	—
	Condensate Lift Mechanism	Max Distance	In. [mm]	33 [850]	33 [850]	33 [850]	33 [850]
		H	In. [mm]	9-21/32 [245]	9-21/32 [245]	9-21/32 [245]	9-21/32 [245]
	Dimensions	W	In. [mm]	22-7/16 [570]	22-7/16 [570]	22-7/16 [570]	22-7/16 [570]
		D	In. [mm]	22-7/16 [570]	22-7/16 [570]	22-7/16 [570]	22-7/16 [570]
Weight		lbs [kg]	31 [13.9]	31 [13.9]	31 [13.9]	31 [13.9]	
Outdoor Unit	MCA		A	9.0	9.0	10.0	14.0
	MOCP		A	15	16	18	24
	Dimensions	H	In. [mm]	21-5/8 [550]	21-5/8 [550]	21-5/8 [550]	34-5/8 [880]
		W	In. [mm]	31-1/2 [800]	31-1/2 [800]	31-1/2 [800]	33-1/16 [840]
		D	In. [mm]	11-1/4 [285]	11-1/4 [285]	11-1/4 [285]	13 [330]
	Weight		lbs [kg]	81 [37]	81 [37]	81 [37]	127 [58]
	Air Flow Rate (Cooling/Heating)		CFM	1228/1172	1228/1172	1243/1229	1691/1691
	Sound Pressure Level	Cooling	dB(A)	48	49	49	54
		Heating	dB(A)	50	51	51	55
	Piping	Diameter	Gas (O.D.)	In. [mm]	3/8 [9.52]	3/8 [9.52]	1/2 [12.7]
Liquid (O.D.)			In. [mm]	1/4 [6.35]	1/4 [6.35]	1/4 [6.35]	1/4 [6.35]
Indoor Drain			In. [mm]	1-1/4 [32]	1-1/4 [32]	1-1/4 [32]	1-1/4 [32]
Max. Length			ft [m]	65 [20]	65 [20]	65 [20]	100 [30]
Max. Height		ft [m]	40 [12]	40 [12]	40 [12]	50 [15]	
Electrical	Outdoor-Indoor <sup>5</sup>		V, ph, Hz	208/230, 1, 60	208/230, 1, 60	208/230, 1, 60	208/230, 1, 60
	Recommended Breaker Size		A	15	15	15	15
Refrigerant Type				R410A	R410A	R410A	R410A
Guaranteed Temperature Operation Range	Cooling <sup>6</sup>		°F DB [°C DB]	14.0 to 115.0 [-10.0 to 46.0]	14.0 to 115.0 [-10.0 to 46.0]	14.0 to 115.0 [-10.0 to 46.0]	14.0 to 115.0 [-10.0 to 46.0]
	Heating		°F DB [°C DB]	-4.0 to -75.0 [-20.0 to 24.0]	-4.0 to -75.0 [-20.0 to 24.0]	-4.0 to -75.0 [-20.0 to 24.0]	-4.0 to -75.0 [-20.0 to 24.0]

**Notes:**

AHRI Rated Conditions (Rated data is determined at a fixed compressor speed)

<sup>1</sup>Cooling (Indoor // Outdoor)

<sup>2</sup>Heating at 47°F (Indoor // Outdoor)

<sup>3</sup>Heating at 17°F (Indoor // Outdoor)

<sup>4</sup>Heating at 5°F (Indoor // Outdoor)

°F 80 DB, 67 WB // 95 DB, 75 WB

°F 70 DB, 60 WB // 47 DB, 43 WB

°F 70 DB, 60 WB // 17 DB, 15 WB

°F 70 DB, 60 WB // 5 DB, 4 WB

<sup>5</sup>Indoor units receive power from outdoor units through field-supplied interconnected wiring.

<sup>6</sup>Applications should be restricted to comfort cooling only; equipment cooling applications are not recommended for low ambient temperature conditions.

# CKS Model



<b>Indoor Unit</b> NTXCK5(09/12/15/18) A112A* 	<b>Outdoor Unit</b> 	 *optional PAR-SL100A-E	 *optional TAR-40MAAU	 *optional TAC-YT53CRAU-J	 *optional TAR-CT01MAU-SB
<b>Panel</b> TLP-18FAU (standard grille) TLP-18FAEU (3D i-see Sensor grille)					

Indoor Unit		NTXCK509A112A*		NTXCK512A112A*		NTXCK515A112A*		NTXCK518A112A*		
Outdoor Unit		NTXSKH09A112A*		NTXSKH12A112A*		NTXSKH15A112A*		NTXSKH18A112A*		
Cooling	Capacity	Rated <sup>1</sup>	BTU/H	9,000	12,000	13,700	16,800			
	Capacity Range	Min-Max	BTU/H	4,800-9,000	5,070-12,000	8,500-13,700	9,010-16,800			
	Power Input	Rated <sup>1</sup>	W	600	940	1,095	1,340			
	Moisture Removal	Pints/h		1.9	3.1	3.4	4.2			
	Sensible Heat Factor			0.770	0.710	0.720	0.720			
Heating	Capacity at 47°F	Rated <sup>2</sup>	BTU/H	11,000	13,800	16,400	18,800			
	Capacity Range	Min-Max	BTU/H	7,400-13,200	7,800-14,500	8,300-19,000	8,300-20,000			
	Power Input at 47°F	Rated <sup>2</sup>	W	820	1,170	1,830	2,020			
	Capacity at 17°F	Rated <sup>3</sup>	BTU/H	6,300	8,300	9,700	12,100			
	Capacity at 5°F	Max <sup>4</sup>	BTU/H	11,000	13,800	16,400	18,800			
Efficiency	SEER			20.2	20.3	17.7	19.0			
	EER			15.0	12.7	12.5	12.5			
	HSPF			10	10	9	9.4			
	COP			3.9	3.4	2.6	2.7			
	ENERGY STAR® Certified			Yes	Yes	Yes	Yes			
Indoor Unit	Air Flow Rate - Cooling (Quiet-Lo-Med-Hi-SHi)	Dry	CFM	230-265-300	230-265-335	245-315-405	300-420-475			
		Wet	CFM	207-239-270	207-252-302	221-284-365	270-378-429			
	Air Flow Rate - Heating (Quiet-Lo-Med-Hi-SHi)	Dry	CFM	230-265-335	230-265-335	245-315-405	300-420-475			
		Heating	dB(A)	25-28-31	25-30-34	27-34-39	32-40-43			
	Sound Pressure Level (Quiet-Lo-Med-Hi-SHi)	Cooling	dB(A)	25-28-31	25-30-34	27-34-39	32-40-43			
	External Static Pressure		In. W.G.	—	—	—	—			
	Condensate Lift Mechanism	Max Distance	H	In. [mm]	33 [850]	33 [850]	33 [850]	33 [850]		
			W	In. [mm]	9-21/32 [245]	9-21/32 [245]	9-21/32 [245]	9-21/32 [245]		
		D	In. [mm]	22-7/16 [570]	22-7/16 [570]	22-7/16 [570]	22-7/16 [570]			
	Dimensions	H	In. [mm]	33 [850]	33 [850]	33 [850]	33 [850]			
W		In. [mm]	22-7/16 [570]	22-7/16 [570]	22-7/16 [570]	22-7/16 [570]				
Weight	H	In. [mm]	33 [850]	33 [850]	33 [850]	33 [850]				
	W	In. [mm]	22-7/16 [570]	22-7/16 [570]	22-7/16 [570]	22-7/16 [570]				
Outdoor Unit	MCA	A		14.0	14.0	17.0	17.0			
		MOCP	A		24	24	31	31		
	Dimensions	H	In. [mm]	34-5/8 [880]	34-5/8 [880]	34-5/8 [880]	34-5/8 [880]			
		W	In. [mm]	38-1/16 [840]	33-1/16 [840]	33-1/16 [840]	33-1/16 [840]			
		D	In. [mm]	13 [330]	13 [330]	13 [330]	13 [330]			
	Weight	H	In. [mm]	34-5/8 [880]	34-5/8 [880]	34-5/8 [880]	34-5/8 [880]			
		W	In. [mm]	38-1/16 [840]	33-1/16 [840]	33-1/16 [840]	33-1/16 [840]			
	Air Flow Rate (Cooling/Heating)	Cooling	CFM	1,691/1,691	1,691/1,691	2,020/1,930	2,020/1,930			
		Heating	CFM	1,691/1,691	1,691/1,691	2,020/1,930	2,020/1,930			
	Sound Pressure Level	Cooling	dB(A)	54	54	55	55			
Heating		dB(A)	55	55	55	55				
Piping	Diameter	Gas (O.D.)	In. [mm]	3/8 [9.52]	3/8 [9.52]	1/2 [12.7]	1/2 [12.7]			
		Liquid (O.D.)	In. [mm]	1/4 [6.35]	1/4 [6.35]	1/4 [6.35]	1/4 [6.35]			
		Indoor Drain	In. [mm]	1-1/4 [32]	1-1/4 [32]	1-1/4 [32]	1-1/4 [32]			
	Max. Length	ft [m]		65 [20]	65 [20]	65 [20]	100 [30]			
		ft [m]		40 [12]	40 [12]	40 [12]	50 [15]			
Electrical	Outdoor-Indoor <sup>5</sup>	V, ph, Hz		208/230, 1, 60	208/230, 1, 60	208/230, 1, 60	208/230, 1, 60			
	Recommended Breaker Size	A		15	15	20	20			
Refrigerant Type				R410A	R410A	R410A	R410A			
Guaranteed Temperature Operation Range	Cooling <sup>6</sup>	°F DB [°C DB]		14.0 to 115.0 [-10.0 to 46.0]	14.0 to 115.0 [-10.0 to 46.0]	14.0 to 115.0 [-10.0 to 46.0]	14.0 to 115.0 [-10.0 to 46.0]			
	Heating	°F DB [°C DB]		-13.0 to -75.0 [-25.0 to 24.0]	-13.0 to -75.0 [-25.0 to 24.0]	-13.0 to -75.0 [-25.0 to 24.0]	-13.0 to -75.0 [-25.0 to 24.0]			

Notes:  
 AHRI Rated Conditions (Rated data is determined at a fixed compressor speed)  
 Conditions  
<sup>1</sup>Cooling (Indoor // Outdoor) °F 80 DB, 67 WB // 95 DB, 75 WB  
<sup>2</sup>Heating at 47°F (Indoor // Outdoor) °F 70 DB, 60 WB // 47 DB, 43 WB  
<sup>3</sup>Heating at 17°F (Indoor // Outdoor) °F 70 DB, 60 WB // 17 DB, 15 WB  
<sup>4</sup>Heating at 5°F (Indoor // Outdoor) °F 70 DB, 60 WB // 5 DB, 4 WB  
<sup>5</sup>Indoor units receive power from outdoor units through field-supplied interconnected wiring.  
<sup>6</sup>Applications should be restricted to comfort cooling only; equipment cooling applications are not recommended for low ambient temperature conditions.

# DKS Model

This concealed ceiling-mounted indoor unit model is compact, and fits easily into rooms with lowered ceilings. Highly reliable energy-saving performance makes it a best match choice for concealed unit installations.

NTXDKS(09/12/15/18)A112A\*4

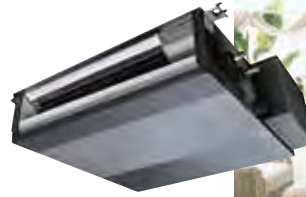

## Compact Ceiling-concealed Units

Only the intake-air grille and outlet vents are visible when using this ceiling-concealed indoor unit. The rest of the unit is conveniently hidden in the ceiling cavity, essentially leaving the ceiling and walls free of bulky looking devices and maintaining a high-class interior décor. The compact units require minimal space and can be installed in buildings with lowered ceilings, where exposed units were the rule in the past.

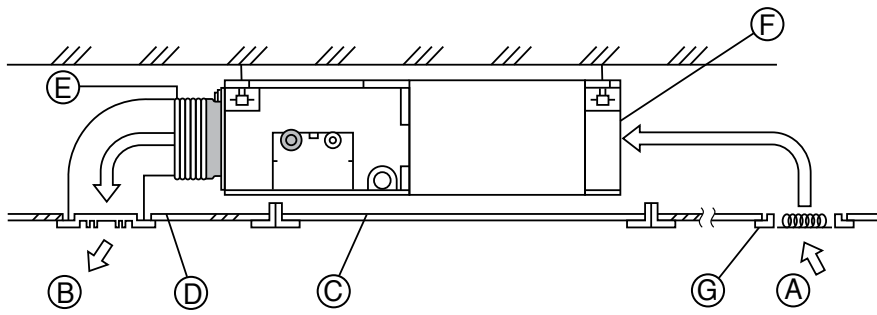

- Ⓐ Air inlet
- Ⓑ Air outlet
- Ⓒ Access door
- Ⓓ Ceiling surface
- Ⓔ Canvas duct
- Ⓕ Air filter
- Ⓖ Inlet grille

## Selection of Fan Speeds and Static Pressure Levels

Three fan speed settings (Low, Medium and High) and four static pressure levels are available for all capacities.

### Static Pressure Levels

DKS09 - 18	0.02-0.06-0.14-0.20 In.W.G.
------------	-----------------------------

### Sound Levels

	Low	Medium	High
09	23 dB(A)	26 dB(A)	30 dB(A)
12	23 dB(A)	28 dB(A)	33 dB(A)
15	30 dB(A)	34 dB(A)	37 dB(A)
18	30 dB(A)	34 dB(A)	38 dB(A)

# DKS Model



**Indoor Unit**



**NTXDKS(09/12/15/18)A112A\***

**Outdoor Unit**



**NTXSKS(09/12/15) A112A\***



**NTXSKS18A112A\***

**Remote Controller**



**\*optional**



**\*optional TAR-40MAAU**



**\*optional TAR-CT01MAU-SB**



**\*optional TAC-YT53CRAU-J**



AUTO



ACO



Auto Restart



Low Temp Cooling



VAG



Group Control



M-NET connection



USNAP



Optional



T-STAT



MX connection



Drain Lift Up



Flare connection



Self Diagnosis



Failure Recall



















Indoor Unit				NTXDKS09A112A*	NTXDKS12A112A*	NTXDKS15A112A*	NTXDKS18A112A*
Outdoor Unit				NTXSKS09A112A*	NTXSKS12A112A*	NTXSKS15A112A*	NTXSKS18A112A*
Cooling	Capacity	Rated <sup>1</sup>	BTU/H	9,000	12,000	15,000	18,000
	Capacity Range	Min-Max	BTU/H	3,900-9,000	4,000-12,000	5,200-15,000	6,100-18,000
	Power Input	Rated <sup>1</sup>	W	700	930	1,150	1,310
	Moisture Removal	Pints/h		1.5	1.9	1.9	2.8
	Sensible Heat Factor			0.820	0.820	0.860	0.820
Heating	Capacity at 47°F	Rated <sup>2</sup>	BTU/H	12,000	15,000	18,000	21,600
	Capacity Range	Min-Max	BTU/H	4,200	4,800	5,000	8,100
	Power Input at 47°F	Rated <sup>2</sup>	W	1,100	1,330	1,440	1,580
	Capacity at 17°F	Rated <sup>3</sup>	BTU/H	7,600	10,000	11,700	13,900
	Capacity at 5°F	Max <sup>4</sup>	BTU/H	6,700	9,000	11,900	13,100
Efficiency	SEER			18.8	20.5	19.0	22.0
	EER			12.8	12.9	13.0	13.7
	HSPF			11.00	12.40	11.40	13.10
	COP			3.1	3.3	3.6	4.0
	ENERGY STAR® Certified			Yes	Yes	Yes	Yes
Indoor Unit	Air Flow Rate - Cooling (Quiet-Lo-Med-Hi-SHi)	Dry	CFM	194-247-317	247-317-388	353-441-529	423-529-635
		Wet	CFM	174-222-285	222-285-349	317-396-476	381-476-572
	Air Flow Rate - Heating (Quiet-Lo-Med-Hi-SHi)	Dry	CFM	194-247-317	247-317-388	353-441-529	423-529-635
	Sound Pressure Level (Quiet-Lo-Med-Hi-SHi)	Cooling	dB(A)	23-26-30	23-28-33	30-34-37	30-34-38
		Heating	dB(A)	23-26-30	23-28-33	30-34-37	30-34-38
	External Static Pressure		In. W.G.	0.02-0.06-0.14-0.2	0.02-0.06-0.14-0.2	0.02-0.06-0.14-0.2	0.02-0.06-0.14-0.2
	Condensate Lift Mechanism	Max Distance	In. [mm]	2121/32 [550]	21-21/32 [550]	21-21/32 [550]	21-21/32 [550]
		Dimensions	H	In. [mm]	7-7/8 [200]	7-7/8 [200]	7-7/8 [200]
	W		In. [mm]	31-7/8 [790]	39 [990]	39 [990]	46-7/8 [1190]
	D		In. [mm]	27-9/16 [700]	27-9/16 [700]	27-9/16 [700]	27-9/16 [700]
Weight		lbs [kg]	42 [19.0]	50 [22.0]	54 [24.0]	62 [28.0]	
Outdoor Unit	MCA	A		9.0	9.0	10.0	14.0
	MOCP	A		15	16	18	24
	Dimensions	H	In. [mm]	21-5/8 [550]	21-5/8 [550]	21-5/8 [550]	34-5/8 [880]
		W	In. [mm]	31-1/2 [800]	31-1/2 [800]	31-1/2 [800]	33-1/16 [840]
		D	In. [mm]	11-1/4 [285]	11-1/4 [285]	11-1/4 [285]	13 [330]
	Weight		lbs [kg]	81 [37]	81 [37]	81 [37]	127 [58]
	Air Flow Rate (Cooling/Heating)		CFM	1228/1172	1228/1172	1243/1229	1691/1691
Sound Pressure Level	Cooling	dB(A)	48	49	49	54	
	Heating	dB(A)	50	51	51	55	
Piping	Diameter	Gas (O.D.)	In. [mm]	3/8 [9.52]	3/8 [9.52]	1/2 [12.7]	1/2 [12.7]
		Liquid (O.D.)	In. [mm]	1/4 [6.35]	1/4 [6.35]	1/4 [6.35]	1/4 [6.35]
		Indoor Drain	In. [mm]	1-1/4 [32]	1-1/4 [32]	1-1/4 [32]	1-1/4 [32]
	Max. Length		ft [m]	65 [20]	65 [20]	65 [20]	100 [30]
Max. Height		ft [m]	40 [12]	40 [12]	40 [12]	50 [15]	
Electrical	Outdoor-Indoor <sup>5</sup>	V, ph, Hz		208/230, 1, 60	208/230, 1, 60	208/230, 1, 60	208/230, 1, 60
	Recommended Breaker Size	A		15	15	15	15
Refrigerant Type				R410A	R410A	R410A	R410A
Guaranteed Temperature Operation Range	Cooling <sup>6</sup>	°F DB [°C DB]		14.0 to 115.0 [-10.0 to 46.0]	14.0 to 115.0 [-10.0 to 46.0]	14.0 to 115.0 [-10.0 to 46.0]	14.0 to 115.0 [-10.0 to 46.0]
	Heating	°F DB [°C DB]		-4.0 to -75.0 [-20.0 to 24.0]	-4.0 to -75.0 [-20.0 to 24.0]	-4.0 to -75.0 [-20.0 to 24.0]	-4.0 to -75.0 [-20.0 to 24.0]

Notes:  
 AHRI Rated Conditions (Rated data is determined at a fixed compressor speed)  
 Conditions  
<sup>1</sup>Cooling (Indoor // Outdoor) °F 80 DB, 67 WB // 95 DB, 75 WB  
<sup>2</sup>Heating at 47°F (Indoor // Outdoor) °F 70 DB, 60 WB // 47 DB, 43 WB  
<sup>3</sup>Heating at 17°F (Indoor // Outdoor) °F 70 DB, 60 WB // 17 DB, 15 WB  
<sup>4</sup>Heating at 5°F (Indoor // Outdoor) °F 70 DB, 60 WB // 5 DB, 4 WB  
<sup>5</sup>Indoor units receive power from outdoor units through field-supplied interconnected wiring.  
<sup>6</sup>Applications should be restricted to comfort cooling only; equipment cooling applications are not recommended for low ambient temperature conditions.



# DKS Model



<b>Indoor Unit</b>  NTXDKS(09/12/15/18)A112A*	<b>Outdoor Unit</b>  NTXSKH(09/12/15/18)A112A*	 *optional	 *optional TAR-40MAAU	 *optional TAR-CT01MAU-SB	 *optional TAC-YT53CRAU-J
<div style="display: flex; justify-content: space-around; align-items: center;"> <div style="text-align: center;">  </div> <div style="text-align: center;">  </div> <div style="text-align: center;">  </div> <div style="text-align: center;">  </div> <div style="text-align: center;">  </div> <div style="text-align: center;">  </div> <div style="text-align: center;">  </div> <div style="text-align: center;">  </div> <div style="text-align: center;">  </div> <div style="text-align: center;">  </div> <div style="text-align: center;">  </div> <div style="text-align: center;">  </div> <div style="text-align: center;">  </div> <div style="text-align: center;">  </div> <div style="text-align: center;">  </div> <div style="text-align: center;">  </div> </div>					

Indoor Unit				NTXDKS09A112A*	NTXDKS12A112A*	NTXDKS15A112A*	NTXDKS18A112A*	
Outdoor Unit				NTXSKH09A112A*	NTXSKH12A112A*	NTXSKH15A112A*	NTXSKH18A112A*	
Cooling	Capacity	Rated <sup>1</sup>	BTU/H	9,000	12,000	15,000	18,000	
	Capacity Range	Min-Max	BTU/H	4,500-9,000	5,210-12,000	9,000-15,000	9,200-18,000	
	Power Input	Rated <sup>1</sup>	W	690	920	1,200	1,370	
	Moisture Removal	Pints/h		1.7	2.5	2.8	2.0	
	Sensible Heat Factor			0.790	0.760	0.800	0.870	
Heating	Capacity at 47°F	Rated <sup>2</sup>	BTU/H	12,500	15,000	18,000	21,600	
	Capacity Range	Min-Max	BTU/H	8,100-13,300	7,700-18,000	8,600-22,400	8,800-28,000	
	Power Input at 47°F	Rated <sup>2</sup>	W	1,300	1,120	1,920	1,840	
	Capacity at 17°F	Rated <sup>3</sup>	BTU/H	8,700	9,000	12,200	14,200	
	Capacity at 5°F	Max <sup>4</sup>	BTU/H	12,500	15,000	18,000	21,600	
Efficiency	SEER			17.3	19.0	17.3	19.1	
	EER			13.0	13.0	12.5	13.1	
	HSPF			9.8	10.2	9.5	10.9	
	COP			2.8	3.9	2.7	3.4	
	ENERGY STAR® Certified			Yes	Yes	Yes	Yes	
Indoor Unit	Air Flow Rate - Cooling (Quiet-Lo-Med-Hi-SHi)	Dry	CFM	194-247-317	247-317-388	353-441-529	423-529-635	
		Wet	CFM	174-222-285	222-285-349	317-396-476	381-476-572	
	Air Flow Rate - Heating (Quiet-Lo-Med-Hi-SHi)	Dry	CFM	194-247-317	247-317-388	353-441-529	423-529-635	
	Sound Pressure Level (Quiet-Lo-Med-Hi-SHi)	Cooling	dB(A)	23-26-30	23-28-33	30-34-37	30-34-38	
		Heating	dB(A)	23-26-30	23-28-33	30-34-37	30-34-38	
	External Static Pressure		In. W.G.	0.02-0.06-0.14-0.2	0.02-0.06-0.14-0.2	0.02-0.06-0.14-0.2	0.02-0.06-0.14-0.2	
	Condensate Lift Mechanism	Max Distance		In. [mm]	2121/32 [550]	21-21/32 [550]	21-21/32 [550]	21-21/32 [550]
		Dimensions	H	In. [mm]	7-7/8 [200]	7-7/8 [200]	7-7/8 [200]	7-7/8 [200]
	W		In. [mm]	31-7/8 [790]	39 [990]	39 [990]	46-7/8 [1190]	
	D		In. [mm]	27-9/16 [700]	27-9/16 [700]	27-9/16 [700]	27-9/16 [700]	
Weight		lbs [kg]	42 [19.0]	50 [22.0]	54 [24.0]	62 [28.0]		
Outdoor Unit	MCA		A	14.0	14.0	17.0	17.0	
	MOCP		A	24	24	31	31	
	Dimensions	H	In. [mm]	34-5/8 [880]	34-5/8 [880]	34-5/8 [880]	34-5/8 [880]	
		W	In. [mm]	38-1/16 [840]	33-1/16 [840]	33-1/16 [840]	33-1/16 [840]	
		D	In. [mm]	13 [330]	13 [330]	13 [330]	13 [330]	
	Weight		lbs [kg]	129 [58.5]	129 [58.5]	131 [59.5]	131 [59.5]	
	Air Flow Rate (Cooling/Heating)		CFM	1,691/1,691	1,691/1,691	2,020/1,930	2,020/1,930	
Sound Pressure Level	Cooling	dB(A)	54	54	55	55		
	Heating	dB(A)	55	55	55	55		
Piping	Diameter	Gas (O.D.)	In. [mm]	3/8 [9.52]	3/8 [9.52]	1/2 [12.7]	1/2 [12.7]	
		Liquid (O.D.)	In. [mm]	1/4 [6.35]	1/4 [6.35]	1/4 [6.35]	1/4 [6.35]	
		Indoor Drain	In. [mm]	1-1/4 [32]	1-1/4 [32]	1-1/4 [32]	1-1/4 [32]	
	Max. Length		ft [m]	65 [20]	65 [20]	65 [20]	100 [30]	
Max. Height		ft [m]	40 [12]	40 [12]	40 [12]	50 [15]		
Electrical	Outdoor-Indoor <sup>5</sup>		V, ph, Hz	208/230, 1, 60	208/230, 1, 60	208/230, 1, 60	208/230, 1, 60	
	Recommended Breaker Size		A	15	15	20	20	
Refrigerant Type				R410A	R410A	R410A	R410A	
Guaranteed Temperature Operation Range	Cooling <sup>6</sup>		°F DB [°C DB]	14.0 to 115.0 [-10.0 to 46.0]	14.0 to 115.0 [-10.0 to 46.0]	14.0 to 115.0 [-10.0 to 46.0]	14.0 to 115.0 [-10.0 to 46.0]	
	Heating		°F DB [°C DB]	-13.0 to -75.0 [-25.0 to 24.0]	-13.0 to -75.0 [-25.0 to 24.0]	-13.0 to -75.0 [-25.0 to 24.0]	-13.0 to -75.0 [-25.0 to 24.0]	

Notes:  
 AHRI Rated Conditions (Rated data is determined at a fixed compressor speed)  
 Conditions  
<sup>1</sup>Cooling (Indoor // Outdoor) °F 80 DB, 67 WB // 95 DB, 75 WB  
<sup>2</sup>Heating at 47°F (Indoor // Outdoor) °F 70 DB, 60 WB // 47 DB, 43 WB  
<sup>3</sup>Heating at 17°F (Indoor // Outdoor) °F 70 DB, 60 WB // 17 DB, 15 WB  
<sup>4</sup>Heating at 5°F (Indoor // Outdoor) °F 70 DB, 60 WB // 5 DB, 4 WB  
<sup>5</sup>Indoor units receive power from outdoor units through field-supplied interconnected wiring.  
<sup>6</sup>Applications should be restricted to comfort cooling only; equipment cooling applications are not recommended for low ambient temperature conditions.

# PEAD Model

The thin, ceiling-concealed indoor units of this model are the perfect answer for the air conditioning needs of buildings with minimum ceiling installation space and wide-ranging external static pressure. Energy-saving efficiency has been improved, reducing electricity consumption and contributing to a further reduction in operating cost.



## Compact Indoor Units

The height is only 9-7/8" for all sizes of this model from 12 to 42 kBTU/H. This makes it possible for the unit to be installed in low ceilings with minimal clearance space.



## External Static Pressure

External static pressure conversion can be set up to five settings. Capable of being set to a maximum of 0.60 In.W.G., units are applicable to a wide range of building types.

### External static pressure

Model	12	18	24	30	36	42
PEAD-A AA	0.14-0.20-0.28-0.40-0.60 In. W.G.					

## High Energy Efficiency

SEER/HSPF has been greatly improved, and 12,000/18,000 BTU/H models have been added to the line-up.

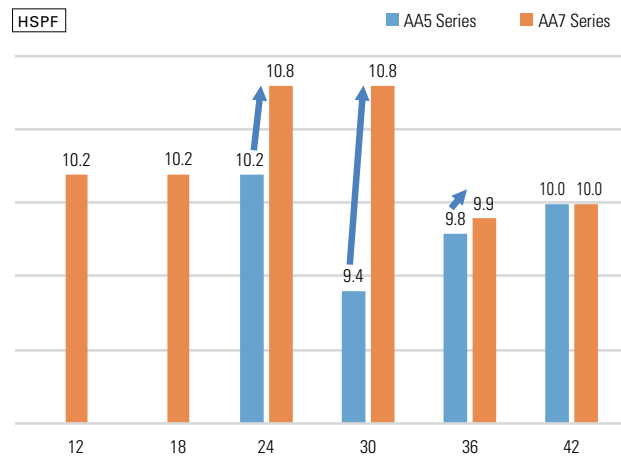
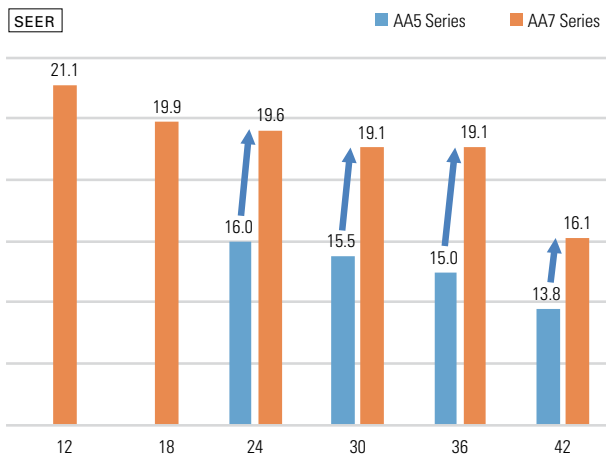

## Built-in Drain Lift Mechanism

All models feature a built-in drain lift mechanism for removal of condensate. The unit's fail-safe mechanism recognizes when there is a high liquid level in the condensate pan and turns off the indoor fan and the outdoor unit compressor to prevent overflow.

# PEAD Model



**Indoor Unit**



**PEAD-A09/12/15/18/24/30/36AA7**

**Outdoor Unit**



**NTXSKS(09/12/15) A112A\***



**NTXSKS(18/24/30/36)A112A\***

**Remote Controller**



**\*optional TAR-CT01MAU-SB**



**\*optional TAR-40MAAU**



**\*optional TAC-YT53CRAU-J**

















Indoor Unit				PEAD-A09AA7	PEAD-A12AA7	PEAD-A15AA7	PEAD-A18AA7	PEAD-A24AA7	PEAD-A30AA7	PEAD-A36AA7
Outdoor Unit				NTXSK-S09A112A*	NTXSK-S12A112A*	NTXSK-S15A112A*	NTXSK-S18A112A*	NTXSK-S24A112A*	NTXSK-S30A112A*	NTXSK-S36A112A*
Cooling	Capacity	Rated <sup>1</sup>	BTU/H	9,000	12,000	15,000	18,000	24,000	27,000	33,000
	Capacity Range	Min-Max	BTU/H	4,300-9,000	4,400-12,000	5,500-15,000	6,200-18,000	12,000-24,000	13,200-27,000	14,000-33,000
	Power Input	Rated <sup>1</sup>	W	720	930	1,150	1,270	1,920	2,160	3,510
	Moisture Removal	Pints/h		0.8	1.1	1.3	3.2	4.9	3.9	4.8
	Sensible Heat Factor			0.900	0.900	0.900	0.800	0.770	0.840	0.840
Heating	Capacity at 47°F	Rated <sup>2</sup>	BTU/H	12,000	15,000	18,000	21,600	25,000	30,000	33,400
	Capacity Range	Min-Max	BTU/H	3,960-13,000	4,800-17,000	4,900-21,500	8,120-25,600	14,400-28,000	15,860-33,000	14,750-36,000
	Power Input at 47°F	Rated <sup>2</sup>	W	900	1,160	1,350	1,600	1,990	2,410	3,170
	Capacity at 17°F	Rated <sup>3</sup>	BTU/H	7,600	9,900	11,300	14,000	15,000	22,400	23,000
	Capacity at 5°F	Max <sup>4</sup>	BTU/H	6,100	7,900	10,100	12,000	—	—	—
Efficiency	SEER			19.7	20.5	19.2	19.8	18.0	18.0	16.0
	EER			12.5	12.9	13.0	14.1	12.5	12.5	9.4
	HSPF			12.6	13	11.6	12.9	11.2	12.6	11.6
	COP			3.9	3.7	3.9	3.9	3.6	3.6	3.0
	ENERGY STAR® Certified			Yes	Yes	Yes	Yes	Yes	Yes	Yes
Indoor Unit	Air Flow Rate - Cooling (Quiet-Lo-Med-Hi-SH)	Dry	CFM	282-318-353	353-424-494	424-512-600	424-512-600	512-636-742	618-742-883	847-1024-1201
		Wet	CFM	254-286-318	318-382-445	382-461-540	382-461-540	461-572-667	556-668-795	762-922-1081
	Air Flow Rate - Heating (Quiet-Lo-Med-Hi-SH)	Dry	CFM	282-318-353	353-424-494	424-512-600	424-512-600	512-636-742	618-742-883	847-1024-1201
	Sound Pressure Level (Quiet-Lo-Med-Hi-SH)	Cooling	dB(A)	24-26-28	28-30-34	30-33-37	30-33-37	30-33-37	30-34-39	33-38-42
		Heating	dB(A)	24-26-28	28-30-34	30-33-37	30-33-37	30-33-37	30-34-39	33-38-42
	External Static Pressure		In. W.G.	0.14-0.2-0.28-0.4-0.6	0.14-0.2-0.28-0.4-0.6	0.14-0.2-0.28-0.4-0.6	0.14-0.2-0.28-0.4-0.6	0.14-0.2-0.28-0.4-0.6	0.14-0.2-0.28-0.4-0.6	0.14-0.2-0.28-0.4-0.6
	Condensate Lift Mechanism	Max Distance	In. [mm]	279/16 [700]	27-9/16 [700]	279/16 [700]	27-9/16 [700]	27-9/16 [700]	27-9/16 [700]	27-9/16 [700]
		H	In. [mm]	9-7/8 [250]	9-7/8 [250]	9-7/8 [250]	9-7/8 [250]	9-7/8 [250]	9-7/8 [250]	9-7/8 [250]
	Dimensions	W	In. [mm]	35-7/16 [900]	35-7/16 [900]	35-7/16 [900]	35-7/16 [900]	43-5/16 [1100]	43-5/16 [1100]	55-1/8 [1400]
D		In. [mm]	28-7/8 [732]	28-7/8 [732]	28-7/8 [732]	28-7/8 [732]	28-7/8 [732]	28-7/8 [732]	28-7/8 [732]	
Weight		lbs [kg]	58 [26]	58 [26]	62 [28]	62 [28]	69 [31]	69 [31]	86 [39]	
Outdoor Unit	MCA	A		9.0	9.0	10.0	14.0	17.0	17.0	
	MOCP	A		15	16	18	24	31	31	
	Dimensions	H	In. [mm]	21-5/8 [550]	21-5/8 [550]	21-5/8 [550]	34-5/8 [880]	34-5/8 [880]	34-5/8 [880]	34-5/8 [880]
		W	In. [mm]	31-1/2 [800]	31-1/2 [800]	31-1/2 [800]	33-1/16 [840]	33-1/16 [840]	33-1/16 [840]	33-1/16 [840]
		D	In. [mm]	11-1/4 [285]	11-1/4 [285]	11-1/4 [285]	13 [330]	13 [330]	13 [330]	13 [330]
	Weight	lbs [kg]	81 [37]	81 [37]	81 [37]	127 [58]	129 [58.5]	129 [58.5]	129 [58.5]	
	Air Flow Rate (Cooling/Heating)	CFM		1228/1172	1228/1172	1243/1229	1691/1691	2020/1930	2020/1930	2020/1930
	Sound Pressure Level	Cooling	dB(A)	48	49	49	54	55	55	55
		Heating	dB(A)	50	51	51	55	55	55	55
	Piping	Diameter	Gas (O.D.)	In. [mm]	3/8 [9.52]	3/8 [9.52]	1/2 [12.7]	1/2 [12.7]	5/8 [15.88]	5/8 [15.88]
Liquid (O.D.)			In. [mm]	1/4 [6.35]	1/4 [6.35]	1/4 [6.35]	1/4 [6.35]	3/8 [9.52]	3/8 [9.52]	3/8 [9.52]
Indoor Drain			In. [mm]	1-1/4 [32]	1-1/4 [32]	1-1/4 [32]	1-1/4 [32]	1-1/4 [32]	1-1/4 [32]	1-1/4 [32]
Max. Length		ft [m]		65 [20]	65 [20]	65 [20]	100 [30]	100 [30]	100 [30]	
Max. Height	ft [m]		40 [12]	40 [12]	40 [12]	50 [15]	100 [30]	100 [30]		
Electrical	Outdoor-Indoor <sup>5</sup>	V, ph, Hz		208/230, 1, 60	208/230, 1, 60	208/230, 1, 60	208/230, 1, 60	208/230, 1, 60	208/230, 1, 60	208/230, 1, 60
	Recommended Breaker Size	A		15	15	15	15	20	20	
Refrigerant Type				R410A	R410A	R410A	R410A	R410A	R410A	R410A
Guaranteed Temperature Operation Range	Cooling <sup>6</sup>	°F DB [°C DB]		14.0 to 115.0 [-10.0 to 46.0]	14.0 to 115.0 [-10.0 to 46.0]	14.0 to 115.0 [-10.0 to 46.0]	14.0 to 115.0 [-10.0 to 46.0]	14.0 to 115.0 [-10.0 to 46.0]	14.0 to 115.0 [-10.0 to 46.0]	14.0 to 115.0 [-10.0 to 46.0]
	Heating	°F DB [°C DB]		-4.0 to -75.0 [-20.0 to 24.0]	-4.0 to -75.0 [-20.0 to 24.0]	-4.0 to -75.0 [-20.0 to 24.0]	-4.0 to -75.0 [-20.0 to 24.0]	-4.0 to -75.0 [-10.0 to 24.0]	-4.0 to -75.0 [-10.0 to 24.0]	-4.0 to -75.0 [-10.0 to 24.0]

Notes:  
 AHR1 Rated Conditions  
 (Rated data is determined at a fixed compressor speed)  
 Conditions  
<sup>1</sup>Cooling (Indoor // Outdoor) °F 80 DB, 67 WB // 95 DB, 75 WB  
<sup>2</sup>Heating at 47°F (Indoor // Outdoor) °F 70 DB, 60 WB // 47 DB, 43 WB  
<sup>3</sup>Heating at 17°F (Indoor // Outdoor) °F 70 DB, 60 WB // 17 DB, 15 WB  
<sup>4</sup>Heating at 5°F (Indoor // Outdoor) °F 70 DB, 60 WB // 5 DB, 4 WB  
<sup>5</sup>Indoor units receive power from outdoor units through field-supplied interconnected wiring.  
<sup>6</sup>Applications should be restricted to comfort cooling only; equipment cooling applications are not recommended for low ambient temperature conditions.

# PEAD Model



<b>Indoor Unit</b>  <b>PEAD-A09/12/15/18AA7</b>	<b>Outdoor Unit</b>  <b>NTXSKH(09/12/15/18)A112A*</b>	 <b>*optional</b>	 <b>*optional TAR-40MAAU</b>	 <b>*optional TAR-CT01MAU-SB</b>	 <b>*optional TAC-YT53CRAU-J</b>

Indoor Unit				PEAD-A09AA7	PEAD-A12AA7	PEAD-A15AA7	PEAD-A18AA7
Outdoor Unit				NTXSKH09A112A*	NTXSKH12A112A*	NTXSKH15A112A*	NTXSKH18A112A*
Cooling	Capacity	Rated <sup>1</sup>	BTU/H	9,000	12,000	15,000	18,000
	Capacity Range	Min-Max	BTU/H	5,000-9,000	5,770-12,000	9,600-15,000	9,320-18,000
	Power Input	Rated <sup>1</sup>	W	650	850	1,190	1,400
	Moisture Removal	Pints/h		1.4	1.9	2.4	3.6
	Sensible Heat Factor			0.820	0.820	0.820	0.780
Heating	Capacity at 47°F	Rated <sup>2</sup>	BTU/H	12,000	15,000	18,000	21,600
	Capacity Range	Min-Max	BTU/H	8,200-14,000	7,900-18,000	8,800-23,000	8,800-28,000
	Power Input at 47°F	Rated <sup>2</sup>	W	910	1,100	1,710	1,890
	Capacity at 17°F	Rated <sup>3</sup>	BTU/H	6,800	9,000	11,700	14,200
		Max	BTU/H	12,000	15,000	18,000	21,600
	Capacity at 5°F	Max <sup>4</sup>	BTU/H	12,000	15,000	18,000	21,600
Efficiency	SEER			17.8	19.3	18.3	18.9
	EER			13.8	14.1	12.6	12.8
	HSPF			10.8	11	9.9	10.8
	COP			3.8	3.9	3.0	3.3
	ENERGY STAR® Certified			Yes	Yes	Yes	Yes
Indoor Unit	Air Flow Rate - Cooling (Quiet-Lo-Med-Hi-SHi)	Dry	CFM	282-318-353	353-424-494	424-512-600	424-512-600
		Wet	CFM	254-286-318	318-382-445	382-461-540	382-461-540
	Air Flow Rate - Heating (Quiet-Lo-Med-Hi-SHi)	Dry	CFM	282-318-353	353-424-494	424-512-600	424-512-600
	Sound Pressure Level (Quiet-Lo-Med-Hi-SHi)	Cooling	dB(A)	24-26-28	28-30-34	30-33-37	30-33-37
		Heating	dB(A)	24-26-28	28-30-34	30-33-37	30-33-37
	External Static Pressure		In. W.G.	0.14-0.2-0.28-0.4-0.6	0.14-0.2-0.28-0.4-0.6	0.14-0.2-0.28-0.4-0.6	0.14-0.2-0.28-0.4-0.6
	Condensate Lift Mechanism	Max Distance	In. [mm]	279/16 [700]	27-9/16 [700]	279/16 [700]	27-9/16 [700]
		H	In. [mm]	9-7/8 [250]	9-7/8 [250]	9-7/8 [250]	9-7/8 [250]
	Dimensions	W	In. [mm]	35-7/16 [900]	35-7/16 [900]	35-7/16 [900]	35-7/16 [900]
D		In. [mm]	28-7/8 [732]	28-7/8 [732]	28-7/8 [732]	28-7/8 [732]	
Weight		lbs [kg]	58 [26]	58 [26]	62 [28]	62 [28]	
Outdoor Unit	MCA		A	14.0	14.0	17.0	17.0
	MOCP		A	24	24	31	31
	Dimensions	H	In. [mm]	34-5/8 [880]	34-5/8 [880]	34-5/8 [880]	34-5/8 [880]
		W	In. [mm]	38-1/16 [840]	33-1/16 [840]	33-1/16 [840]	33-1/16 [840]
		D	In. [mm]	13 [330]	13 [330]	13 [330]	13 [330]
	Weight		lbs [kg]	129 [58.5]	129 [58.5]	131 [59.5]	131 [59.5]
	Air Flow Rate (Cooling/Heating)		CFM	1,691/1,691	1,691/1,691	2,020/1,930	2,020/1,930
	Sound Pressure Level	Cooling	dB(A)	54	54	55	55
		Heating	dB(A)	55	55	55	55
	Piping	Diameter	Gas (O.D.)	In. [mm]	3/8 [9.52]	3/8 [9.52]	1/2 [12.7]
Liquid (O.D.)			In. [mm]	1/4 [6.35]	1/4 [6.35]	1/4 [6.35]	1/4 [6.35]
Indoor Drain			In. [mm]	1-1/4 [32]	1-1/4 [32]	1-1/4 [32]	1-1/4 [32]
Max. Length			ft [m]	65 [20]	65 [20]	65 [20]	100 [30]
Max. Height		ft [m]	40 [12]	40 [12]	40 [12]	50 [15]	
Electrical	Outdoor-Indoor <sup>5</sup>		V, ph, Hz	208/230, 1, 60	208/230, 1, 60	208/230, 1, 60	208/230, 1, 60
	Recommended Breaker Size		A	15	15	20	20
Refrigerant Type				R410A	R410A	R410A	R410A
Guaranteed Temperature Operation Range	Cooling <sup>6</sup>	°F DB [°C DB]		14.0 to 115.0 [-10.0 to 46.0]	14.0 to 115.0 [-10.0 to 46.0]	14.0 to 115.0 [-10.0 to 46.0]	14.0 to 115.0 [-10.0 to 46.0]
	Heating	°F DB [°C DB]		-13.0 to -75.0 [-25.0 to 24.0]	-13.0 to -75.0 [-25.0 to 24.0]	-13.0 to -75.0 [-25.0 to 24.0]	-13.0 to -75.0 [-25.0 to 24.0]

Notes:  
 AHRI Rated Conditions (Rated data is determined at a fixed compressor speed)  
 Conditions  
<sup>1</sup>Cooling (Indoor // Outdoor) °F 80 DB, 67 WB // 95 DB, 75 WB  
<sup>2</sup>Heating at 47°F (Indoor // Outdoor) °F 70 DB, 60 WB // 47 DB, 43 WB  
<sup>3</sup>Heating at 17°F (Indoor // Outdoor) °F 70 DB, 60 WB // 17 DB, 15 WB  
<sup>4</sup>Heating at 5°F (Indoor // Outdoor) °F 70 DB, 60 WB // 5 DB, 4 WB  
<sup>5</sup>Indoor units receive power from outdoor units through field-supplied interconnected wiring.  
<sup>6</sup>Applications should be restricted to comfort cooling only; equipment cooling applications are not recommended for low ambient temperature conditions.





# P Series





# SELECTION

Line-up includes a selection of six indoor units and three categories of outdoor units. Easily construct a system that best matches room air conditioning needs.

## STEP 1 SELECT INDOOR UNIT

Choose from Cooling Only, Heat Pump, or Hyper-heating models.



## STEP 2 SELECT OUTDOOR UNIT

Choose from Cooling Only, Heat Pump, or Hyper-heating models.

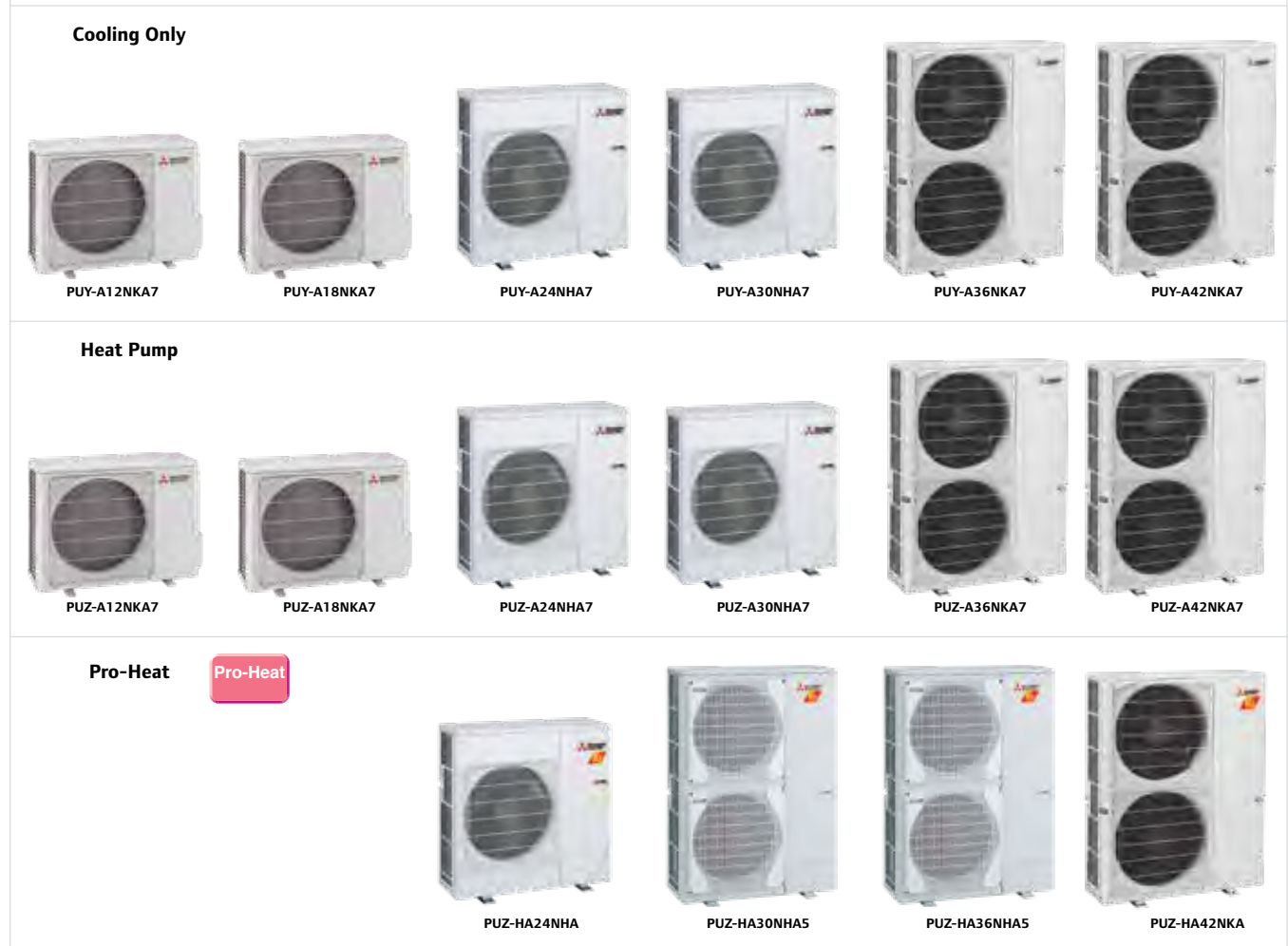

# P-SERIES

The P-Series is designed to achieve industry-leading seasonal energy-efficiency through use of new technologies and high-performance compressors. Installation is easy thanks to outdoor units with a side-flow configuration, a maximum piping length of 225 ft. PUY only and pipe-replacement technologies.



## Industry Leading Energy Efficiency

Industry-leading energy efficiency has been achieved through optimization of a newly designed compressor and the use of the latest energy-saving technologies. All compressors offer high performance due to advanced variable-speed INVERTER-drive technology, which varies the compressor speed dynamically to continuously adapt to the conditioning requirements of the room.

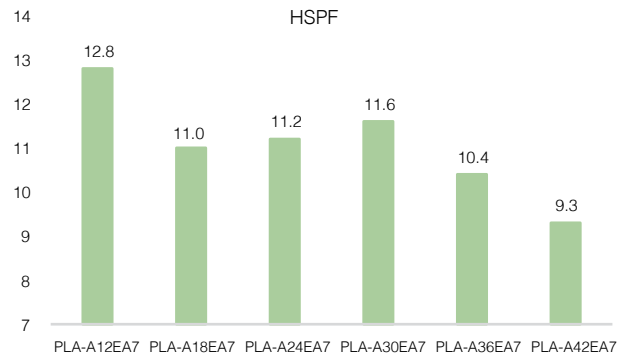
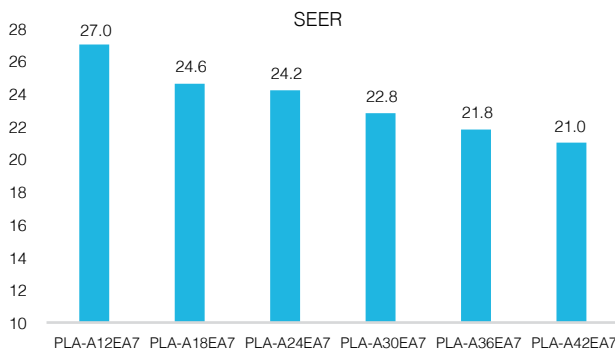

## Advanced Energy-saving Technology

### Highly efficient fan for outdoor unit

#### Fan opening of 21-3/4" (A36-42)

The opening for the fan in the outdoor unit is 21-3/4" in diameter. By exchanging heat more efficiently, this will contribute to energy-saving and low noise level.

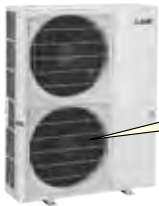

The opening for the fan in the outdoor unit is 21-3/4" in diameter.

#### Improved fan (A36-42)

A newly designed fan has been adopted, increasing airflow capacity and reducing operation noise.

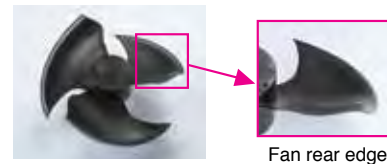

Fan rear edge

### Highly efficient heat exchanger

#### High-density heat exchanger (A36-42)

The A36-42 units use 5/16"-diameter pipe. The high-density heat exchanger contributes to efficient heat exchange and reduces the amount of refrigerant used, which is better for the environment.

2 lines, 64 columns (A36-42)

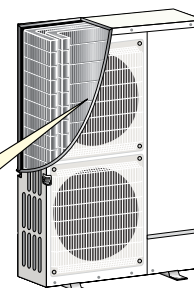

# COOLING ONLY

# PUY Model

Low ambient cooling operation range



## High Reliability and Performance in Low Ambient Conditions

By changing the fan speed control in low ambient temperatures, the PUY model can offer stable operation down to -40° F. This model range is well suited for cooling needs in cold regions.

\*Optional Air Protection Guide/Wind Baffle is needed when ambient temperature is under 23° F.

## Low ambient cooling operation range

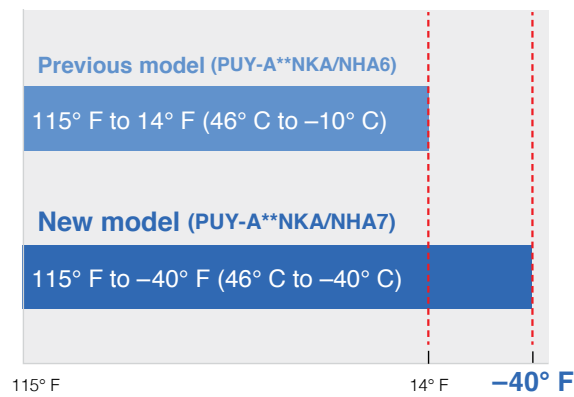

## High capacity at low ambient condition

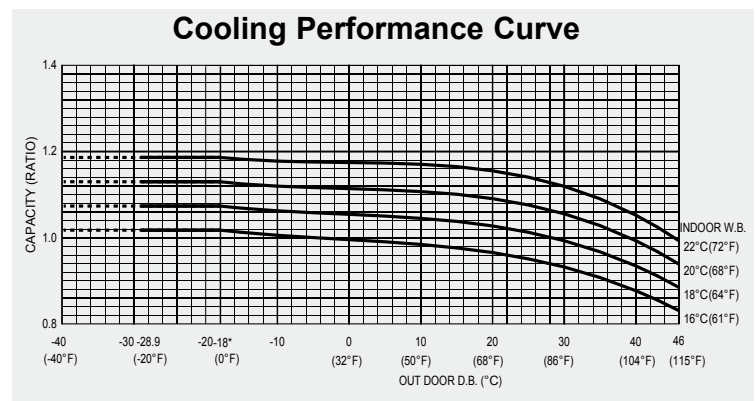

## Quick auto restart after power failure

In case of power failures, the time until auto restart became shorter from 180 seconds to 60 seconds. The unit will quickly restart with the same operation mode as before the power failure.

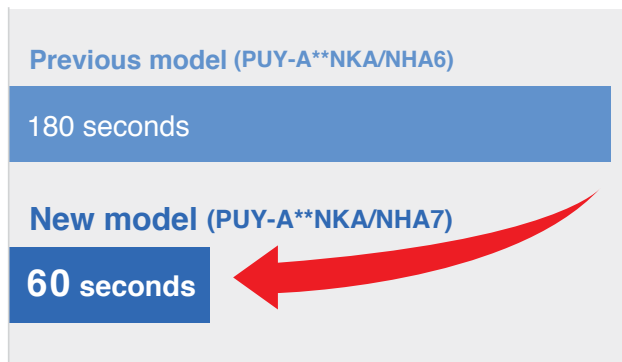

## Backup rotation function

The two units can operate alternately so the units can maintain their quality for a longer period of time, and so that even if there is trouble with one unit, the other unit will keep operating.

\*Can only be used with TAR-40MAU controller

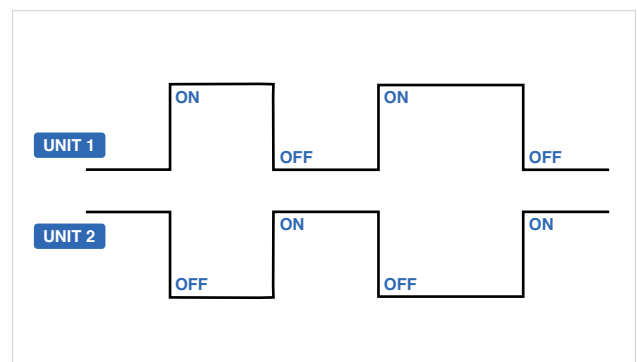

## Continuous operation

Control algorithm for stable continuous operation to meet cooling requirements all year round. The unit will quickly restart with the same operation mode as before the power failure.

# HEAT PUMP PUZ Model



## Quiet and Comfort

### Sound level

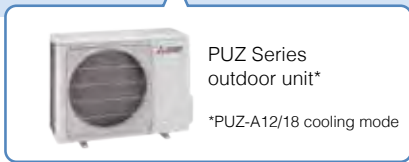
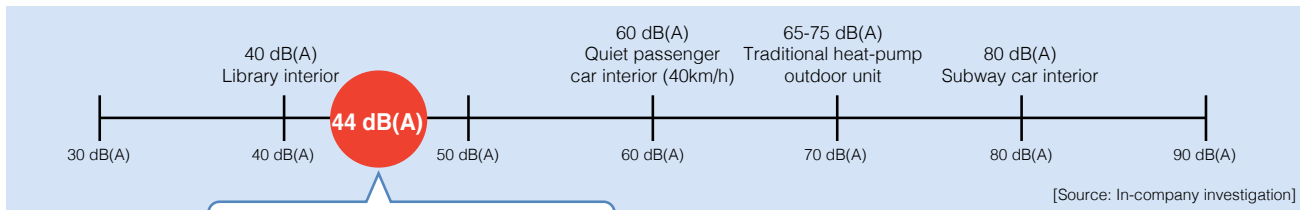

### Energy saving

Not only do all capacities meet standard requirements, but they also are ENERGY STAR® certified\*, with top level efficiency.

\*With PLA-A12/18/24/36 indoor unit.

All units are inverter-driven, operating efficiently in accordance to the cooling/heating load.

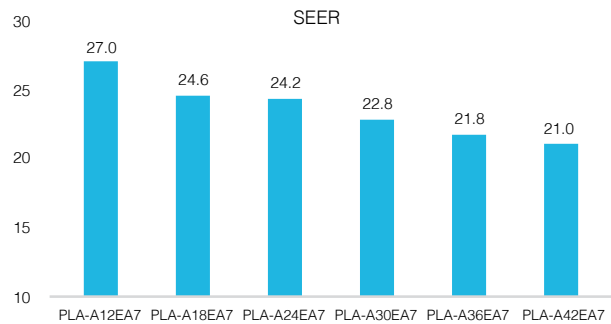

## Wide Operation Range

Due to the wide operation range, the units can be used in many different climates.

### Cooling

115° F to 0° F\*1 (46° C to -18.8° C)

### Heating

70° F to -4° F (19° C to -20° C)\*2

\*1 In case that the air protection guide wind baffle is installed. (In case the wind baffle is not installed, the minimum temperature will be 23° F (-5° C) DB)  
\*2 A24/30/36/42

## Flexible Installation

### Long piping length

The long piping length allows them to be installed in unnoticeable places such as rooftops.

	Piping	
	Length (ft)	Height (ft)
PUZ-A12NKA7	100	100
PUZ-A18NKA7	100	100
PUZ-A24NHA7	165	100
PUZ-A30NHA7	165	100
PUZ-A36NKA7	165	100
PUZ-A42NKA7	165	100

### Various types of indoor units

With various types of indoor units, there is a perfect match for any type of application, starting from residential homes to restaurants and offices.



# PRO-HEAT PUZ-HA Model



## Improved Heating Performance

Our unique Flash Injection circuit achieves remarkably high heating performance. This technology has resulted in an excellent heating capacity rating in outdoor temperatures as low as 5° F, and the guaranteed heating operation range of the heating mode has been extended to -13° F. Accordingly, the hyper-heating PUZ-HA Model are perfect for warming homes in the coldest of regions.

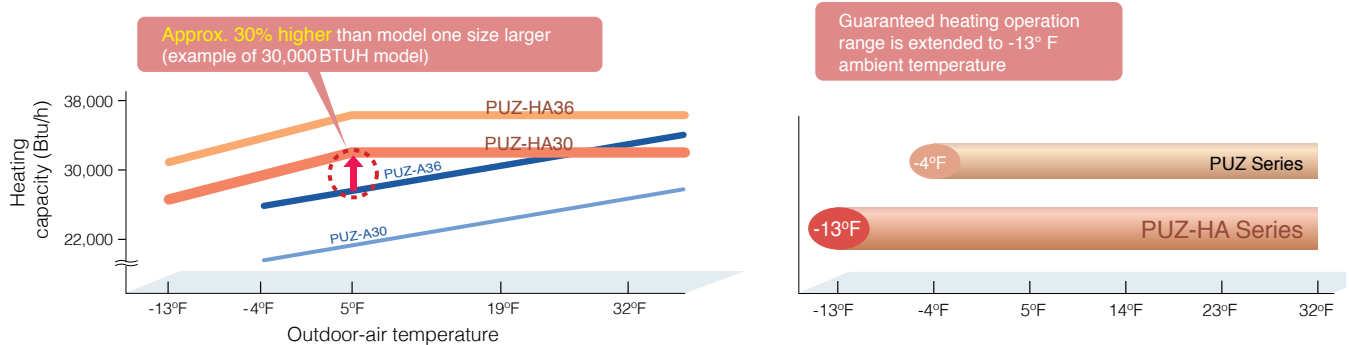

## Enhanced Comfort

The Flash Injection circuit improves start-up and recover from the defrosting operation. A newly introduced defrost operation control also improves defrost frequency. These features enable the temperature to reach the set temperature more quickly, and contribute to maintaining it at the desired setting.

### Quick Start-up

■ Operation at 36° F outdoor temperature

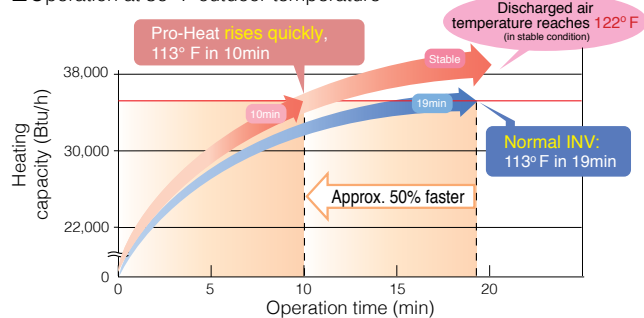

■ Operation at -4° F outdoor temperature

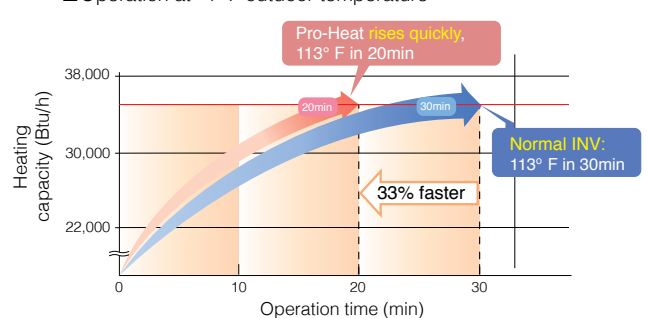

### Pro-Heat Defrost Control and Faster Recovery from Defrost Operation Field Test Results: Office building in Asahikawa, Hokkaido, Japan

■ Operation data for 25 Jan. 2005

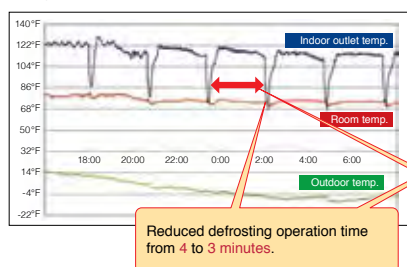

■ Operation data for 2 Dec. 2004

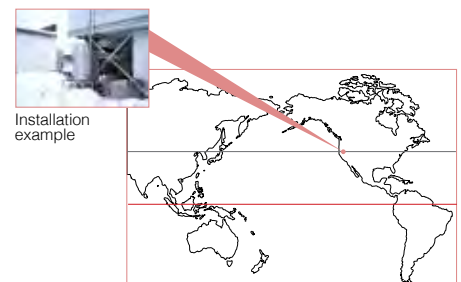
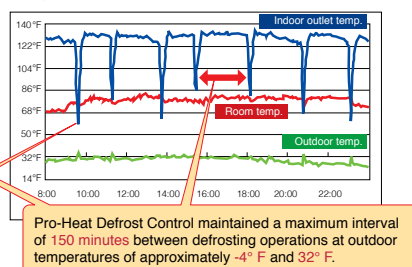

# PLA Model

A complete line-up that offer superior energy savings. The incorporation of wide air-outlet and the 3D i-see Sensor® enhances airflow distribution control, achieving an enhanced level of comfort throughout the room. The synergy of higher energy efficiency and more comfortable room environment results in the utmost user satisfaction.



## 4-way Ceiling Cassette Line-up

For users seeking further energy savings, we offer a wide line-up from 12-42 KBTU/H.

### Line-up

Model	12	18	24	30	36	42
Series						
4-way Cassette (PLA-A)	PLA-A12EA7	PLA-A18EA7	PLA-A24EA7	PLA-A30EA7	PLA-A36EA7	PLA-A42EA7

### Key Technologies for Higher Energy Efficiency

#### 3D Turbo Fan

By optimizing the fan blade wing design using a three-dimensional shape, efficiency has been improved and operating noise reduced.

### Indoor/Outdoor Unit Combinations



4-way Cassette  
PLA-A EA

#### Power Inverter



PUY/PUZ-A12/18

PUY/PUZ-A24/30

PUY/PUZ-A36/42

PUY-HA24

PUZ-HA30/36

PUZ-HA42

## Energy-saving Performance

SEER/HSPF has been greatly improved, realizing industry-leading energy-saving features.

### SEER

■ PLA-BA Series ■ PLA-EA Series

### HSPF

■ PLA-BA Series ■ PLA-EA Series

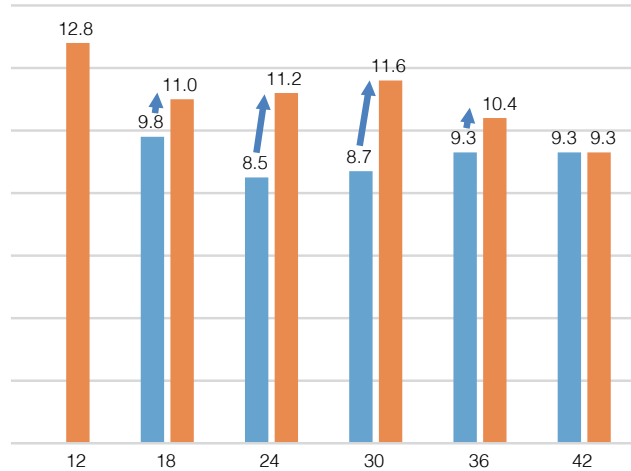
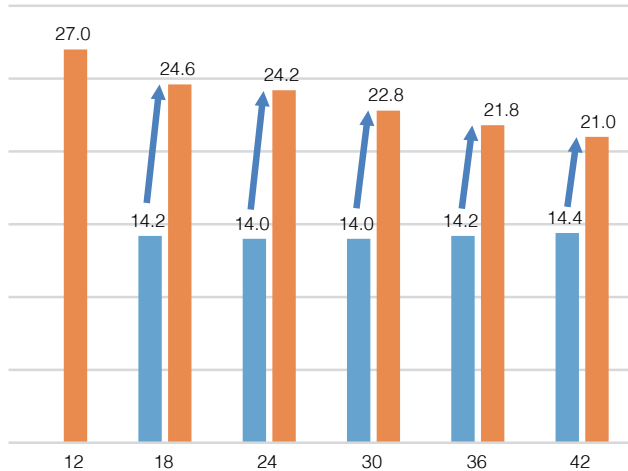



## Horizontal Airflow

For users seeking further energy savings, we offer a wide line-up from 12-42 KBTU/H.

### Draft reduction vane setting

The newly function Draft Reduction of manual vane setting makes the air flow direction more horizontal than usual horizontal vane setting. It reduces a drafty feeling dramatically.

\*The draft reduction can be set for only 1 vane. TAR-40MAAU is required for this setting.

### Individual vane settings

**72 patterns of airflow to accommodate any room layout are available.** The number of outlet can be set to 4, 3, or 2. Flexible airflow is available by fixing the up-down airflow direction of the outlet with a wired remote controller (or manually).

### 72 airflow patterns



#### 4-, 3-, or 2- way outlet selection\*

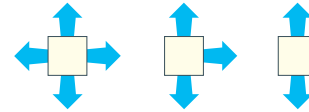

\*Optional parts air outlet shutter plate is required for 2- or 3- way outlet selection.



#### Setting the air direction for each outlet with wired remote controller

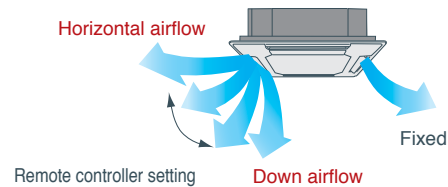

## Easy Installation

### Electrical box wiring

After reviewing the power supply terminal position in the electrical box, the structure was redesigned to improve connectivity. This has made previously complex wiring work easier.

■ Previous Model (BA Model)



■ New Model (EA Model)



### Increased space for piping work

The top and bottom positions of the liquid and gas pipes have been reversed to allow the gas pipe work, which requires more effort, to be completed first. Further, through structural innovations related to the space around the pipes, the area where the spanner can be moved has been increased, thus improving liquid pipe work and enabling it to be completed smoothly.

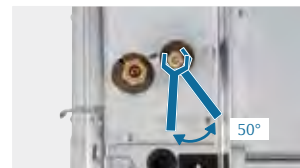

### Temporary hanging hook

The structure of the panel has been revised and is now equipped with a temporary hanging hook. This has improved work efficiency during panel installation.



### No need to remove screws

Installation is possible without removing the screws for the corner panel and the control box, simply loosen them. This lowers the risk of losing screws.

■ Corner panel



■ Corner box cover



### Lightweight decorative panel

After reviewing the structure and materials, weight has been reduced approximately 20% compared to the previous model, reducing the burden of installation.



## Detects number of people

The 3D i-see Sensor\* detects the number of people in the room and adjusts the power accordingly. This makes automatic power-saving operation possible in places where the number of people changes frequently. Additionally, when the area is continuously unoccupied, the system switches to a more enhanced power-saving mode. Depending on the setting, it can also stop the operation.

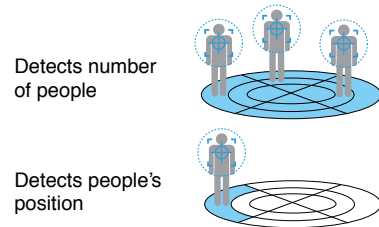
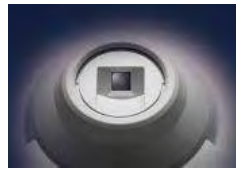

## Detects people's position

Once a person is detected, the angle of the vane is automatically adjusted. Each vane can be independently set to Direct Airflow or Indirect Airflow according to taste.

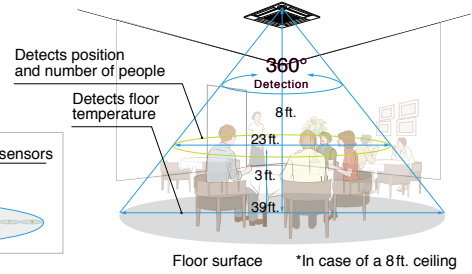
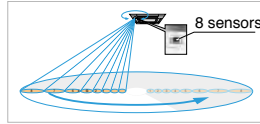

## Detects number of people

## Room occupancy energy-saving mode

The 3D i-see Sensor detects the number of people in the room. It then calculates the occupancy rate based on the maximum number of people in the room up to that point in time in order to save air conditioning power. When the occupancy rate is approximately 30%, air-conditioning power equivalent to 2° F during both cooling and heating operation is saved. The temperature is controlled according to the number of people.

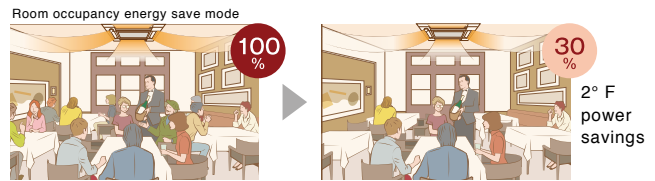

## No occupancy energy-saving mode

When 3D i-see Sensor detects that no one is in the room, the system is switched to a pre-set power-saving mode. If the room remains unoccupied for more than 60min, air-conditioning power equivalent to 4° F during both cooling and heating operation is saved. This contributes to preventing waste in terms of heating and cooling.

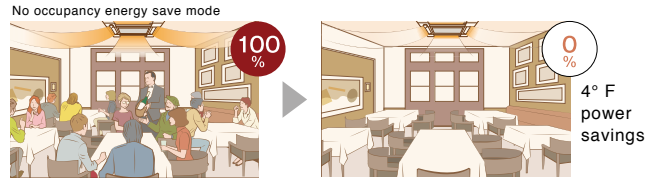

## No occupancy Auto-OFF mode

When the room remains unoccupied for a pre-set period of time, the air conditioner turns off automatically, thereby providing even greater power savings. The time until operation is stopped can be set in intervals of 10 min, ranging from 60 to 180 min.

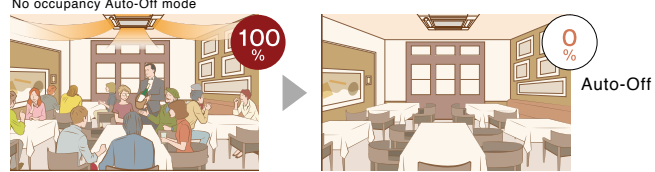

\*TAR-40MAAU is required for each setting

## Detects people's position

### Direct/Indirect settings\*

The horizontal airflow spreads across the ceiling. When set to Indirect Airflow uncomfortable drafty-feeling is eliminated completely.

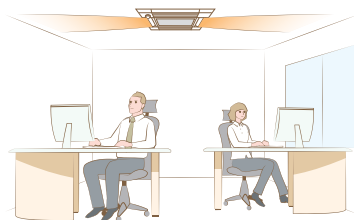

\*TAR-40MAAU is required for each setting.

### Seasonal airflow\*

#### When Cooling

Saves energy while keeping a comfortable effective temperature by automatically switching between ventilation and cooling. When a pre-set temperature is reached, the air conditioning unit switches to swing fan operation to maintain the effective temperature. This clever function contributes to keeping a comfortable coolness.

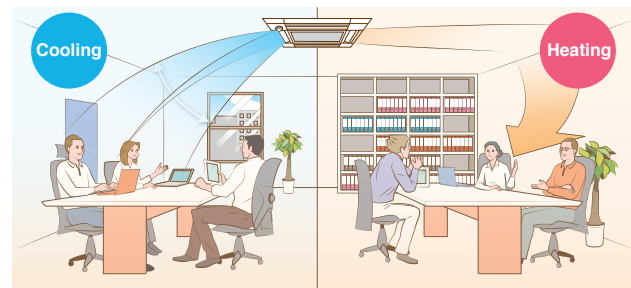

\*TAR-40MAAU is required for each setting.

#### When Heating

The air conditioning unit automatically switches between circulator and heating. Wasted heat that accumulates near the ceiling is reused via circulation. When a pre-set temperature is reached the air conditioner switches from heating to circulator and blows air in the horizontal direction. It pushes down the warm air that has gathered near the ceiling to people's height, thereby providing smart heating.

# PLA-A Model



## MODEL SELECTION

### Indoor Unit



PLA-A12/18/24/30/36/42EA7



Required grille: PLP-40EAEU / PLP-41EAEU

### Outdoor Unit

#### Cooling Only



PUY-A12/18NKA7



PUY-A24/30NHA7



PUY-A36/42NKA7

#### Heat Pump



PUZ-A12/18NKA7



PUZ-A24/30NHA7



PUZ-A36/42NKA7

#### Hyper-heating



PUZ-HA24NHA



PUZ-HA30/36NHA5



PUZ-HA42NKA

### Remote Controller



\*optional  
TAR-40MAAU



\*optional  
TAC-YT53CRAU-J



\*optional



\*optional  
TAR-CT01MAU-5B

# PLA Model

## COOLING ONLY



Indoor Unit				PLA-A12EA7	PLA-A18EA7	PLA-A24EA7	PLA-A30EA7	PLA-A36EA7	PLA-A42EA7
Outdoor Unit				PUY-A12NKA7(-BS)	PUY-A18NKA7(-BS)	PUY-A24NKA7(-BS)	PUY-A30NKA7(-BS)	PUY-A36NKA7(-BS)	PUY-A42NKA7(-BS)
Cooling	Capacity	Rated <sup>1</sup>	BTU/H	12,000	18,000	24,000	30,000	36,000	42,000
	Capacity Range	Min-Max	BTU/H	5,800-12,000	8,000-18,000	10,000-24,000	9,000-30,000	16,000-36,000	16,000-42,000
	Power Input	Rated <sup>1</sup>	W	730	1,250	1,670	2,540	2,780	3,590
	Moisture Removal	Pints/h		1.2	2.4	3.0	5.4	4.5	7.9
	Sensible Heat Factor			0.890	0.850	0.860	0.800	0.860	0.790
Heating	Capacity at 47°F	Rated	BTU/H	—	—	—	—	—	—
	Capacity Range	Min-Max	BTU/H	—	—	—	—	—	—
	Power Input at 47°F	Rated	W	—	—	—	—	—	—
	Capacity at 17°F	Rated	BTU/H	—	—	—	—	—	—
	Capacity at 5°F	Max	BTU/H	—	—	—	—	—	—
Efficiency	SEER			27.0	24.6	24.2	22.8	21.8	21.0
	EER			16.4	14.4	14.3	11.8	12.9	11.6
	HSPF			—	—	—	—	—	—
	COP			—	—	—	—	—	—
	ENERGY STAR <sup>®</sup> Certified			Yes	Yes	Yes	No	Yes	No
Indoor Unit	Air Flow Rate - Cooling (Quiet-Lo-Med-Hi-SHI)	Dry	CFM	420-460-490-530	420-460-570-600	530-640-710-810	570-670-780-880	670-850-1020-1200	740-920-1060-1200
		Wet	CFM	380-420-450-490	380-420-530-560	490-600-670-770	530-630-740-840	630-810-980-1160	700-880-1020-1160
	Air Flow Rate - Heating (Quiet-Lo-Med-Hi-SHI)	Dry	CFM	420-460-490-530	420-460-570-600	530-640-710-810	570-670-780-880	670-850-1020-1200	740-920-1060-1200
	Sound Pressure Level (Quiet-Lo-Med-Hi-SHI)	Cooling	dB(A)	27-28-29-30	28-29-31-32	28-30-33-36	28-32-35-38	32-37-41-44	34-38-42-45
		Heating	dB(A)	27-28-29-30	28-29-31-32	28-30-33-36	28-32-35-38	32-37-41-44	34-38-42-45
	External Static Pressure		In. W.G.	—	—	—	—	—	—
	Condensate Lift Mechanism	Max Distance	In. [mm]	[849]	[849]	[849]	[849]	[849]	[849]
	Dimensions	H	In. [mm]	10-5/32 // 1-9/16 [258 // 40]	10-5/32 // 1-9/16 [258 // 40]	10-5/32 // 1-9/16 [258 // 40]	11-3/4 // 1-9/16 [298 // 40]	11-3/4 // 1-9/16 [298 // 40]	11-3/4 // 1-9/16 [298 // 40]
		W	In. [mm]	33-1/16 // 37-13/32 [840]	33-1/16 // 37-13/32 [840]	33-1/16 // 37-13/32 [840]	33-1/16 // 37-13/32 [840]	33-1/16 // 37-13/32 [840]	33-1/16 // 37-13/32 [840]
		D	In. [mm]	33-1/16 // 37-13/32 [840]	33-1/16 // 37-13/32 [840]	33-1/16 // 37-13/32 [840]	33-1/16 // 37-13/32 [840]	33-1/16 // 37-13/32 [840]	33-1/16 // 37-13/32 [840]
Weight	lbs [kg]		46 // 11 [21 // 5]	46 // 11 [21 // 5]	56 // 11 [25 // 5]	56 // 11 [25 // 5]	56 // 11 [25 // 5]	56 // 11 [25 // 5]	
Outdoor Unit	MCA	A		11.0	11.0	19.0	19.0	25.0	25.0
	MOC	A		28	28	26	26	31	31
	Dimensions	H	In. [mm]	24-13/16 [630]	24-13/16 [630]	37-1/8 [943]	37-1/8 [943]	52-11/16 [1338]	52-11/16 [1338]
		W	In. [mm]	31-13/16 (+7/16) [809 (+62)]	31-13/16 (+7/16) [809 (+62)]	37-13/32 [950]	37-13/32 [950]	41-5/16 [1050]	41-5/16 [1050]
		D	In. [mm]	11-3/16 [300]	11-3/16 [300]	13 (+1-3/16) [330 (+30)]	13 (+1-3/16) [330 (+30)]	13 (+1-3/16) [330 (+30)]	13 (+1-3/16) [330 (+30)]
	Weight	lbs [kg]		92 [41]	99 [44]	151 [68]	151 [68]	211 [96]	211 [96]
	Air Flow Rate (Cooling/Heating)	CFM		1590/—	1590/—	1940/—	1940/—	3880/—	3880/—
	Sound Pressure Level	Cooling	dB(A)	44	44	47	47	52	52
Heating		dB(A)	—	—	—	—	—	—	
Piping	Diameter	Gas (O.D.)	In. [mm]	1/2 [12.7]	1/2 [12.7]	5/8 [15.88]	5/8 [15.88]	5/8 [15.88]	5/8 [15.88]
		Liquid (O.D.)	In. [mm]	1/4 [6.35]	1/4 [6.35]	3/8 [9.52]	3/8 [9.52]	3/8 [9.52]	3/8 [9.52]
		Indoor Drain	In. [mm]	—	—	—	—	—	—
Max. Length	ft [m]		165 [50]	165 [50]	225 [68]	225 [68]	225 [68]	225 [68]	
Max. Height	ft [m]		100 [30]	100 [30]	100 [30]	100 [30]	100 [30]	100 [30]	
Electrical	Outdoor-Indoor <sup>5</sup>	V, ph, Hz		208/230, 1, 60	208/230, 1, 60	208/230, 1, 60	208/230, 1, 60	208/230, 1, 60	208/230, 1, 60
	Recommended Breaker Size	A		15	15	25	25	30	30
Refrigerant Type				R410A	R410A	R410A	R410A	R410A	R410A
Guaranteed Temperature Operation Range	Cooling <sup>6</sup>	°F DB [°C DB]		-40.0 to 115.0 [-40.0 to 46.0]	-40.0 to 115.0 [-40.0 to 46.0]	-40.0 to 115.0 [-40.0 to 46.0]	-40.0 to 115.0 [-40.0 to 46.0]	-40.0 to 115.0 [-40.0 to 46.0]	-40.0 to 115.0 [-40.0 to 46.0]
	Heating	°F DB [°C DB]		—	—	—	—	—	—

Notes:  
 AHRI Rated Conditions <sup>1</sup>Cooling (Indoor // Outdoor) <sup>°F</sup> 80 DB, 67 WB // 95 DB, 75 WB  
 (Rated data is determined at a fixed compressor speed)

<sup>5</sup>Indoor units receive power from outdoor units through field-supplied interconnected wiring.

<sup>6</sup>Wind baffles required to operate below 23°F DB in cooling mode. PUY with wind baffle: -40°F - 115°F. Refer to wind baffle documentation for further information.

### SEACOAST PROTECTION

- External Outer Panel: Phosphate coating + Acrylic-Enamel coating
- Fan Motor Support: Epoxy resin coating (at edge face)
- Separator Assembly; Valve Bed: Epoxy resin coating (at edge face)
- "Blue Fin" treatment is an anti-corrosion treatment that is applied to the condenser coil to protect it against airborne contaminants.

# PLA Model

## HEAT PUMP



Indoor Unit				PLA-A12EA7	PLA-A18EA7	PLA-A24EA7	PLA-A30EA7	PLA-A36EA7	PLA-A42EA7
Outdoor Unit				PUZ-A12NKA7(-BS)	PUZ-A18NKA7(-BS)	PUZ-A24NKA7(-BS)	PUZ-A30NKA7(-BS)	PUZ-A36NKA7(-BS)	PUZ-A42NKA7(-BS)
Cooling	Capacity	Rated <sup>1</sup>	BTU/H	12,000	18,000	24,000	30,000	36,000	42,000
	Capacity Range	Min-Max	BTU/H	5,800-12,000	8,000-18,000	10,000-24,000	9,000-30,000	16,000-36,000	16,000-42,000
	Power Input	Rated <sup>1</sup>	W	730	1,250	1,670	2,540	2,780	3,590
	Moisture Removal	Pints/h		1.2	2.4	3.0	5.4	4.5	7.9
	Sensible Heat Factor			0.890	0.850	0.860	0.800	0.860	0.790
Heating	Capacity at 47°F	Rated <sup>2</sup>	BTU/H	14,000	19,000	26,000	32,000	38,000	45,000
	Capacity Range	Min-Max	BTU/H	5,500-20,000	7,900-23,000	9,000-29,000	9,000-33,000	18,000-42,000	18,000-48,000
	Power Input at 47°F	Rated <sup>2</sup>	W	830	1,300	1,750	2,400	2,540	3,290
	Capacity at 17°F	Rated <sup>3</sup>	BTU/H	10,100	11,000	14,900	18,100	22,000	28,000
	Capacity at 5°F	Max <sup>4</sup>	BTU/H	—	—	—	—	—	—
Efficiency	SEER			27.0	24.6	24.2	22.8	21.8	21.0
	EER			16.4	14.4	14.3	11.8	12.9	11.6
	HSPF			12.8	11	11.2	11.6	10.4	9.3
	COP			4.94	4.28	4.35	3.9	4.38	4.0
	ENERGY STAR <sup>®</sup> Certified			Yes	Yes	Yes	No	Yes	No
Indoor Unit	Air Flow Rate - Cooling (Quiet-Lo-Med-Hi-SHI)	Dry	CFM	420-460-490-530	420-460-570-600	530-640-710-810	570-670-780-880	670-850-1020-1200	740-920-1060-1200
		Wet	CFM	380-420-450-490	380-420-530-560	490-600-670-770	530-630-740-840	630-810-980-1160	700-880-1020-1160
	Air Flow Rate - Heating (Quiet-Lo-Med-Hi-SHI)	Dry	CFM	420-460-490-530	420-460-570-600	530-640-710-810	570-670-780-880	670-850-1020-1200	740-920-1060-1200
	Sound Pressure Level (Quiet-Lo-Med-Hi-SHI)	Cooling	dB(A)	27-28-29-30	28-29-31-32	28-30-33-36	28-32-35-38	32-37-41-44	34-38-42-45
		Heating	dB(A)	27-28-29-30	28-29-31-32	28-30-33-36	28-32-35-38	32-37-41-44	34-38-42-45
	External Static Pressure	In. W.G.		—	—	—	—	—	—
	Condensate Lift Mechanism	Max Distance	In. [mm]	[849]	[849]	[849]	[849]	[849]	[849]
	Dimensions	H	In. [mm]	10-5/32 // 1-9/16 [258 // 40]	10-5/32 // 1-9/16 [258 // 40]	10-5/32 // 1-9/16 [258 // 40]	11-3/4 // 1-9/16 [298 // 40]	11-3/4 // 1-9/16 [298 // 40]	11-3/4 // 1-9/16 [298 // 40]
		W	In. [mm]	33-1/16 // 37-13/32 [840]	33-1/16 // 37-13/32 [840]	33-1/16 // 37-13/32 [840]	33-1/16 // 37-13/32 [840]	33-1/16 // 37-13/32 [840]	33-1/16 // 37-13/32 [840]
		D	In. [mm]	33-1/16 // 37-13/32 [840]	33-1/16 // 37-13/32 [840]	33-1/16 // 37-13/32 [840]	33-1/16 // 37-13/32 [840]	33-1/16 // 37-13/32 [840]	33-1/16 // 37-13/32 [840]
Weight	lbs [kg]		46 // 11 [21 // 5]	46 // 11 [21 // 5]	56 // 11 [25 // 5]	56 // 11 [25 // 5]	56 // 11 [25 // 5]	56 // 11 [25 // 5]	
Outdoor Unit	MCA	A		11.0	11.0	19.0	19.0	25.0	25.0
	MOC	A		28	28	26	26	31	31
	Dimensions	H	In. [mm]	24-13/16 [630]	24-13/16 [630]	37-1/8 [943]	37-1/8 [943]	52-11/16 [1338]	52-11/16 [1338]
		W	In. [mm]	31-13/16 (+7/16) [809 (+62)]	31-13/16 (+7/16) [809 (+62)]	37-13/32 [950]	37-13/32 [950]	41-5/16 [1050]	41-5/16 [1050]
		D	In. [mm]	11-3/16 [300]	11-3/16 [300]	13 (+1-3/16) [330 (+30)]	13 (+1-3/16) [330 (+30)]	13 (+1-3/16) [330 (+30)]	13 (+1-3/16) [330 (+30)]
	Weight	lbs [kg]		93 [42]	100 [45]	153 [69]	153 [69]	214 [97]	214 [97]
	Air Flow Rate (Cooling/Heating)	CFM		1590/1590	1590/1590	1940/1940	1940/1940	3880/3880	3880/3880
	Sound Pressure Level	Cooling	dB(A)	44	44	47	47	52	52
Heating		dB(A)	46	46	48	48	53	53	
Piping	Diameter	Gas (O.D.)	In. [mm]	1/2 [12.7]	1/2 [12.7]	5/8 [15.88]	5/8 [15.88]	5/8 [15.88]	5/8 [15.88]
		Liquid (O.D.)	In. [mm]	1/4 [6.35]	1/4 [6.35]	3/8 [9.52]	3/8 [9.52]	3/8 [9.52]	3/8 [9.52]
		Indoor Drain	In. [mm]	—	—	—	—	—	—
Max. Length	ft [m]		100 [30]	100 [30]	165 [50]	165 [50]	165 [50]	165 [50]	
Max. Height	ft [m]		100 [30]	100 [30]	100 [30]	100 [30]	100 [30]	100 [30]	
Electrical	Outdoor-Indoor <sup>5</sup>	V, ph, Hz		208/230, 1, 60	208/230, 1, 60	208/230, 1, 60	208/230, 1, 60	208/230, 1, 60	208/230, 1, 60
	Recommended Breaker Size	A		15	15	25	25	30	30
Refrigerant Type				R410A	R410A	R410A	R410A	R410A	R410A
Guaranteed Temperature Operation Range	Cooling <sup>6</sup>	°F DB [°C DB]		0.0 to 115.0 [-18.0 to 46.0]	0.0 to 115.0 [-18.0 to 46.0]	0.0 to 115.0 [-18.0 to 46.0]	0.0 to 115.0 [-18.0 to 46.0]	0.0 to 115.0 [-18.0 to 46.0]	0.0 to 115.0 [-18.0 to 46.0]
	Heating	°F DB [°C DB]		12.0 to 70.0 [-11.0 to 21.0]	12.0 to 70.0 [-11.0 to 21.0]	-4.0 to 70.0 [-20.0 to 21.0]	-4.0 to 70.0 [-20.0 to 21.0]	-4.0 to 70.0 [-20.0 to 21.0]	-4.0 to 70.0 [-20.0 to 21.0]

Notes:  
 AHRI Rated Conditions <sup>1</sup>Cooling (Indoor // Outdoor) °F 80 DB, 67 WB // 95 DB, 75 WB  
 (Rated data is determined at a fixed compressor speed) <sup>2</sup>Heating at 47°F (Indoor // Outdoor) °F 70 DB, 60 WB // 47 DB, 43 WB  
<sup>3</sup>Heating at 17°F (Indoor // Outdoor) °F 70 DB, 60 WB // 17 DB, 15 WB  
<sup>4</sup>Heating at 5°F (Indoor // Outdoor) °F 70 DB, 60 WB // 5 DB, 4 WB  
<sup>5</sup>Indoor units receive power from outdoor units through field-supplied interconnected wiring.  
<sup>6</sup>Wind baffles required to operate below 23°F DB in cooling mode. PUZ with wind baffle: 0° F - 115° F. Refer to wind baffle documentation for further information.  
 SEACOAST PROTECTION  
 • External Outer Panel: Phosphate coating + Acrylic-Enamel coating  
 • Fan Motor Support: Epoxy resin coating (at edge face)  
 • Separator Assembly; Valve Bed: Epoxy resin coating (at edge face)  
 • "Blue Fin" treatment is an anti-corrosion treatment that is applied to the condenser coil to protect it against airborne contaminants.

# PLA Model

## HYPER-HEATING



Indoor Unit				PLA-A24EA7	PLA-A30EA7	PLA-A36EA7	PLA-A42EA7
Outdoor Unit				PUZ-HA24NHA	PUZ-HA30NHA5	PUZ-HA36NHA5	PUZ-HA42NKA
Cooling	Capacity	Rated <sup>1</sup>	BTU/H	24,000	30,000	36,000	42,000
	Capacity Range	Min-Max	BTU/H	10,000-24,000	18,000	18,000	19,000
	Power Input	Rated <sup>1</sup>	W	1,710	2,400	2,850	4,160
	Moisture Removal	Pints/h		3.0	7.2	7.1	10.9
	Sensible Heat Factor			0.860	0.730	0.710	0.710
Heating	Capacity at 47°F	Rated <sup>2</sup>	BTU/H	26,000	32,000	38,000	48,000
	Capacity Range	Min-Max	BTU/H	10,000-28,000	18,000-34,000	18,000-40,000	21,000-54,000
	Power Input at 47°F	Rated <sup>2</sup>	W	1,700	3,330	3,130	4,560
	Capacity at 17°F	Rated <sup>3</sup>	BTU/H	17,300	19,000	28,000	44,000
	Capacity at 5°F	Max <sup>4</sup>	BTU/H	26,000	32,000	38,000	48,000
Efficiency	SEER			21.5	15.6	17.0	14.8
	EER			14.0	12.5	12.6	10.1
	HSPF			12	9.4	10	10
	COP			4.31	2.72	3.44	3.02
	ENERGY STAR <sup>®</sup> Certified			Yes	Yes	Yes	No
Indoor Unit	Air Flow Rate - Cooling (Quiet-Lo-Med-Hi-SHi)	Dry	CFM	530-640-710-810	570-670-780-880	670-850-1020-1200	740-920-1060-1200
		Wet	CFM	490-600-670-770	530-630-740-840	630-810-980-1160	700-880-1020-1160
	Air Flow Rate - Heating (Quiet-Lo-Med-Hi-SHi)	Dry	CFM	530-640-710-810	570-670-780-880	670-850-1020-1200	740-920-1060-1200
	Sound Pressure Level (Quiet-Lo-Med-Hi-SHi)	Cooling	dB(A)	28-30-33-36	28-32-35-38	32-37-41-44	34-38-42-45
		Heating	dB(A)	28-30-33-36	28-32-35-38	32-37-41-44	34-38-42-45
	External Static Pressure		In. W.G.	—	—	—	—
	Condensate Lift Mechanism	Max Distance	In. [mm]	[849]	[849]	[849]	[849]
	Dimensions	H	In. [mm]	10-5/32 // 1-9/16 [258 // 40]	11-3/4 // 1-9/16 [298 // 40]	11-3/4 // 1-9/16 [298 // 40]	11-3/4 // 1-9/16 [298 // 40]
		W	In. [mm]	33-1/16 // 37-13/32 [840]	33-1/16 // 37-13/32 [840]	33-1/16 // 37-13/32 [840]	33-1/16 // 37-13/32 [840]
		D	In. [mm]	33-1/16 // 37-13/32 [840]	33-1/16 // 37-13/32 [840]	33-1/16 // 37-13/32 [840]	33-1/16 // 37-13/32 [840]
Weight	lbs [kg]		56 // 11 [25 // 5]	56 // 11 [25 // 5]	56 // 11 [25 // 5]	56 // 11 [25 // 5]	
Outdoor Unit	MCA	A		19.0	28.0	28.0	37.0
	MOCP	A		26	40	40	44
	Dimensions	H	In. [mm]	37-1/8 [943]	53-1/8 [1375]	53-1/8 [1375]	52-11/16 [1338]
		W	In. [mm]	37-13/32 [950]	37-3/8 [950]	37-3/8 [950]	41-3/8 [1051]
		D	In. [mm]	13 [+1-3/16] [330 [+30]]	13 [+1-3/16] [330 [+30]]	13 [+1-3/16] [330 [+30]]	13 [+1-3/16] [330 [+30]]
	Weight	lbs [kg]		85 [188]	265 [120]	265 [120]	287 [130]
	Air Flow Rate (Cooling/Heating)	CFM		1940/1940	3530/3530	3530/3530	3320/3320
	Sound Pressure Level	Cooling	dB(A)	52	52	52	49
Heating		dB(A)	53	53	53	51	
Piping	Diameter	Gas (O.D.)	In. [mm]	5/8 [15.88]	5/8 [15.88]	5/8 [15.88]	5/8 [15.88]
		Liquid (O.D.)	In. [mm]	3/8 [9.52]	3/8 [9.52]	3/8 [9.52]	3/8 [9.52]
		Indoor Drain	In. [mm]	—	—	—	—
	Max. Length	ft [m]		165 [50]	245 [75]	245 [75]	245 [75]
Max. Height	ft [m]		100 [30]	100 [30]	100 [30]	100 [30]	
Electrical	Outdoor-Indoor <sup>5</sup>	V, ph, Hz		208/230, 1, 60	208/230, 1, 60	208/230, 1, 60	208/230, 1, 60
	Recommended Breaker Size	A		25	30	30	40
Refrigerant Type				R410A	R410A	R410A	R410A
Guaranteed Temperature Operation Range	Cooling <sup>6</sup>	°F DB [°C DB]		0.0 to 115.0 [-18.0 to 46.0]	0.0 to 115.0 [-18.0 to 46.0]	0.0 to 115.0 [-18.0 to 46.0]	0.0 to 115.0 [-18.0 to 46.0]
	Heating	°F DB [°C DB]		-13.0 to 70.0 [-25.0 to 21.0]	-13.0 to 70.0 [-25.0 to 21.0]	-13.0 to 70.0 [-25.0 to 21.0]	-13.0 to 70.0 [-25.0 to 21.0]

Notes:  
 AHRI Rated Conditions <sup>1</sup>Cooling (Indoor // Outdoor) °F 80 DB, 67 WB // 95 DB, 75 WB  
 (Rated data is determined at a fixed compressor speed) <sup>2</sup>Heating at 47°F (Indoor // Outdoor) °F 70 DB, 60 WB // 47 DB, 43 WB  
 Conditions <sup>3</sup>Heating at 17°F (Indoor // Outdoor) °F 70 DB, 60 WB // 17 DB, 15 WB  
<sup>4</sup>Heating at 5°F (Indoor // Outdoor) °F 70 DB, 60 WB // 5 DB, 4 WB  
<sup>5</sup>Indoor units receive power from outdoor units through field-supplied interconnected wiring.  
<sup>6</sup>Wind baffles required to operate below 23°F DB in cooling mode. PUZ with wind baffle: 0° F - 115° F.





# PKA Model

The compact, wall-mounted indoor units offer the convenience of simple installation, and a large product line-up (A12-A36 models) ensures a best-match solution. Designed for highly efficient energy savings, the PKA Model is the answer to your air conditioning needs.



## Flat Panel & Pure White Finish

A flat panel design and pure white color that harmonizes with virtually any interior.



PKA-A HA7



PKA-A KA7



## Compact Indoor Units

Indoor unit width has been reduced by as much as 20-1/16" (A36KA7). Units take up much less space, greatly increasing installation possibilities.

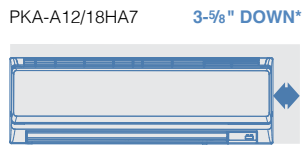

\*Compared to PKA-A12/18GA

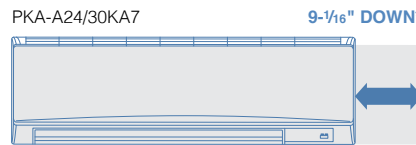

\*Compared to PKA-A24/30FA

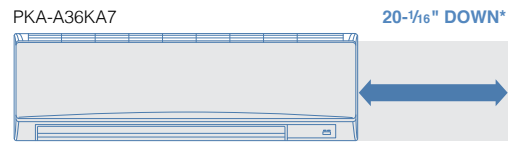

\*Compared to PKA-A36FA

## Energy Saving Performance

SEER/HSPF has been greatly improved, realizing industry-leading energy-saving features.

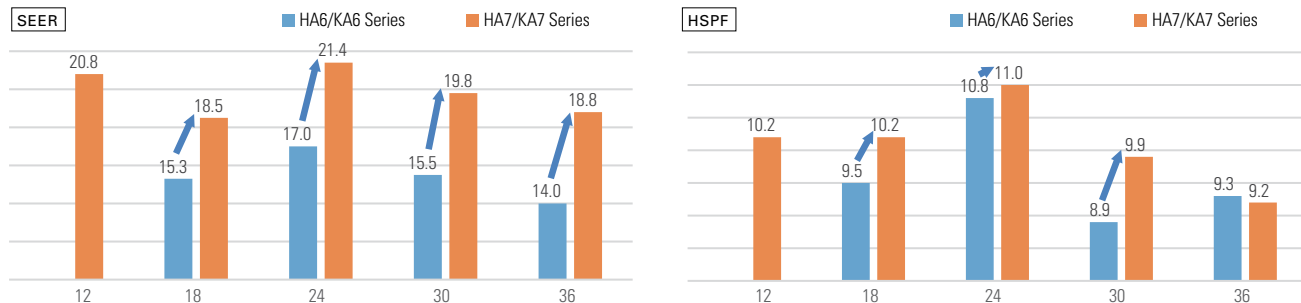

# PKA Model



## MODEL SELECTION

### Indoor Unit

PKA-A12/18HA7



PKA-A24/30/36KA7



### Outdoor Unit

#### Cooling Only



PUY-A12/18NKA7



PUY-A24/30NHA7

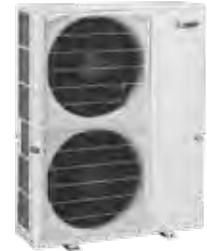

PUY-A36/42NKA7

#### Heat Pump



PUZ-A12/18NKA7



PUZ-A24/30NHA7

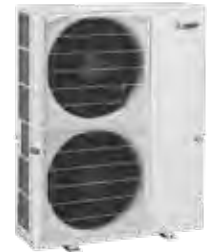

PUZ-A36/42NKA7

#### Hyper-heating



PUZ-HA24NHA



PUZ-HA30/36NHA5

### Remote Controller



\*optional  
TAR-40MAAU



\*optional  
TAC-YT53CRAU-J

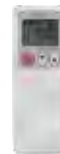

\*optional



\*optional  
TAR-CT01MAU-SB

# PKA Model

## COOLING ONLY



Indoor Unit				PKA-A12HA7	PKA-A18HA7	PKA-A24KA7	PKA-A30KA7	PKA-A36KA7
Outdoor Unit				PUY-A12NKA7(-BS)	PUY-A18NKA7(-BS)	PUY-A24NHA7(-BS)	PUY-A30NHA7(-BS)	PUY-A36NKA7(-BS)
Cooling	Capacity	Rated <sup>1</sup>	BTU/H	12,000	18,000	24,000	30,000	36,000
	Capacity Range	Min-Max	BTU/H	5,800-12,000	8,000-18,000	10,000-24,000	9,000-30,000	16,000-36,000
	Power Input	Rated <sup>1</sup>	W	1,000	1,820	1,960	3,150	3,330
	Moisture Removal	Pints/h		2.0	5.2	5.0	8.1	9.7
	Sensible Heat Factor			0.810	0.680	0.770	0.700	0.700
Heating	Capacity at 47°F	Rated	BTU/H	—	—	—	—	—
	Capacity Range	Min-Max	BTU/H	—	—	—	—	—
	Power Input at 47°F	Rated	W	—	—	—	—	—
	Capacity at 17°F	Rated	BTU/H	—	—	—	—	—
	Capacity at 5°F	Max	BTU/H	—	—	—	—	—
Efficiency	SEER			20.8	18.5	21.4	19.8	18.8
	EER			12.0	9.9	12.2	9.5	10.8
	HSPF			—	—	—	—	—
	COP			—	—	—	—	—
	ENERGY STAR <sup>®</sup> Certified			No	No	No	No	No
Indoor Unit	Air Flow Rate - Cooling (Quiet-Lo-Med-Hi-SHi)	Dry	CFM	320-370-425	320-370-425	635-705-775	635-705-775	705-810-920
		Wet	CFM	290-335-380	290-335-380	570-635-700	570-635-700	635-730-830
	Air Flow Rate - Heating (Quiet-Lo-Med-Hi-SHi)	Dry	CFM	320-370-425	320-370-425	635-705-775	635-705-775	705-810-920
	Sound Pressure Level (Quiet-Lo-Med-Hi-SHi)	Cooling	dB(A)	36-40-43	36-40-43	39-42-45	39-42-45	43-46-49
		Heating	dB(A)	36-40-43	36-40-43	39-42-45	39-42-45	43-46-49
	External Static Pressure		In. W.G.	—	—	—	—	—
	Condensate Lift Mechanism	Max Distance	In. [mm]	—	—	—	—	—
		H	In. [mm]	11-5/8 [295]	11-5/8 [295]	14-3/8 [365]	14-3/8 [365]	14-3/8 [365]
	Dimensions	W	In. [mm]	35-3/8 [898]	35-3/8 [898]	46-1/16 [1170]	46-1/16 [1170]	46-1/16 [1170]
		D	In. [mm]	9-13/16 [249]	9-13/16 [249]	11-5/8 [295]	11-5/8 [295]	11-5/8 [295]
Weight	lbs [kg]		29 [13]	29 [13]	46 [21]	46 [21]	46 [21]	
Outdoor Unit	MCA	A		11.0	11.0	19.0	19.0	25.0
	MOCP	A		28	28	26	26	31
	Dimensions	H	In. [mm]	24-13/16 [630]	24-13/16 [630]	37-1/8 [943]	37-1/8 [943]	52-11/16 [1338]
		W	In. [mm]	31-13/16 (+7/16) [809 (+62)]	31-13/16 (+7/16) [809 (+62)]	37-13/32 [950]	37-13/32 [950]	41-5/16 [1050]
		D	In. [mm]	11-3/16 [300]	11-3/16 [300]	13 (+1-3/16) [330 (+30)]	13 (+1-3/16) [330 (+30)]	13 (+1-3/16) [330 (+30)]
	Weight	lbs [kg]		92 [41]	99 [44]	151 [68]	151 [68]	211 [96]
	Air Flow Rate (Cooling/Heating)	CFM		1590/—	1590/—	1940/—	1940/—	3880/—
Sound Pressure Level	Cooling	dB(A)	44	44	47	47	52	
	Heating	dB(A)	—	—	—	—	—	
Piping	Diameter	Gas (O.D.)	In. [mm]	1/2 [12.7]	1/2 [12.7]	5/8 [15.88]	5/8 [15.88]	5/8 [15.88]
		Liquid (O.D)	In. [mm]	1/4 [6.35]	1/4 [6.35]	3/8 [9.52]	3/8 [9.52]	3/8 [9.52]
		Indoor Drain	In. [mm]	5/8 [16]	5/8 [16]	5/8 [16]	5/8 [16]	5/8 [16]
	Max. Length	ft [m]		165 [50]	165 [50]	225 [68]	225 [68]	225 [68]
	Max. Height	ft [m]		100 [30]	100 [30]	100 [30]	100 [30]	100 [30]
Electrical	Outdoor-Indoor <sup>5</sup>	V, ph, Hz		208/230, 1, 60	208/230, 1, 60	208/230, 1, 60	208/230, 1, 60	208/230, 1, 60
	Recommended Breaker Size	A		15	15	25	25	30
Refrigerant Type				R410A	R410A	R410A	R410A	R410A
Guaranteed Temperature Operation Range	Cooling <sup>6</sup>	°F DB [°C DB]		-40.0 to 115.0 [-40.0 to 46.0]	-40.0 to 115.0 [-40.0 to 46.0]	-40.0 to 115.0 [-40.0 to 46.0]	-40.0 to 115.0 [-40.0 to 46.0]	-40.0 to 115.0 [-40.0 to 46.0]
	Heating	°F DB [°C DB]		—	—	—	—	—

Notes:  
 AHRI Rated Conditions <sup>1</sup>Cooling (Indoor // Outdoor) <sup>2</sup>F 80 DB, 67 WB // 95 DB, 75 WB

(Rated data is determined at a fixed compressor speed)

<sup>3</sup>Indoor units receive power from outdoor units through field-supplied interconnected wiring.

<sup>4</sup>Wind baffles required to operate below 23°F DB in cooling mode. PUY with wind baffle: -40°F - 115°F. Refer to wind baffle documentation for further information.

### SEACOAST PROTECTION

- External Outer Panel: Phosphate coating + Acrylic-Enamel coating
- Fan Motor Support: Epoxy resin coating (at edge face)
- Separator Assembly; Valve Bed: Epoxy resin coating (at edge face)
- "Blue Fin" treatment is an anti-corrosion treatment that is applied to the condenser coil to protect it against airborne contaminants.

# PKA Model

## HEAT PUMP



Indoor Unit				PKA-A12HA7	PKA-A18HA7	PKA-A24KA7	PKA-A30KA7	PKA-A36KA7
Outdoor Unit				PUZ-A12NKA7(-BS)	PUZ-A18NKA7(-BS)	PUZ-A24NKA7(-BS)	PUZ-A30NKA7(-BS)	PUZ-A36NKA7(-BS)
Cooling	Capacity	Rated <sup>1</sup>	BTU/H	12,000	18,000	24,000	30,000	36,000
	Capacity Range	Min-Max	BTU/H	5,800-12,000	8,000-18,000	10,000-24,000	9,000-30,000	16,000-36,000
	Power Input	Rated <sup>1</sup>	W	1,000	1,820	1,960	3,150	3,330
	Moisture Removal	Pints/h		2.0	5.2	5.0	8.1	9.7
	Sensible Heat Factor			0.810	0.680	0.770	0.700	0.700
Heating	Capacity at 47°F	Rated <sup>2</sup>	BTU/H	14,000	19,000	26,000	32,000	38,000
	Capacity Range	Min-Max	BTU/H	5,500-18,000	7,700-22,000	9,000-28,000	8,900-34,000	18,200-40,000
	Power Input at 47°F	Rated <sup>2</sup>	W	950	1,300	1,750	2,460	2,460
	Capacity at 17°F	Rated <sup>3</sup>	BTU/H	9,200	11,300	15,700	18,300	22,400
		Max	BTU/H	11,100	13,900	18,300	21,000	25,900
Efficiency	SEER			20.8	18.5	21.4	19.8	18.8
	EER			12.0	9.9	12.2	9.5	10.8
	HSPF			10.2	10.2	11	9.9	9.2
	COP			4.31	4.28	4.35	3.81	4.52
	ENERGY STAR <sup>®</sup> Certified			No	No	No	No	No
Indoor Unit	Air Flow Rate - Cooling (Quiet-Lo-Med-Hi-SHI)	Dry	CFM	320-370-425	320-370-425	635-705-775	635-705-775	705-810-920
		Wet	CFM	290-335-380	290-335-380	570-635-700	570-635-700	635-730-830
	Air Flow Rate - Heating (Quiet-Lo-Med-Hi-SHI)	Dry	CFM	320-370-425	320-370-425	635-705-775	635-705-775	705-810-920
		Heating	dB(A)	36-40-43	36-40-43	39-42-45	39-42-45	43-46-49
	Sound Pressure Level (Quiet-Lo-Med-Hi-SHI)	Cooling	dB(A)	36-40-43	36-40-43	39-42-45	39-42-45	43-46-49
		Heating	dB(A)	36-40-43	36-40-43	39-42-45	39-42-45	43-46-49
	External Static Pressure		In. W.G.	—	—	—	—	—
	Condensate Lift Mechanism	Max Distance	In. [mm]	—	—	—	—	—
	Dimensions	H	In. [mm]	11-5/8 [295]	11-5/8 [295]	14-3/8 [365]	14-3/8 [365]	14-3/8 [365]
W		In. [mm]	35-3/8 [898]	35-3/8 [898]	46-1/16 [1170]	46-1/16 [1170]	46-1/16 [1170]	
D		In. [mm]	9-13/16 [249]	9-13/16 [249]	11-5/8 [295]	11-5/8 [295]	11-5/8 [295]	
Weight	lbs [kg]		29 [13]	29 [13]	46 [21]	46 [21]	46 [21]	
Outdoor Unit	MCA	A		11.0	11.0	19.0	19.0	25.0
	MOCP	A		28	28	26	26	31
	Dimensions	H	In. [mm]	24-13/16 [630]	24-13/16 [630]	37-1/8 [943]	37-1/8 [943]	52-11/16 [1338]
		W	In. [mm]	31-13/16 (+7/16) [809 (+62)]	31-13/16 (+7/16) [809 (+62)]	37-13/32 [950]	37-13/32 [950]	41-5/16 [1050]
		D	In. [mm]	11-3/16 [300]	11-3/16 [300]	13 (+1-3/16) [330 (+30)]	13 (+1-3/16) [330 (+30)]	13 (+1-3/16) [330 (+30)]
	Weight	lbs [kg]		93 [42]	100 [45]	153 [69]	153 [69]	214 [97]
	Air Flow Rate (Cooling/Heating)	CFM		1590/1590	1590/1590	1940/1940	1940/1940	3880/3880
Sound Pressure Level	Cooling	dB(A)	44	44	47	47	52	
	Heating	dB(A)	46	46	48	48	53	
Piping	Diameter	Gas (O.D.)	In. [mm]	1/2 [12.7]	1/2 [12.7]	5/8 [15.88]	5/8 [15.88]	5/8 [15.88]
		Liquid (O.D.)	In. [mm]	1/4 [6.35]	1/4 [6.35]	3/8 [9.52]	3/8 [9.52]	3/8 [9.52]
		Indoor Drain	In. [mm]	5/8 [16]	5/8 [16]	5/8 [16]	5/8 [16]	5/8 [16]
	Max. Length	ft [m]		100 [30]	100 [30]	165 [50]	165 [50]	165 [50]
	Max. Height	ft [m]		100 [30]	100 [30]	100 [30]	100 [30]	100 [30]
Electrical	Outdoor-Indoor <sup>5</sup>	V, ph, Hz		208/230, 1, 60	208/230, 1, 60	208/230, 1, 60	208/230, 1, 60	208/230, 1, 60
	Recommended Breaker Size	A		15	15	25	25	30
Refrigerant Type				R410A	R410A	R410A	R410A	R410A
Guaranteed Temperature Operation Range	Cooling <sup>6</sup>	°F DB [°C DB]		0.0 to 115.0 [-18.0 to 46.0]	0.0 to 115.0 [-18.0 to 46.0]	0.0 to 115.0 [-18.0 to 46.0]	0.0 to 115.0 [-18.0 to 46.0]	0.0 to 115.0 [-18.0 to 46.0]
	Heating	°F DB [°C DB]		12.0 to 70.0 [-11.0 to 21.0]	12.0 to 70.0 [-11.0 to 21.0]	-4.0 to 70.0 [-20.0 to 21.0]	-4.0 to 70.0 [-20.0 to 21.0]	-4.0 to 70.0 [-20.0 to 21.0]

Notes:

- AHRI Rated Conditions <sup>1</sup>Cooling (Indoor // Outdoor) °F 80 DB, 67 WB // 95 DB, 75 WB
- (Rated data is determined at a fixed compressor speed) <sup>2</sup>Heating at 47°F (Indoor // Outdoor) °F 70 DB, 60 WB // 47 DB, 43 WB
- <sup>3</sup>Heating at 17°F (Indoor // Outdoor) °F 70 DB, 60 WB // 17 DB, 15 WB
- Conditions <sup>4</sup>Heating at 5°F (Indoor // Outdoor) °F 70 DB, 60 WB // 5 DB, 4 WB

<sup>5</sup>Indoor units receive power from outdoor units through field-supplied interconnected wiring.

<sup>6</sup>Wind baffles required to operate below 23°F DB in cooling mode. PUZ with wind baffle: 0° F - 115° F. Refer to wind baffle documentation for further information.

SEACOAST PROTECTION

- External Outer Panel: Phosphate coating + Acrylic-Enamel coating
- Fan Motor Support: Epoxy resin coating (at edge face)
- Separator Assembly, Valve Bed: Epoxy resin coating (at edge face)
- "Blue Fin" treatment is an anti-corrosion treatment that is applied to the condenser coil to protect it against airborne contaminants.

# PKA Model

## HYPER-HEATING



Indoor Unit				PKA-A24KA7	PKA-A30KA7	PKA-A36KA7
Outdoor Unit				PUZ-HA24NHA	PUZ-HA30NHA5	PUZ-HA36NHA5
Cooling	Capacity	Rated <sup>1</sup>	BTU/H	24,000	30,000	33,400
	Capacity Range	Min-Max	BTU/H	10,000-24,000	18,000	18,000
	Power Input	Rated <sup>1</sup>	W	1,900	2,500	2,790
	Moisture Removal	Pints/h		5.0	8.1	8.7
	Sensible Heat Factor			0.770	0.700	0.710
Heating	Capacity at 47°F	Rated <sup>2</sup>	BTU/H	26,000	32,000	38,000
	Capacity Range	Min-Max	BTU/H	10,000-28,000	18,000-34,000	18,000-40,000
	Power Input at 47°F	Rated <sup>2</sup>	W	1,920	2,930	3,410
	Capacity at 17°F	Rated <sup>3</sup>	BTU/H	17,200	19,000	25,000
	Capacity at 5°F	Max <sup>4</sup>	BTU/H	26,000	32,000	38,000
Efficiency	SEER			19.5	16.5	16.2
	EER			12.6	12.0	12.0
	HSPF			11.2	9.5	10
	COP			3.8	3.2	3.26
	ENERGY STAR <sup>®</sup> Certified			Yes	No	No
Indoor Unit	Air Flow Rate - Cooling (Quiet-Lo-Med-Hi-SHi)	Dry	CFM	635-705-775	635-705-775	705-810-920
		Wet	CFM	570-635-700	570-635-700	635-730-830
	Air Flow Rate - Heating (Quiet-Lo-Med-Hi-SHi)	Dry	CFM	635-705-775	635-705-775	705-810-920
	Sound Pressure Level (Quiet-Lo-Med-Hi-SHi)	Cooling	dB(A)	39-42-45	39-42-45	43-46-49
		Heating	dB(A)	39-42-45	39-42-45	43-46-49
	External Static Pressure		In. W.G.	—	—	—
	Condensate Lift Mechanism	Max Distance	In. [mm]	—	—	—
	Dimensions	H	In. [mm]	14-3/8 [365]	14-3/8 [365]	14-3/8 [365]
		W	In. [mm]	46-1/16 [1170]	46-1/16 [1170]	46-1/16 [1170]
		D	In. [mm]	11-5/8 [295]	11-5/8 [295]	11-5/8 [295]
Weight	lbs [kg]		46 [21]	46 [21]	46 [21]	
Outdoor Unit	MCA	A		19.0	28.0	28.0
	MOCP	A		26	40	40
	Dimensions	H	In. [mm]	37-1/8 [943]	53-1/8 [1375]	53-1/8 [1375]
		W	In. [mm]	37-13/32 [950]	37-3/8 [950]	37-3/8 [950]
		D	In. [mm]	13 [+1-3/16] [330 [+30]]	13 [+1-3/16] [330 [+30]]	13 [+1-3/16] [330 [+30]]
	Weight	lbs [kg]		85 [188]	265 [120]	265 [120]
	Air Flow Rate (Cooling/Heating)	CFM		1940/1940	3530/3530	3530/3530
Sound Pressure Level	Cooling	dB(A)	52	52	52	
	Heating	dB(A)	53	53	53	
Piping	Diameter	Gas (O.D.)	In. [mm]	5/8 [15.88]	5/8 [15.88]	5/8 [15.88]
		Liquid (O.D.)	In. [mm]	3/8 [9.52]	3/8 [9.52]	3/8 [9.52]
		Indoor Drain	In. [mm]	5/8 [16]	5/8 [16]	5/8 [16]
	Max. Length	ft [m]		165 [50]	245 [75]	245 [75]
Max. Height	ft [m]		100 [30]	100 [30]	100 [30]	
Electrical	Outdoor-Indoor <sup>5</sup>	V, ph, Hz		208/230, 1, 60	208/230, 1, 60	208/230, 1, 60
	Recommended Breaker Size	A		25	30	30
Refrigerant Type				R410A	R410A	R410A
Guaranteed Temperature Operation Range	Cooling <sup>6</sup>	°F DB [°C DB]		0.0 to 115.0 [-18.0 to 46.0]	0.0 to 115.0 [-18.0 to 46.0]	0.0 to 115.0 [-18.0 to 46.0]
	Heating	°F DB [°C DB]		-13.0 to 70.0 [-25.0 to 21.0]	-13.0 to 70.0 [-25.0 to 21.0]	-13.0 to 70.0 [-25.0 to 21.0]

Notes:  
 AHRI Rated Conditions <sup>1</sup>Cooling (Indoor // Outdoor) °F 80 DB, 67 WB // 95 DB, 75 WB  
 (Rated data is determined at a fixed compressor speed) <sup>2</sup>Heating at 47°F (Indoor // Outdoor) °F 70 DB, 60 WB // 47 DB, 43 WB  
<sup>3</sup>Heating at 17°F (Indoor // Outdoor) °F 70 DB, 60 WB // 17 DB, 15 WB  
 Conditions <sup>4</sup>Heating at 5°F (Indoor // Outdoor) °F 70 DB, 60 WB // 5 DB, 4 WB  
<sup>5</sup>Indoor units receive power from outdoor units through field-supplied interconnected wiring.  
<sup>6</sup>Wind baffles required to operate below 23°F DB in cooling mode. PUZ with wind baffle: 0° F - 115° F.





# PVA Model

The PVA air handler is truly multi-positional offering up, down, left or right airflow, making it ideal for tight and unique spaces.



## Flexibility

The PVA air handler is truly multi-positional\* offering up, down, left or right airflow, making it ideal for tight and unique spaces.



## High Energy Efficiency

The PVA Model has high SEER, and is highly energy efficient compared to outdated unitary air conditioners.

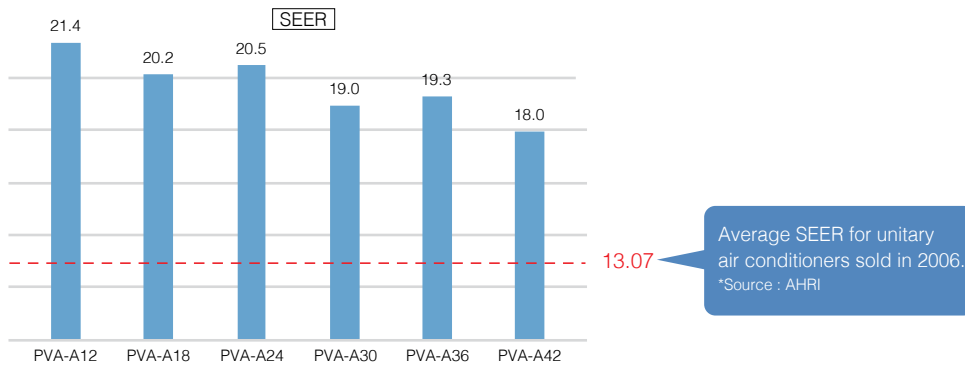

## Interlocking Function

The PVA Model has an output terminal which allows it to interlock with other appliances such as humidifiers and dehumidifiers.

## Durability

The cabinet is made of galvanized metal with a black ZAM (zinc, aluminum, magnesium) hot dip coated steel finish. The internal fan, coil, piping and circuitry are engineered and designed to work in harmony to provide years of reliable operation.

## Thermostat Control

Using the Thermostat Interface (PAC-US444CN-1), the user can replace their unitary air conditioner without changing the thermostat.



\*CMA accessory recommended for downflow applications.

# Power Inverter Model



## MODEL SELECTION

### Indoor Unit



PVA-A12/18/24/30/36/42AA7

### Outdoor Unit

#### Cooling Only



PUY-A12/18NKA7



PUY-A24/30NHA7



PUY-A36/42NKA7

#### Heat Pump



PUZ-A12/18NKA7



PUZ-A24/30NHA7



PUZ-A36/42NKA7

#### Hyper-heating



PUZ-HA24NHA



PUZ-HA30/36NHA5



PUZ-HA42NKA

### Remote Controller



\*optional  
TAR-40MAAU



\*optional  
PAC-YT52CRA



\*optional  
TAR-CT01MAU-SB

# PVA Model

## COOLING ONLY



Indoor Unit				PVA-A12AA7	PVA-A18AA7	PVA-A24AA7	PVA-A30AA7	PVA-A36AA7	PVA-A42AA7
Outdoor Unit				PUY-A12NKA7(-BS)	PUY-A18NKA7(-BS)	PUY-A24NHA7(-BS)	PUY-A30NHA7(-BS)	PUY-A36NKA7(-BS)	PUY-A42NKA7(-BS)
Cooling	Capacity	Rated <sup>1</sup>	BTU/H	12,000	18,000	24,000	30,000	36,000	42,000
	Capacity Range	Min-Max	BTU/H	4,800-12,000	7,000-18,000	10,000-24,000	10,000-30,000	14,600-36,000	15,000-42,000
	Power Input	Rated <sup>1</sup>	W	890	1,570	1,960	3,000	3,250	4,150
	Moisture Removal	Pints/h		1.2	2.4	3.0	5.4	4.5	7.9
	Sensible Heat Factor			0.770	0.760	0.830	0.740	0.770	0.810
Heating	Capacity at 47°F	Rated	BTU/H	—	—	—	—	—	—
	Capacity Range	Min-Max	BTU/H	—	—	—	—	—	—
	Power Input at 47°F	Rated	W	—	—	—	—	—	—
	Capacity at 17°F	Rated	BTU/H	—	—	—	—	—	—
	Capacity at 5°F	Max	BTU/H	—	—	—	—	—	—
Efficiency	SEER			21.4	20.2	20.5	19.0	19.3	18.0
	EER			13.4	11.4	12.2	10.0	9.8	10.1
	HSPF			—	—	—	—	—	—
	COP			—	—	—	—	—	—
	ENERGY STAR <sup>®</sup> Certified			Yes	No	No	No	No	No
Indoor Unit	Air Flow Rate - Cooling (Quiet-Lo-Med-Hi-SHi)	Dry	CFM	280-340-400	515-625-735	613-744-875	613-744-875	788-956-1125	1040-1262-1485
		Wet	CFM	—	—	—	—	—	—
	Air Flow Rate - Heating (Quiet-Lo-Med-Hi-SHi)	Dry	CFM	280-340-400	515-625-735	613-744-875	613-744-875	788-956-1125	1040-1262-1485
	Sound Pressure Level (Quiet-Lo-Med-Hi-SHi)	Cooling	dB(A)	24-28-32	28-33-36	30-34-38	30-34-38	30-34-38	34-38-42
		Heating	dB(A)	24-28-32	28-33-36	30-34-38	30-34-38	30-34-38	34-38-42
	External Static Pressure		In. W.G.	0.3-0.5-0.8	0.3-0.5-0.8	0.3-0.5-0.8	0.3-0.5-0.8	0.3-0.5-0.8	0.3-0.5-0.8
	Condensate Lift Mechanism	Max Distance	In. [mm]	—	—	—	—	—	—
		H	In. [mm]	50-1/4 [1275]	50-1/4 [1275]	54-1/4 [1378]	54-1/4 [1378]	59-1/2 [1511]	59-1/2 [1511]
	Dimensions	W	In. [mm]	17 [432]	17 [432]	21 [534]	21 [534]	25 [635]	25 [635]
		D	In. [mm]	21-5/8 [548]	21-5/8 [548]	21-5/8 [548]	21-5/8 [548]	21-5/8 [548]	21-5/8 [548]
Weight		lbs [kg]	113 [51.2]	113 [51.2]	141 [64]	141 [64]	172 [78]	172 [78]	
Outdoor Unit	MCA	A		11.0	11.0	19.0	19.0	25.0	25.0
	MOCP	A		28	28	26	26	31	31
	Dimensions	H	In. [mm]	24-13/16 [630]	24-13/16 [630]	37-1/8 [943]	37-1/8 [943]	52-11/16 [1338]	52-11/16 [1338]
		W	In. [mm]	31-13/16 (+7/16) [809 (+62)]	31-13/16 (+7/16) [809 (+62)]	37-13/32 [950]	37-13/32 [950]	41-5/16 [1050]	41-5/16 [1050]
		D	In. [mm]	11-3/16 [300]	11-3/16 [300]	13 (+1-3/16) [330 (+30)]	13 (+1-3/16) [330 (+30)]	13 (+1-3/16) [330 (+30)]	13 (+1-3/16) [330 (+30)]
	Weight		lbs [kg]	92 [41]	99 [44]	151 [68]	151 [68]	211 [96]	211 [96]
	Air Flow Rate (Cooling/Heating)		CFM	1590/—	1590/—	1940/—	1940/—	3880/—	3880/—
Sound Pressure Level	Cooling	dB(A)	44	44	47	47	52	52	
	Heating	dB(A)	—	—	—	—	—	—	
Piping	Diameter	Gas (O.D.)	In. [mm]	1/2 [12.7]	1/2 [12.7]	5/8 [15.88]	5/8 [15.88]	5/8 [15.88]	5/8 [15.88]
		Liquid (O.D)	In. [mm]	1/4 [6.35]	1/4 [6.35]	3/8 [9.52]	3/8 [9.52]	3/8 [9.52]	3/8 [9.52]
		Indoor Drain	In. [mm]	3/4 FPT [19.05]	3/4 FPT [19.05]	3/4 FPT [19.05]	3/4 FPT [19.05]	3/4 FPT [19.05]	3/4 FPT [19.05]
	Max. Length		ft [m]	165 [50]	165 [50]	225 [68]	225 [68]	225 [68]	
Max. Height		ft [m]	100 [30]	100 [30]	100 [30]	100 [30]	100 [30]		
Electrical	Outdoor-Indoor <sup>5</sup>	V, ph, Hz		208/230, 1, 60	208/230, 1, 60	208/230, 1, 60	208/230, 1, 60	208/230, 1, 60	208/230, 1, 60
	Recommended Breaker Size	A		15	15	25	25	30	30
Refrigerant Type				R410A	R410A	R410A	R410A	R410A	R410A
Guaranteed Temperature Operation Range	Cooling <sup>6</sup>	°F DB [°C DB]		-40.0 to 115.0 [-40.0 to 46.0]	-40.0 to 115.0 [-40.0 to 46.0]	-40.0 to 115.0 [-40.0 to 46.0]	-40.0 to 115.0 [-40.0 to 46.0]	-40.0 to 115.0 [-40.0 to 46.0]	-40.0 to 115.0 [-40.0 to 46.0]
	Heating	°F DB [°C DB]		—	—	—	—	—	—

Notes:

AHRI Rated Conditions  
(Rated data is determined at a fixed compressor speed)

<sup>1</sup>Cooling (Indoor // Outdoor)

<sup>6</sup>F 80 DB, 67 WB // 95 DB, 75 WB

<sup>3</sup>Indoor units receive power from outdoor units through field-supplied interconnected wiring.

<sup>4</sup>Wind baffles required to operate below 23°F DB in cooling mode. PUY with wind baffle: -40°F - 115°F. Refer to wind baffle documentation for further information.

SEACOAST PROTECTION

- External Outer Panel: Phosphate coating + Acrylic-Enamel coating
- Fan Motor Support: Epoxy resin coating (at edge face)
- Separator Assembly: Valve Bed: Epoxy resin coating (at edge face)
- "Blue Fin" treatment is an anti-corrosion treatment that is applied to the condenser coil to protect it against airborne contaminants.

# PVA Model

## HEAT PUMP



Indoor Unit			PVA-A12AA7	PVA-A18AA7	PVA-A24AA7	PVA-A30AA7	PVA-A36AA7	PVA-A42AA7	
Outdoor Unit			PUZ-A12NKA7(-BS)	PUZ-A18NKA7(-BS)	PUZ-A24NHA7(-BS)	PUZ-A30NHA7(-BS)	PUZ-A36NKA7(-BS)	PUZ-A42NKA7(-BS)	
Cooling	Capacity	Rated <sup>1</sup>	BTU/H	12,000	18,000	24,000	30,000	36,000	42,000
	Capacity Range	Min-Max	BTU/H	4,800-12,000	7,000-18,000	10,000-24,000	10,000-30,000	14,600-36,000	15,000-42,000
	Power Input	Rated <sup>1</sup>	W	890	1,570	1,960	3,000	3,250	4,150
	Moisture Removal	Pints/h		1.2	2.4	3.0	5.4	4.5	7.9
	Sensible Heat Factor			0.770	0.760	0.830	0.740	0.770	0.810
Heating	Capacity at 47°F	Rated <sup>2</sup>	BTU/H	14,000	19,000	26,000	32,000	38,000	46,000
	Capacity Range	Min-Max	BTU/H	5,700-19,000	7,700-23,000	12,000-28,000	12,000-34,000	17,700-42,000	18,100-48,000
	Power Input at 47°F	Rated <sup>2</sup>	W	1,070	1,470	1,920	2,640	3,030	3,900
	Capacity at 17°F	Rated <sup>3</sup>	BTU/H	9,900	12,000	15,000	18,000	24,000	28,400
	Capacity at 5°F	Max <sup>4</sup>	BTU/H	—	—	—	—	—	—
Efficiency	SEER			21.4	20.2	20.5	19.0	19.3	18.0
	EER			13.4	11.4	12.2	10.0	9.8	10.1
	HSPF			10.3	10.4	9.3	10	9.5	9.3
	COP			3.82	3.78	3.96	3.54	3.66	3.44
	ENERGY STAR <sup>®</sup> Certified			Yes	No	No	No	No	No
Indoor Unit	Air Flow Rate - Cooling (Quiet-Lo-Med-Hi-SHI)	Dry	CFM	280-340-400	515-625-735	613-744-875	613-744-875	788-956-1125	1040-1262-1485
		Wet	CFM	—	—	—	—	—	—
	Air Flow Rate - Heating (Quiet-Lo-Med-Hi-SHI)	Dry	CFM	280-340-400	515-625-735	613-744-875	613-744-875	788-956-1125	1040-1262-1485
	Sound Pressure Level (Quiet-Lo-Med-Hi-SHI)	Cooling	dB(A)	24-28-32	28-33-36	30-34-38	30-34-38	30-34-38	34-38-42
		Heating	dB(A)	24-28-32	28-33-36	30-34-38	30-34-38	30-34-38	34-38-42
	External Static Pressure		In. WG.	0.3-0.5-0.8	0.3-0.5-0.8	0.3-0.5-0.8	0.3-0.5-0.8	0.3-0.5-0.8	0.3-0.5-0.8
	Condensate Lift Mechanism	Max Distance	In. [mm]	—	—	—	—	—	—
	Dimensions	H	In. [mm]	50-1/4 [1275]	50-1/4 [1275]	54-1/4 [1378]	54-1/4 [1378]	59-1/2 [1511]	59-1/2 [1511]
W		In. [mm]	17 [432]	17 [432]	21 [534]	21 [534]	25 [635]	25 [635]	
D		In. [mm]	21-5/8 [548]	21-5/8 [548]	21-5/8 [548]	21-5/8 [548]	21-5/8 [548]	21-5/8 [548]	
Weight		lbs [kg]	113 [51.2]	113 [51.2]	141 [64]	141 [64]	172 [78]	172 [78]	
Outdoor Unit	MCA	A		11.0	11.0	19.0	19.0	25.0	25.0
	MOCP	A		28	28	26	26	31	31
	Dimensions	H	In. [mm]	24-13/16 [630]	24-13/16 [630]	37-1/8 [943]	37-1/8 [943]	52-11/16 [1338]	52-11/16 [1338]
		W	In. [mm]	31-13/16 (+7/16) [809 (+62)]	31-13/16 (+7/16) [809 (+62)]	37-13/32 [950]	37-13/32 [950]	41-5/16 [1050]	41-5/16 [1050]
		D	In. [mm]	11-3/16 [300]	11-3/16 [300]	13 (+1-3/16) [330 (+30)]	13 (+1-3/16) [330 (+30)]	13 (+1-3/16) [330 (+30)]	13 (+1-3/16) [330 (+30)]
	Weight		lbs [kg]	93 [42]	100 [45]	153 [69]	153 [69]	214 [97]	214 [97]
	Air Flow Rate (Cooling/Heating)		CFM	1590/1590	1590/1590	1940/1940	1940/1940	3880/3880	3880/3880
	Sound Pressure Level	Cooling	dB(A)	44	44	47	47	52	52
Heating		dB(A)	46	46	48	48	53	53	
Piping	Diameter	Gas (O.D.)	In. [mm]	1/2 [12.7]	1/2 [12.7]	5/8 [15.88]	5/8 [15.88]	5/8 [15.88]	5/8 [15.88]
		Liquid (O.D)	In. [mm]	1/4 [6.35]	1/4 [6.35]	3/8 [9.52]	3/8 [9.52]	3/8 [9.52]	3/8 [9.52]
		Indoor Drain	In. [mm]	3/4 FPT [19.05]	3/4 FPT [19.05]	3/4 FPT [19.05]	3/4 FPT [19.05]	3/4 FPT [19.05]	3/4 FPT [19.05]
	Max. Length		ft [m]	100 [30]	100 [30]	165 [50]	165 [50]	165 [50]	165 [50]
Max. Height		ft [m]	100 [30]	100 [30]	100 [30]	100 [30]	100 [30]	100 [30]	
Electrical	Outdoor-Indoor <sup>5</sup>	V, ph, Hz		208/230, 1, 60	208/230, 1, 60	208/230, 1, 60	208/230, 1, 60	208/230, 1, 60	208/230, 1, 60
	Recommended Breaker Size	A		15	15	25	25	30	30
Refrigerant Type				R410A	R410A	R410A	R410A	R410A	R410A
Guaranteed Temperature Operation Range	Cooling <sup>6</sup>	°F DB [°C DB]		0.0 to 115.0 [-18.0 to 46.0]	0.0 to 115.0 [-18.0 to 46.0]	0.0 to 115.0 [-18.0 to 46.0]	0.0 to 115.0 [-18.0 to 46.0]	0.0 to 115.0 [-18.0 to 46.0]	0.0 to 115.0 [-18.0 to 46.0]
	Heating	°F DB [°C DB]		12.0 to 70.0 [-11.0 to 21.0]	12.0 to 70.0 [-11.0 to 21.0]	-4.0 to 70.0 [-20.0 to 21.0]	-4.0 to 70.0 [-20.0 to 21.0]	-4.0 to 70.0 [-20.0 to 21.0]	-4.0 to 70.0 [-20.0 to 21.0]

Notes:

- AHRI Rated Conditions <sup>1</sup>Cooling (Indoor // Outdoor) °F 80 DB, 67 WB // 95 DB, 75 WB
- (Rated data is determined at a fixed compressor speed) <sup>2</sup>Heating at 47°F (Indoor // Outdoor) °F 70 DB, 60 WB // 47 DB, 43 WB
- Conditions <sup>3</sup>Heating at 17°F (Indoor // Outdoor) °F 70 DB, 60 WB // 17 DB, 15 WB
- <sup>4</sup>Heating at 5°F (Indoor // Outdoor) °F 70 DB, 60 WB // 5 DB, 4 WB
- <sup>5</sup>Indoor units receive power from outdoor units through field-supplied interconnected wiring.
- <sup>6</sup>Wind baffles required to operate below 23°F DB in cooling mode. PUZ with wind baffle: 0° F - 115° F. Refer to wind baffle documentation for further information.
- SEACOAST PROTECTION
  - External Outer Panel: Phosphate coating + Acrylic-Enamel coating
  - Fan Motor Support: Epoxy resin coating (at edge face)
  - Separator Assembly, Valve Bed: Epoxy resin coating (at edge face)
  - "Blue Fin" treatment is an anti-corrosion treatment that is applied to the condenser coil to protect it against airborne contaminants.

# PVA Model

## HYPER-HEATING



Indoor Unit				PVA-A24AA7	PVA-A30AA7	PVA-A36AA7	PVA-A42AA7
Outdoor Unit				PUZ-HA24NHA	PUZ-HA30NHA5	PUZ-HA36NHA5	PUZ-HA42NKA
Cooling	Capacity	Rated <sup>1</sup>	BTU/H	24,000	28,400	33,000	42,000
	Capacity Range	Min-Max	BTU/H	10,000-24,000	18,000	18,000	19,000
	Power Input	Rated <sup>1</sup>	W	2,100	2,280	2,640	4,270
	Moisture Removal	Pints/h		3.7	8.0	7.9	9.0
	Sensible Heat Factor			0.830	0.700	0.740	0.760
Heating	Capacity at 47°F	Rated <sup>2</sup>	BTU/H	26,000	32,000	38,000	48,000
	Capacity Range	Min-Max	BTU/H	10,000-28,000	18,000-34,000	18,000-40,000	18,000-54,000
	Power Input at 47°F	Rated <sup>2</sup>	W	1,980	2,590	3,040	4,010
	Capacity at 17°F	Rated <sup>3</sup>	BTU/H	17,500	22,600	29,000	42,400
	Capacity at 5°F	Max <sup>4</sup>	BTU/H	26,000	32,000	38,000	48,000
Efficiency	SEER			19.0	17.0	17.8	15.3
	EER			11.5	12.5	12.5	9.8
	HSPF			11	9.7	11	11
	COP			3.7	3.62	3.66	3.14
	ENERGY STAR <sup>®</sup> Certified			No	Yes	Yes	No
Indoor Unit	Air Flow Rate - Cooling (Quiet-Lo-Med-Hi-SHi)	Dry	CFM	613-744-875	613-744-875	788-956-1125	1040-1262-1485
		Wet	CFM	—	—	—	—
	Air Flow Rate - Heating (Quiet-Lo-Med-Hi-SHi)	Dry	CFM	613-744-875	613-744-875	788-956-1125	1040-1262-1485
		Heating	dB(A)	30-34-38	30-34-38	30-34-38	34-38-42
	Sound Pressure Level (Quiet-Lo-Med-Hi-SHi)	Cooling	dB(A)	30-34-38	30-34-38	30-34-38	34-38-42
		Heating	dB(A)	30-34-38	30-34-38	30-34-38	34-38-42
	External Static Pressure		In. W.G.	0.3-0.5-0.8	0.3-0.5-0.8	0.3-0.5-0.8	0.3-0.5-0.8
	Condensate Lift Mechanism	Max Distance	In. [mm]	—	—	—	—
			In. [mm]	54-1/4 [1378]	54-1/4 [1378]	59-1/2 [1511]	59-1/2 [1511]
Dimensions	W	In. [mm]	21 [534]	21 [534]	25 [635]	25 [635]	
	D	In. [mm]	21-5/8 [548]	21-5/8 [548]	21-5/8 [548]	21-5/8 [548]	
	Weight	lbs [kg]	141 [64]	141 [64]	172 [78]	172 [78]	
Outdoor Unit	MCA	A		19.0	28.0	28.0	37.0
	MOCP	A		26	40	40	44
	Dimensions	H	In. [mm]	37-1/8 [943]	53-1/8 [1375]	53-1/8 [1375]	52-11/16 [1338]
		W	In. [mm]	37-13/32 [950]	37-3/8 [950]	37-3/8 [950]	41-3/8 [1051]
		D	In. [mm]	13 (+1-3/16) [330 (+30)]	13 (+1-3/16) [330 (+30)]	13 (+1-3/16) [330 (+30)]	13 (+1-3/16) [330 (+30)]
	Weight	lbs [kg]		85 [188]	265 [120]	265 [120]	287 [130]
	Air Flow Rate (Cooling/Heating)	CFM		1940/1940	3530/3530	3530/3530	3320/3320
	Sound Pressure Level	Cooling	dB(A)	52	52	52	49
Heating		dB(A)	53	53	53	51	
Piping	Diameter	Gas (O.D.)	In. [mm]	5/8 [15.88]	5/8 [15.88]	5/8 [15.88]	5/8 [15.88]
		Liquid (O.D.)	In. [mm]	3/8 [9.52]	3/8 [9.52]	3/8 [9.52]	3/8 [9.52]
		Indoor Drain	In. [mm]	3/4 FPT [19.05]	3/4 FPT [19.05]	3/4 FPT [19.05]	3/4 FPT [19.05]
	Max. Length	ft [m]		165 [50]	245 [75]	245 [75]	245 [75]
Max. Height	ft [m]		100 [30]	100 [30]	100 [30]	100 [30]	
Electrical	Outdoor-Indoor <sup>5</sup>	V, ph, Hz		208/230, 1, 60	208/230, 1, 60	208/230, 1, 60	208/230, 1, 60
	Recommended Breaker Size	A		25	30	30	40
Refrigerant Type				R410A	R410A	R410A	R410A
Guaranteed Temperature Operation Range	Cooling <sup>6</sup>	°F DB [°C DB]		0.0 to 115.0 [-18.0 to 46.0]	0.0 to 115.0 [-18.0 to 46.0]	0.0 to 115.0 [-18.0 to 46.0]	0.0 to 115.0 [-18.0 to 46.0]
	Heating	°F DB [°C DB]		-13.0 to 70.0 [-25.0 to 21.0]	-13.0 to 70.0 [-25.0 to 21.0]	-13.0 to 70.0 [-25.0 to 21.0]	-13.0 to 70.0 [-25.0 to 21.0]

Notes:  
 AHRI Rated Conditions (Rated data is determined at a fixed compressor speed) <sup>1</sup>Cooling (Indoor // Outdoor) °F 80 DB, 67 WB // 95 DB, 75 WB  
<sup>2</sup>Heating at 47°F (Indoor // Outdoor) °F 70 DB, 60 WB // 47 DB, 43 WB  
<sup>3</sup>Heating at 17°F (Indoor // Outdoor) °F 70 DB, 60 WB // 17 DB, 15 WB  
 Conditions <sup>4</sup>Heating at 5°F (Indoor // Outdoor) °F 70 DB, 60 WB // 5 DB, 4 WB  
<sup>5</sup>Indoor units receive power from outdoor units through field-supplied interconnected wiring.  
<sup>6</sup>Wind baffles required to operate below 23°F DB in cooling mode. PUZ with wind baffle: 0° F - 115° F.





# PEAD Model

The thin, ceiling-concealed indoor units of this model are the perfect answer for the air conditioning needs of buildings with minimum ceiling installation space and wide-ranging external static pressure. Energy-saving efficiency has been improved, reducing electricity consumption and contributing to a further reduction in operating cost.



## Compact Indoor Units

The height is only 9-7/8" for all sizes of this model from 12 to 42 kBTU/H. This makes it possible for the unit to be installed in low ceilings with minimal clearance space.



## External Static Pressure

External static pressure conversion can be set up to five settings. Capable of being set to a maximum of 0.60 In.W.G., units are applicable to a wide range of building types.

### External static pressure

Model	12	18	24	30	36	42
PEAD-A AA	0.14-0.20-0.28-0.40-0.60 In. W.G.					

## High Energy Efficiency

SEER/HSPF has been greatly improved, and 12,000/18,000 BTU/H models have been added to the line-up.

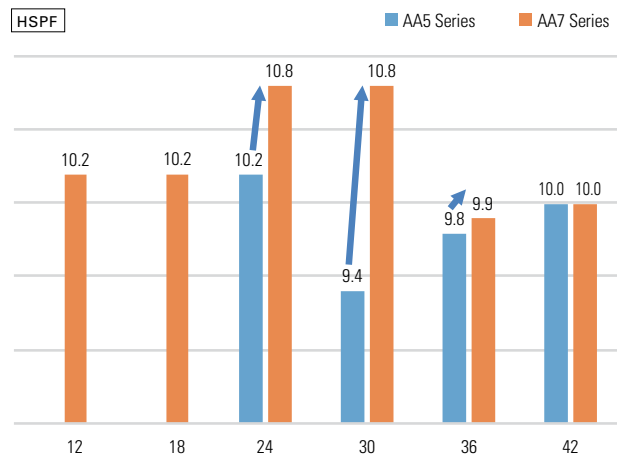
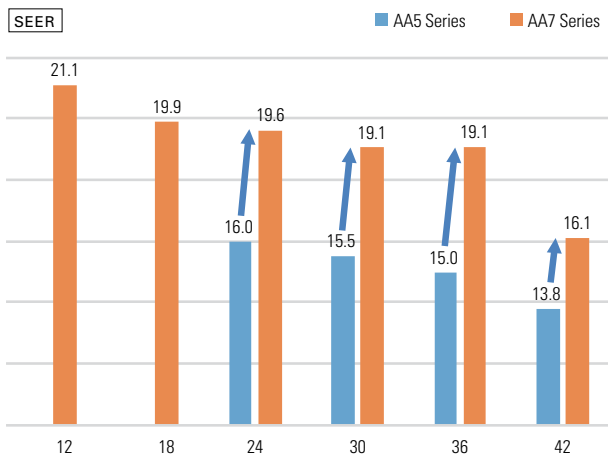

## Built-in Drain Lift Mechanism

All models feature a built-in drain lift mechanism for removal of condensate. The unit's fail-safe mechanism recognizes when there is a high liquid level in the condensate pan and turns off the indoor fan and the outdoor unit compressor to prevent overflow.

# PEAD Model



## SERIES SELECTION

### Indoor Unit

PEAD-A12/18/24/30/36/42AA7



### Outdoor Unit

#### Cooling Only



PUY-A12/18NKA7



PUY-A24/30NHA7

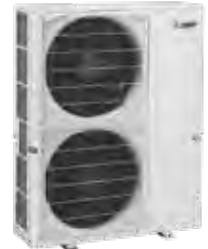

PUY-A36/42NKA7

#### Heat Pump



PUZ-A12/18NKA7



PUZ-A24/30NHA7

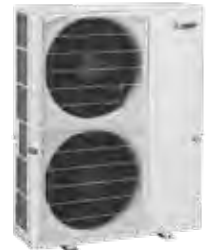

PUZ-A36/42NKA7

#### Hyper-heating



PUZ-HA24NHA



PUZ-HA30/36NHA5



PUZ-HA42NKA

### Remote Controller



\*optional  
TAR-40MAAU



\*optional  
PAC-YT52CRA



\*optional  
TAR-CT01MAU-SB



\*optional

# PEAD Model

## COOLING ONLY



Indoor Unit				PEAD-A12AA7	PEAD-A18AA7	PEAD-A24AA7	PEAD-A30AA7	PEAD-A36AA7	PEAD-A42AA7
Outdoor Unit				PUY-A12NKA7(-BS)	PUY-A18NKA7(-BS)	PUY-A24NHA7(-BS)	PUY-A30NHA7(-BS)	PUY-A36NKA7(-BS)	PUY-A42NKA7(-BS)
Cooling	Capacity	Rated <sup>1</sup>	BTU/H	12,000	18,000	24,000	30,000	36,000	42,000
	Capacity Range	Min-Max	BTU/H	5,000-12,000	8,000-18,000	10,000-24,000	9,000-30,000	16,000-36,000	16,000-42,000
	Power Input	Rated <sup>1</sup>	W	920	1,660	2,050	3,000	3,000	3,920
	Moisture Removal	Pints/h		1.8	3.7	6.9	8.6	8.1	9.0
	Sensible Heat Factor			0.830	0.770	0.680	0.680	0.750	0.760
Heating	Capacity at 47°F	Rated	BTU/H	—	—	—	—	—	—
	Capacity Range	Min-Max	BTU/H	—	—	—	—	—	—
	Power Input at 47°F	Rated	W	—	—	—	—	—	—
	Capacity at 17°F	Rated	BTU/H	—	—	—	—	—	—
	Capacity at 5°F	Max	BTU/H	—	—	—	—	—	—
Efficiency	SEER			21.1	19.9	19.6	19.1	19.1	16.1
	EER			13.0	10.8	11.7	10.0	12.0	10.7
	HSPF			—	—	—	—	—	—
	COP			—	—	—	—	—	—
	ENERGY STAR <sup>®</sup> Certified			Yes	No	No	No	No	No
Indoor Unit	Air Flow Rate - Cooling (Quiet-Lo-Med-Hi-SHi)	Dry	CFM	353-424-494	424-512-600	512-636-742	618-742-883	847-1024-1201	1042-1254-1483
		Wet	CFM	318-382-445	382-461-540	461-572-667	556-668-795	762-922-1081	1002-1214-1443
	Air Flow Rate - Heating (Quiet-Lo-Med-Hi-SHi)	Dry	CFM	353-424-494	424-512-600	512-636-742	618-742-883	847-1024-1201	1042-1254-1483
	Sound Pressure Level (Quiet-Lo-Med-Hi-SHi)	Cooling	dB(A)	28-30-34	30-33-37	30-33-37	30-34-39	33-38-42	36-40-44
		Heating	dB(A)	28-30-34	30-33-37	30-33-37	30-34-39	33-38-42	36-40-44
	External Static Pressure		In. W.G.	0.14-0.2-0.28-0.4-0.6	0.14-0.2-0.28-0.4-0.6	0.14-0.2-0.28-0.4-0.6	0.14-0.2-0.28-0.4-0.6	0.14-0.2-0.28-0.4-0.6	0.14-0.2-0.28-0.4-0.6
	Condensate Lift Mechanism	Max Distance	In. [mm]	27-9/16 [700]	27-9/16 [700]	27-9/16 [700]	27-9/16 [700]	27-9/16 [700]	27-9/16 [700]
	Dimensions	H	In. [mm]	9-7/8 [250]	9-7/8 [250]	9-7/8 [250]	9-7/8 [250]	9-7/8 [250]	9-7/8 [250]
		W	In. [mm]	35-7/16 [900]	35-7/16 [900]	43-5/16 [1100]	43-5/16 [1100]	55-1/8 [1400]	55-1/8 [1400]
		D	In. [mm]	28-7/8 [732]	28-7/8 [732]	28-7/8 [732]	28-7/8 [732]	28-7/8 [732]	28-7/8 [732]
Weight	lbs [kg]		58 [26]	62 [28]	69 [31]	69 [31]	86 [39]	91 [41]	
Outdoor Unit	MCA	A		11.0	11.0	19.0	19.0	25.0	25.0
	MOCP	A		28	28	26	26	31	31
	Dimensions	H	In. [mm]	24-13/16 [630]	24-13/16 [630]	37-1/8 [943]	37-1/8 [943]	52-11/16 [1338]	52-11/16 [1338]
		W	In. [mm]	31-13/16 (+7/16) [809 (+62)]	31-13/16 (+7/16) [809 (+62)]	37-13/32 [950]	37-13/32 [950]	41-5/16 [1050]	41-5/16 [1050]
		D	In. [mm]	11-3/16 [300]	11-3/16 [300]	13 (+1-3/16) [330 (+30)]	13 (+1-3/16) [330 (+30)]	13 (+1-3/16) [330 (+30)]	13 (+1-3/16) [330 (+30)]
	Weight	lbs [kg]		92 [41]	99 [44]	151 [68]	151 [68]	211 [96]	211 [96]
	Air Flow Rate (Cooling/Heating)	CFM		1590/—	1590/—	1940/—	1940/—	3880/—	3880/—
Sound Pressure Level	Cooling	dB(A)	44	44	47	47	52	52	
	Heating	dB(A)	—	—	—	—	—	—	
Piping	Diameter	Gas (O.D.)	In. [mm]	1/2 [12.7]	1/2 [12.7]	5/8 [15.88]	5/8 [15.88]	5/8 [15.88]	5/8 [15.88]
		Liquid (O.D)	In. [mm]	1/4 [6.35]	1/4 [6.35]	3/8 [9.52]	3/8 [9.52]	3/8 [9.52]	3/8 [9.52]
		Indoor Drain	In. [mm]	1-1/4 [32]	1-1/4 [32]	1-1/4 [32]	1-1/4 [32]	1-1/4 [32]	1-1/4 [32]
	Max. Length	ft [m]		165 [50]	165 [50]	225 [68]	225 [68]	225 [68]	
Max. Height	ft [m]		100 [30]	100 [30]	100 [30]	100 [30]	100 [30]		
Electrical	Outdoor-Indoor <sup>5</sup>	V, ph, Hz		208/230, 1, 60	208/230, 1, 60	208/230, 1, 60	208/230, 1, 60	208/230, 1, 60	208/230, 1, 60
	Recommended Breaker Size	A		15	15	25	25	30	30
Refrigerant Type				R410A	R410A	R410A	R410A	R410A	R410A
Guaranteed Temperature Operation Range	Cooling <sup>6</sup>	°F DB [°C DB]		-40.0 to 115.0 [-40.0 to 46.0]	-40.0 to 115.0 [-40.0 to 46.0]	-40.0 to 115.0 [-40.0 to 46.0]	-40.0 to 115.0 [-40.0 to 46.0]	-40.0 to 115.0 [-40.0 to 46.0]	-40.0 to 115.0 [-40.0 to 46.0]
	Heating	°F DB [°C DB]		—	—	—	—	—	—

Notes:

AHRI Rated Conditions  
(Rated data is determined at a fixed compressor speed)

<sup>1</sup>Cooling (Indoor // Outdoor)

<sup>6</sup>F 80 DB, 67 WB // 95 DB, 75 WB

<sup>3</sup>Indoor units receive power from outdoor units through field-supplied interconnected wiring.

<sup>4</sup>Wind baffles required to operate below 23°F DB in cooling mode. PUY with wind baffle: -40°F - 115°F. Refer to wind baffle documentation for further information.

SEACAST PROTECTION

- External Outer Panel: Phosphate coating + Acrylic-Enamel coating
- Fan Motor Support: Epoxy resin coating (at edge face)
- Separator Assembly: Valve Bed: Epoxy resin coating (at edge face)
- "Blue Fin" treatment is an anti-corrosion treatment that is applied to the condenser coil to protect it against airborne contaminants.



# PEAD Model

## HEAT PUMP



Indoor Unit				PEAD-A12AA7	PEAD-A18AA7	PEAD-A24AA7	PEAD-A30AA7	PEAD-A36AA7	PEAD-A42AA7
Outdoor Unit				PUZ-A12NKA7(-BS)	PUZ-A18NKA7(-BS)	PUZ-A24NKA7(-BS)	PUZ-A30NKA7(-BS)	PUZ-A36NKA7(-BS)	PUZ-A42NKA7(-BS)
Cooling	Capacity	Rated <sup>1</sup>	BTU/H	12,000	18,000	24,000	30,000	36,000	42,000
	Capacity Range	Min-Max	BTU/H	5,000-12,000	8,000-18,000	10,000-24,000	9,000-30,000	16,000-36,000	16,000-42,000
	Power Input	Rated <sup>1</sup>	W	920	1,660	2,050	3,000	3,000	3,920
	Moisture Removal	Pints/h		1.8	3.7	6.9	8.6	8.1	9.0
	Sensible Heat Factor			0.830	0.770	0.680	0.680	0.750	0.760
Heating	Capacity at 47°F	Rated <sup>2</sup>	BTU/H	14,000	19,000	26,000	32,000	38,000	45,000
	Capacity Range	Min-Max	BTU/H	5,800-18,000	7,900-22,000	9,000-28,000	8,800-34,000	18,200-40,000	18,100-48,000
	Power Input at 47°F	Rated <sup>2</sup>	W	1,030	1,400	1,750	2,490	2,410	3,290
	Capacity at 17°F	Rated <sup>3</sup>	BTU/H	8,700	11,000	14,800	18,500	20,800	30,600
		Max	BTU/H	10,500	13,500	17,200	21,200	24,200	33,700
Capacity at 5°F	Max <sup>4</sup>	BTU/H	—	—	—	—	—	—	
Efficiency	SEER			21.1	19.9	19.6	19.1	19.1	16.1
	EER			13.0	10.8	11.7	10.0	12.0	10.7
	HSPF			10.2	10.2	10.8	10.8	9.9	10
	COP			3.98	3.97	4.35	3.76	4.62	4.0
	ENERGY STAR <sup>®</sup> Certified			Yes	No	No	No	No	No
Indoor Unit	Air Flow Rate - Cooling (Quiet-Lo-Med-Hi-SHI)	Dry	CFM	353-424-494	424-512-600	512-636-742	618-742-883	847-1024-1201	1042-1254-1483
		Wet	CFM	318-382-445	382-461-540	461-572-667	556-668-795	762-922-1081	1002-1214-1443
	Air Flow Rate - Heating (Quiet-Lo-Med-Hi-SHI)	Dry	CFM	353-424-494	424-512-600	512-636-742	618-742-883	847-1024-1201	1042-1254-1483
		Heating	dB(A)	28-30-34	30-33-37	30-33-37	30-34-39	33-38-42	36-40-44
	Sound Pressure Level (Quiet-Lo-Med-Hi-SHI)	Cooling	dB(A)	28-30-34	30-33-37	30-33-37	30-34-39	33-38-42	36-40-44
		Heating	dB(A)	28-30-34	30-33-37	30-33-37	30-34-39	33-38-42	36-40-44
	External Static Pressure		In. W.G.	0.14-0.2-0.28-0.4-0.6	0.14-0.2-0.28-0.4-0.6	0.14-0.2-0.28-0.4-0.6	0.14-0.2-0.28-0.4-0.6	0.14-0.2-0.28-0.4-0.6	0.14-0.2-0.28-0.4-0.6
	Condensate Lift Mechanism	Max Distance	In. [mm]	27-9/16 [700]	27-9/16 [700]	27-9/16 [700]	27-9/16 [700]	27-9/16 [700]	27-9/16 [700]
	Dimensions	H	In. [mm]	9-7/8 [250]	9-7/8 [250]	9-7/8 [250]	9-7/8 [250]	9-7/8 [250]	9-7/8 [250]
		W	In. [mm]	35-7/16 [900]	35-7/16 [900]	43-5/16 [1100]	43-5/16 [1100]	55-1/8 [1400]	55-1/8 [1400]
D		In. [mm]	28-7/8 [732]	28-7/8 [732]	28-7/8 [732]	28-7/8 [732]	28-7/8 [732]	28-7/8 [732]	
Weight	lbs [kg]		58 [26]	62 [28]	69 [31]	69 [31]	86 [39]	91 [41]	
Outdoor Unit	MCA	A		11.0	11.0	19.0	19.0	25.0	25.0
	MOCP	A		28	28	26	26	31	31
	Dimensions	H	In. [mm]	24-13/16 [630]	24-13/16 [630]	37-1/8 [943]	37-1/8 [943]	52-11/16 [1338]	52-11/16 [1338]
		W	In. [mm]	31-13/16 (+7/16) [809 (+62)]	31-13/16 (+7/16) [809 (+62)]	37-13/32 [950]	37-13/32 [950]	41-5/16 [1050]	41-5/16 [1050]
		D	In. [mm]	11-3/16 [300]	11-3/16 [300]	13 (+1-3/16) [330 (+30)]	13 (+1-3/16) [330 (+30)]	13 (+1-3/16) [330 (+30)]	13 (+1-3/16) [330 (+30)]
	Weight	lbs [kg]		93 [42]	100 [45]	153 [69]	153 [69]	214 [97]	214 [97]
	Air Flow Rate (Cooling/Heating)	CFM		1590/1590	1590/1590	1940/1940	1940/1940	3880/3880	3880/3880
Sound Pressure Level	Cooling	dB(A)	44	44	47	47	52	52	
	Heating	dB(A)	46	46	48	48	53	53	
Piping	Diameter	Gas (O.D.)	In. [mm]	1/2 [12.7]	1/2 [12.7]	5/8 [15.88]	5/8 [15.88]	5/8 [15.88]	5/8 [15.88]
		Liquid (O.D)	In. [mm]	1/4 [6.35]	1/4 [6.35]	3/8 [9.52]	3/8 [9.52]	3/8 [9.52]	3/8 [9.52]
		Indoor Drain	In. [mm]	1-1/4 [32]	1-1/4 [32]	1-1/4 [32]	1-1/4 [32]	1-1/4 [32]	1-1/4 [32]
	Max. Length	ft [m]		100 [30]	100 [30]	165 [50]	165 [50]	165 [50]	
Max. Height	ft [m]		100 [30]	100 [30]	100 [30]	100 [30]	100 [30]		
Electrical	Outdoor-Indoor <sup>5</sup>	V, ph, Hz		208/230, 1, 60	208/230, 1, 60	208/230, 1, 60	208/230, 1, 60	208/230, 1, 60	208/230, 1, 60
	Recommended Breaker Size	A		15	15	25	25	30	30
Refrigerant Type				R410A	R410A	R410A	R410A	R410A	R410A
Guaranteed Temperature Operation Range	Cooling <sup>6</sup>	°F DB [°C DB]		0.0 to 115.0 [-18.0 to 46.0]	0.0 to 115.0 [-18.0 to 46.0]	0.0 to 115.0 [-18.0 to 46.0]	0.0 to 115.0 [-18.0 to 46.0]	0.0 to 115.0 [-18.0 to 46.0]	0.0 to 115.0 [-18.0 to 46.0]
		Heating	°F DB [°C DB]		12.0 to 70.0 [-11.0 to 21.0]	12.0 to 70.0 [-11.0 to 21.0]	-4.0 to 70.0 [-20.0 to 21.0]	-4.0 to 70.0 [-20.0 to 21.0]	-4.0 to 70.0 [-20.0 to 21.0]

Notes:

- AHRI Rated Conditions <sup>1</sup>Cooling (Indoor // Outdoor) °F 80 DB, 67 WB // 95 DB, 75 WB
- (Rated data is determined at a fixed compressor speed) <sup>2</sup>Heating at 47°F (Indoor // Outdoor) °F 70 DB, 60 WB // 47 DB, 43 WB
- Conditions <sup>3</sup>Heating at 17°F (Indoor // Outdoor) °F 70 DB, 60 WB // 17 DB, 15 WB
- <sup>4</sup>Heating at 5°F (Indoor // Outdoor) °F 70 DB, 60 WB // 5 DB, 4 WB
- <sup>5</sup>Indoor units receive power from outdoor units through field-supplied interconnected wiring.
- <sup>6</sup>Wind baffles required to operate below 23°F DB in cooling mode. PUZ with wind baffle: 0° F - 115° F. Refer to wind baffle documentation for further information.
- SEACOAST PROTECTION
  - External Outer Panel: Phosphate coating + Acrylic-Enamel coating
  - Fan Motor Support: Epoxy resin coating (at edge face)
  - Separator Assembly; Valve Bed: Epoxy resin coating (at edge face)
  - "Blue Fin" treatment is an anti-corrosion treatment that is applied to the condenser coil to protect it against airborne contaminants.

# PEAD Model

## HYPER-HEATING



Indoor Unit				PEAD-A24AA7	PEAD-A30AA7	PEAD-A36AA7	PEAD-A42AA7
Outdoor Unit				PUZ-HA24NHA	PUZ-HA30NHA5	PUZ-HA36NHA5	PUZ-HA42NKA
Cooling	Capacity	Rated <sup>1</sup>	BTU/H	24,000	27,000	33,000	42,000
	Capacity Range	Min-Max	BTU/H	10,000-24,000	18,000	18,000	19,000
	Power Input	Rated <sup>1</sup>	W	2,080	2,160	2,640	4,200
	Moisture Removal	Pints/h		6.9	8.9	7.3	9.0
	Sensible Heat Factor			0.680	0.670	0.760	0.760
Heating	Capacity at 47°F	Rated <sup>2</sup>	BTU/H	25,000	32,000	38,000	48,000
	Capacity Range	Min-Max	BTU/H	10,000-28,000	18,000-34,000	18,000-40,000	21,000-54,000
	Power Input at 47°F	Rated <sup>2</sup>	W	1,920	2,750	3,150	3,800
	Capacity at 17°F	Rated <sup>3</sup>	BTU/H	18,000	19,000	27,000	43,000
	Capacity at 5°F	Max <sup>4</sup>	BTU/H	25,000	32,000	38,000	48,000
Efficiency	SEER			16.6	16.5	16.8	14.3
	EER			11.5	12.5	12.5	10.0
	HSPF			11	9.5	10.4	10.8
	COP			3.5	3.4	3.52	3.7
	ENERGY STAR <sup>®</sup> Certified			No	Yes	Yes	No
Indoor Unit	Air Flow Rate - Cooling (Quiet-Lo-Med-Hi-SHi)	Dry	CFM	512-636-742	618-742-883	847-1024-1201	1042-1254-1483
		Wet	CFM	461-572-667	556-668-795	762-922-1081	1002-1214-1443
	Air Flow Rate - Heating (Quiet-Lo-Med-Hi-SHi)	Dry	CFM	512-636-742	618-742-883	847-1024-1201	1042-1254-1483
	Sound Pressure Level (Quiet-Lo-Med-Hi-SHi)	Cooling	dB(A)	30-33-37	30-34-39	33-38-42	36-40-44
		Heating	dB(A)	30-33-37	30-34-39	33-38-42	36-40-44
	External Static Pressure		In. W.G.	0.14-0.2-0.28-0.4-0.6	0.14-0.2-0.28-0.4-0.6	0.14-0.2-0.28-0.4-0.6	0.14-0.2-0.28-0.4-0.6
	Condensate Lift Mechanism	Max Distance	In. [mm]	27-9/16 [700]	27-9/16 [700]	27-9/16 [700]	27-9/16 [700]
	Dimensions	H	In. [mm]	9-7/8 [250]	9-7/8 [250]	9-7/8 [250]	9-7/8 [250]
		W	In. [mm]	43-5/16 [1100]	43-5/16 [1100]	55-1/8 [1400]	55-1/8 [1400]
D		In. [mm]	28-7/8 [732]	28-7/8 [732]	28-7/8 [732]	28-7/8 [732]	
Weight	lbs [kg]		69 [31]	69 [31]	86 [39]	91 [41]	
Outdoor Unit	MCA	A		19.0	28.0	28.0	37.0
	MOCP	A		26	40	40	44
	Dimensions	H	In. [mm]	37-1/8 [943]	53-1/8 [1375]	53-1/8 [1375]	52-11/16 [1338]
		W	In. [mm]	37-13/32 [950]	37-3/8 [950]	37-3/8 [950]	41-3/8 [1051]
		D	In. [mm]	13 [+1-3/16] [330 +30]	13 [+1-3/16] [330 +30]	13 [+1-3/16] [330 +30]	13 [+1-3/16] [330 +30]
	Weight	lbs [kg]		85 [188]	265 [120]	265 [120]	287 [130]
	Air Flow Rate (Cooling/Heating)	CFM		1940/1940	3530/3530	3530/3530	3320/3320
	Sound Pressure Level	Cooling	dB(A)	52	52	52	49
Heating		dB(A)	53	53	53	51	
Piping	Diameter	Gas (O.D.)	In. [mm]	5/8 [15.88]	5/8 [15.88]	5/8 [15.88]	5/8 [15.88]
		Liquid (O.D.)	In. [mm]	3/8 [9.52]	3/8 [9.52]	3/8 [9.52]	3/8 [9.52]
		Indoor Drain	In. [mm]	1-1/4 [32]	1-1/4 [32]	1-1/4 [32]	1-1/4 [32]
	Max. Length	ft [m]		165 [50]	245 [75]	245 [75]	245 [75]
Max. Height	ft [m]		100 [30]	100 [30]	100 [30]	100 [30]	
Electrical	Outdoor-Indoor <sup>5</sup>	V, ph, Hz		208/230, 1, 60	208/230, 1, 60	208/230, 1, 60	208/230, 1, 60
	Recommended Breaker Size	A		25	30	30	40
Refrigerant Type				R410A	R410A	R410A	R410A
Guaranteed Temperature Operation Range	Cooling <sup>6</sup>	°F DB [°C DB]		0.0 to 115.0 [-18.0 to 46.0]	0.0 to 115.0 [-18.0 to 46.0]	0.0 to 115.0 [-18.0 to 46.0]	0.0 to 115.0 [-18.0 to 46.0]
	Heating	°F DB [°C DB]		-13.0 to 70.0 [-25.0 to 21.0]	-13.0 to 70.0 [-25.0 to 21.0]	-13.0 to 70.0 [-25.0 to 21.0]	-13.0 to 70.0 [-25.0 to 21.0]

Notes:  
 AHRI Rated Conditions <sup>1</sup>Cooling (Indoor // Outdoor) °F 80 DB, 67 WB // 95 DB, 75 WB  
 (Rated data is determined at a fixed compressor speed) <sup>2</sup>Heating at 47°F (Indoor // Outdoor) °F 70 DB, 60 WB // 47 DB, 43 WB  
 Conditions <sup>3</sup>Heating at 17°F (Indoor // Outdoor) °F 70 DB, 60 WB // 17 DB, 15 WB  
<sup>4</sup>Heating at 5°F (Indoor // Outdoor) °F 70 DB, 60 WB // 5 DB, 4 WB  
<sup>5</sup>Indoor units receive power from outdoor units through field-supplied interconnected wiring.  
<sup>6</sup>Wind baffles required to operate below 23°F DB in cooling mode. PUZ with wind baffle: 0° F - 115° F.



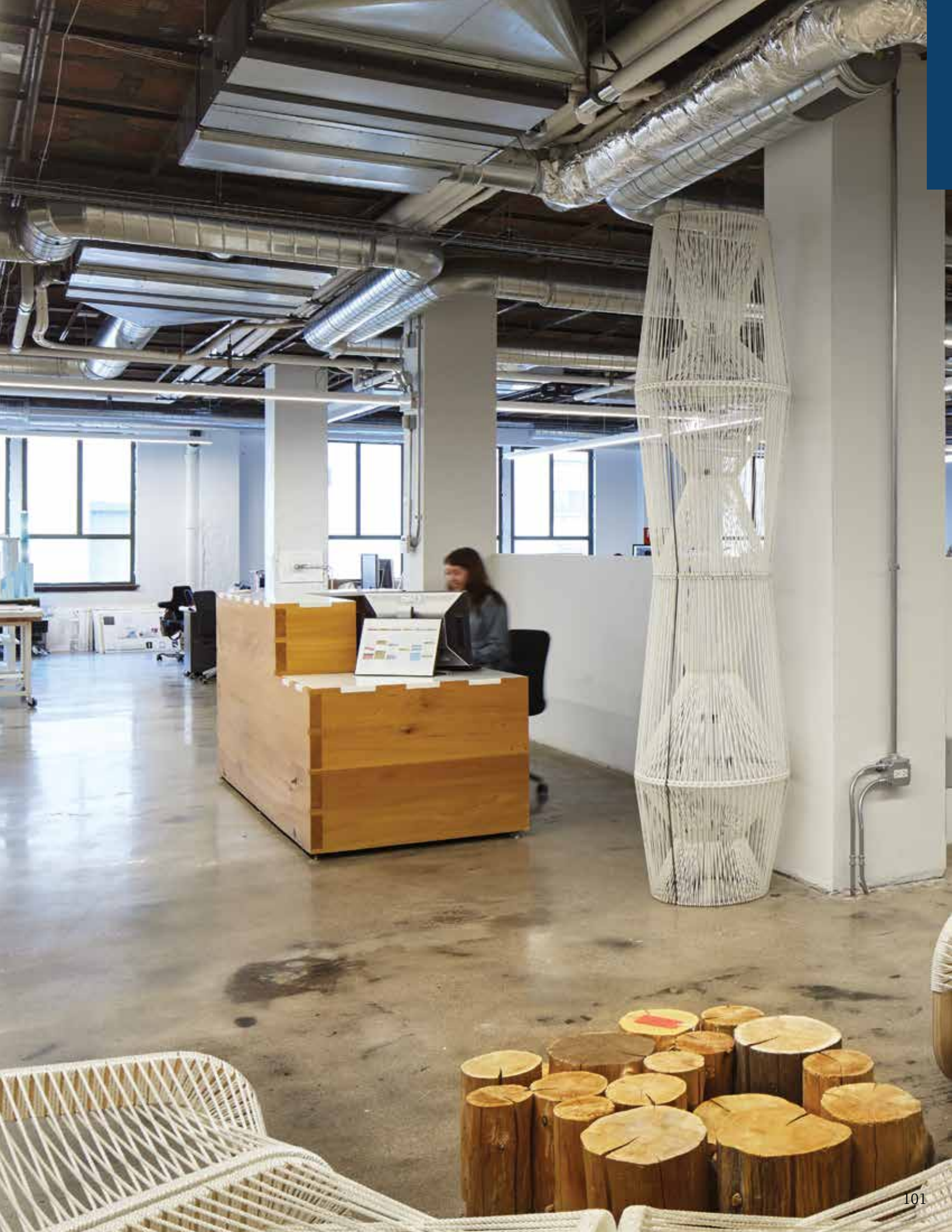

# PCA Model

A stylish new indoor unit design and airflow settings for both high and low ceiling interiors expand installation possibilities. Together with exceptional energy-saving performance, these units are the solution to diversified air conditioning needs.



## Stylish Indoor Unit Design

A stylish square-like design is adopted for the indoor units of all models. As a result, the units blend in better with the ceiling.

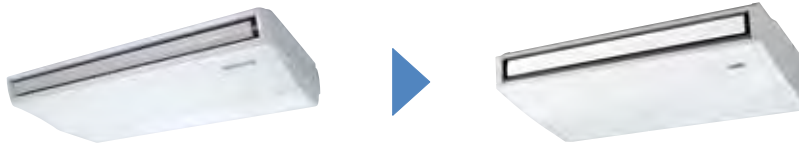

## High Energy Efficiency

SEER/HSPF has been greatly improved, realizing industry-leading energy-saving features.

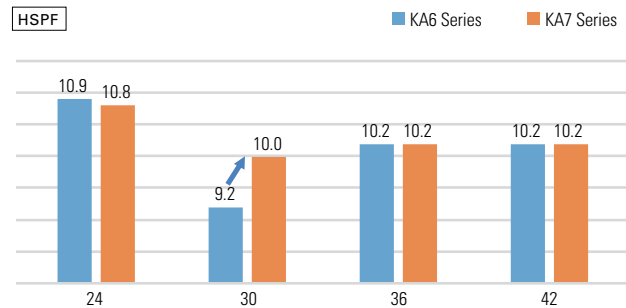
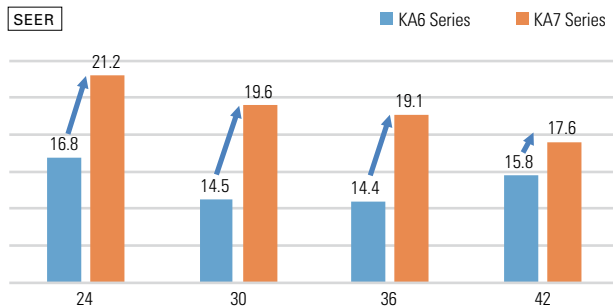

## Optional Drain Pump for All Models

The pumping height of the optional drain pump has been increased from 15-3/4" to 23-5/8", expanding flexibility in choosing unit location during installation work.

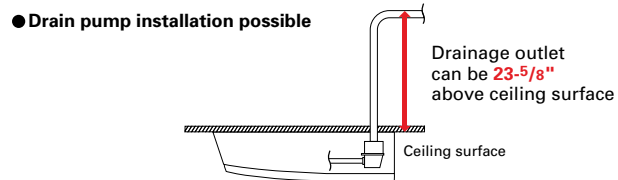

## Equipped with Automatic Air-speed Adjustment

In addition to the conventional 4-speed setting, units are now equipped with an automatic air-speed adjustment mode. This setting automatically adjusts the air-speed to conditions that match the room environment. At the start of heating/cooling operation, the airflow is set to high-speed to quickly heat/cool the room. When the room temperature reaches the desired setting, the airflow speed is decreased automatically for stable comfortable heating/cooling operation.

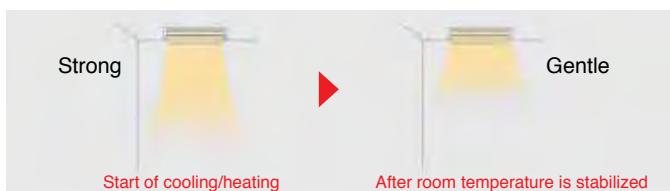

## Equipped with High/Low-ceiling Modes

Units are equipped with high- and low-ceiling operation modes that make it possible to switch the airflow volume to match room height. The ability to choose the optimum airflow volume ensures even temperature distribution throughout the room.

Capacity (kBTU/H)	High ceiling (ft)	Standard ceiling (ft)	Low ceiling (ft)
24	11.5	8.9	8.2
30	11.5	8.9	8.2
36	13.8	9.8	8.5
42	13.8	9.8	8.5

## i-see Sensor™ (Optional)

The i-see Sensor, an infrared sensor that detects floor temperature to improve the unevenness in room temperature. When cooling and heating, it also saves energy while keeping a comfortable effective temperature.

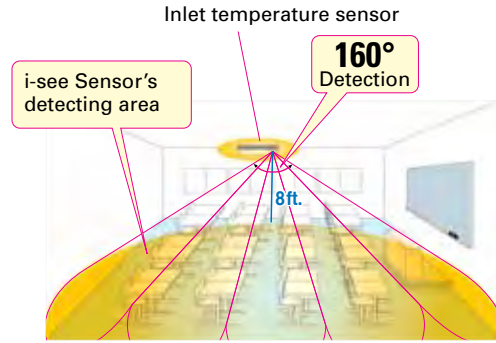

## PCA Model



MODEL SELECTION	
<p><b>Indoor Unit</b></p>  <p>PCA-A24/30/36/42KA7</p>	<p><b>Outdoor Unit</b></p> <p><b>Cooling Only</b></p> <div style="display: flex; justify-content: space-around;"> <div style="text-align: center;">  <p>PUY-A24/30NHA7</p> </div> <div style="text-align: center;">  <p>PUY-A36/42NKA7</p> </div> </div> <p><b>Heat Pump</b></p> <div style="display: flex; justify-content: space-around;"> <div style="text-align: center;">  <p>PUZ-A24/30NHA7</p> </div> <div style="text-align: center;">  <p>PUZ-A36/42NKA7</p> </div> </div> <p><b>Hyper-heating</b></p> <div style="display: flex; justify-content: space-around;"> <div style="text-align: center;">  <p>PUZ-HA24NHA</p> </div> <div style="text-align: center;">  <p>PUZ-HA30/36NHA5</p> </div> <div style="text-align: center;">  <p>PUZ-HA42NKA</p> </div> </div>
<p><b>Remote Controller</b></p>	<div style="display: flex; justify-content: space-around;"> <div style="text-align: center;">  <p>*optional TAR-40MAAU</p> </div> <div style="text-align: center;">  <p>*optional TAC-YT53CRAU-J</p> </div> <div style="text-align: center;">  <p>*optional TAR-CT01MAU-SB</p> </div> <div style="text-align: center;">  <p>*optional</p> </div> </div>



# PCA Model

## COOLING ONLY



Indoor Unit				PCA-A24KA7	PCA-A30KA7	PCA-A36KA7	PCA-A42KA7
Outdoor Unit				PUY-A24NHA7(-BS)	PUY-A30NHA7(-BS)	PUY-A36NKA7(-BS)	PUY-A42NKA7(-BS)
Cooling	Capacity	Rated <sup>1</sup>	BTU/H	24,000	30,000	36,000	42,000
	Capacity Range	Min-Max	BTU/H	10,000-24,000	9,000-30,000	16,000-36,000	16,000-42,000
	Power Input	Rated <sup>1</sup>	W	1,960	3,190	3,270	4,110
	Moisture Removal	Pints/h		5.8	8.3	8.7	11.7
	Sensible Heat Factor			0.730	0.690	0.730	0.690
Heating	Capacity at 47°F	Rated	BTU/H	—	—	—	—
	Capacity Range	Min-Max	BTU/H	—	—	—	—
	Power Input at 47°F	Rated	W	—	—	—	—
	Capacity at 17°F	Rated	BTU/H	—	—	—	—
	Capacity at 5°F	Max	BTU/H	—	—	—	—
Efficiency	SEER			21.2	19.6	19.1	17.6
	EER			12.2	9.4	11.0	10.2
	HSPF			—	—	—	—
	COP			—	—	—	—
	ENERGY STAR <sup>®</sup> Certified			No	No	No	No
Indoor Unit	Air Flow Rate - Cooling (Quiet-Lo-Med-Hi-SHI)	Dry	CFM	530-565-600-670	565-600-635-705	775-850-920-990	810-885-955-1025
		Wet	CFM	495-530-565-635	530-565-600-670	705-775-850-920	740-810-885-955
	Air Flow Rate - Heating (Quiet-Lo-Med-Hi-SHI)	Dry	CFM	530-565-600-670	565-600-635-705	775-850-920-990	810-885-955-1025
	Sound Pressure Level (Quiet-Lo-Med-Hi-SHI)	Cooling	dB(A)	33-35-37-40	35-37-39-41	37-39-41-43	39-41-43-45
		Heating	dB(A)	33-35-37-40	35-37-39-41	37-39-41-43	39-41-43-45
	External Static Pressure		In. W.G.	—	—	—	—
	Condensate Lift Mechanism	Max Distance	In. [mm]	—	—	—	—
	Dimensions	H	In. [mm]	9-1/16 [230]	9-1/16 [230]	9-1/16 [230]	9-1/16 [230]
W		In. [mm]	50-3/8 [1280]	50-3/8 [1280]	63 [1600]	63 [1600]	
D		In. [mm]	26-3/4 [680]	26-3/4 [680]	26-3/4 [680]	26-3/4 [680]	
Weight	lbs [kg]		71 [32]	71 [32]	79 [36]	86 [39]	
Outdoor Unit	MCA	A		19.0	19.0	25.0	25.0
	MOCP	A		26	26	31	31
	Dimensions	H	In. [mm]	37-1/8 [943]	37-1/8 [943]	52-11/16 [1338]	52-11/16 [1338]
		W	In. [mm]	37-13/32 [950]	37-13/32 [950]	41-5/16 [1050]	41-5/16 [1050]
		D	In. [mm]	13 (+1-3/16) [330 (+30)]	13 (+1-3/16) [330 (+30)]	13 (+1-3/16) [330 (+30)]	13 (+1-3/16) [330 (+30)]
	Weight	lbs [kg]		151 [68]	151 [68]	211 [96]	211 [96]
	Air Flow Rate (Cooling/Heating)	CFM		1940/—	1940/—	3880/—	3880/—
	Sound Pressure Level	Cooling	dB(A)	47	47	52	52
Heating		dB(A)	—	—	—	—	
Piping	Diameter	Gas (O.D.)	In. [mm]	5/8 [15.88]	5/8 [15.88]	5/8 [15.88]	5/8 [15.88]
		Liquid (O.D.)	In. [mm]	3/8 [9.52]	3/8 [9.52]	3/8 [9.52]	3/8 [9.52]
		Indoor Drain	In. [mm]	1-1/32 [26]	1-1/32 [26]	1-1/32 [26]	1-1/32 [26]
	Max. Length	ft [m]		225 [68]	225 [68]	225 [68]	225 [68]
Max. Height	ft [m]		100 [30]	100 [30]	100 [30]	100 [30]	
Electrical	Outdoor-Indoor <sup>2</sup>	V, ph, Hz		208/230, 1, 60	208/230, 1, 60	208/230, 1, 60	208/230, 1, 60
	Recommended Breaker Size	A		25	25	30	30
Refrigerant Type				R410A	R410A	R410A	R410A
Guaranteed Temperature Operation Range	Cooling <sup>3</sup>	°F DB [°C DB]		-40.0 to 115.0 [-40.0 to 46.0]	-40.0 to 115.0 [-40.0 to 46.0]	-40.0 to 115.0 [-40.0 to 46.0]	-40.0 to 115.0 [-40.0 to 46.0]
	Heating	°F DB [°C DB]		—	—	—	—

Notes:

AHRI Rated Conditions  
(Rated data is determined at a fixed compressor speed)

<sup>1</sup>Cooling (Indoor // Outdoor)

<sup>2</sup> 80 DB, 67 WB // 95 DB, 75 WB

<sup>3</sup>Indoor units receive power from outdoor units through field-supplied interconnected wiring.

<sup>4</sup>Wind baffles required to operate below 23°F DB in cooling mode. PUY with wind baffle: -40°F - 115°F. Refer to wind baffle documentation for further information.

SEACOAST PROTECTION

- External Outer Panel: Phosphate coating + Acrylic-Enamel coating
- Fan Motor Support: Epoxy resin coating (at edge face)
- Separator Assembly; Valve Bed: Epoxy resin coating (at edge face)
- "Blue Fin" treatment is an anti-corrosion treatment that is applied to the condenser coil to protect it against airborne contaminants.

# PCA Model

## HEAT PUMP

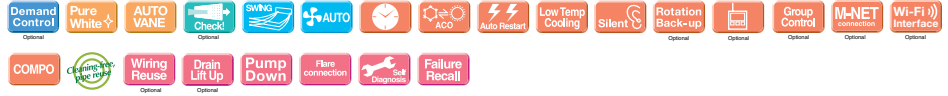

Indoor Unit				PCA-A24KA7	PCA-A30KA7	PCA-A36KA7	PCA-A42KA7
Outdoor Unit				PUZ-A24NHA7(-BS)	PUZ-A30NHA7(-BS)	PUZ-A36NKA7(-BS)	PUZ-A42NKA7(-BS)
Cooling	Capacity	Rated <sup>1</sup>	BTU/H	24,000	30,000	36,000	42,000
	Capacity Range	Min-Max	BTU/H	10,000-24,000	9,000-30,000	16,000-36,000	16,000-42,000
	Power Input	Rated <sup>1</sup>	W	1,960	3,190	3,270	4,110
	Moisture Removal	Pints/h		5.8	8.3	8.7	11.7
	Sensible Heat Factor			0.730	0.690	0.730	0.690
Heating	Capacity at 47°F	Rated <sup>2</sup>	BTU/H	26,000	32,000	38,000	45,000
	Capacity Range	Min-Max	BTU/H	8,800-28,000	8,600-34,000	17,900-40,000	18,100-48,000
	Power Input at 47°F	Rated <sup>2</sup>	W	1,800	2,520	2,410	3,480
	Capacity at 17°F	Rated <sup>3</sup>	BTU/H	15,400	18,800	21,000	31,800
		Max	BTU/H	17,900	21,600	24,400	35,000
	Capacity at 5°F	Max <sup>4</sup>	BTU/H	—	—	—	—
Efficiency	SEER			21.2	19.6	19.1	17.6
	EER			12.2	9.4	11.0	10.2
	HSPF			10.8	10	10.2	10.2
	COP			4.23	3.72	4.62	3.78
	ENERGY STAR <sup>®</sup> Certified			No	No	No	No
Indoor Unit	Air Flow Rate - Cooling (Quiet-Lo-Med-Hi-SHI)	Dry	CFM	530-565-600-670	565-600-635-705	775-850-920-990	810-885-955-1025
		Wet	CFM	495-530-565-635	530-565-600-670	705-775-850-920	740-810-885-955
	Air Flow Rate - Heating (Quiet-Lo-Med-Hi-SHI)	Dry	CFM	530-565-600-670	565-600-635-705	775-850-920-990	810-885-955-1025
	Sound Pressure Level (Quiet-Lo-Med-Hi-SHI)	Cooling	dB(A)	33-35-37-40	35-37-39-41	37-39-41-43	39-41-43-45
		Heating	dB(A)	33-35-37-40	35-37-39-41	37-39-41-43	39-41-43-45
	External Static Pressure		In. W.G.	—	—	—	—
	Condensate Lift Mechanism	Max Distance	In. [mm]	—	—	—	—
	Dimensions	H	In. [mm]	9-1/16 [230]	9-1/16 [230]	9-1/16 [230]	9-1/16 [230]
		W	In. [mm]	50-3/8 [1280]	50-3/8 [1280]	63 [1600]	63 [1600]
		D	In. [mm]	26-3/4 [680]	26-3/4 [680]	26-3/4 [680]	26-3/4 [680]
Weight	lbs [kg]		71 [32]	71 [32]	79 [36]	86 [39]	
Outdoor Unit	MCA	A		19.0	19.0	25.0	25.0
	MOCP	A		26	26	31	31
	Dimensions	H	In. [mm]	37-1/8 [943]	37-1/8 [943]	52-11/16 [1338]	52-11/16 [1338]
		W	In. [mm]	37-13/32 [950]	37-13/32 [950]	41-5/16 [1050]	41-5/16 [1050]
		D	In. [mm]	13 (+1-3/16) [330 (+30)]	13 (+1-3/16) [330 (+30)]	13 (+1-3/16) [330 (+30)]	13 (+1-3/16) [330 (+30)]
	Weight	lbs [kg]		153 [69]	153 [69]	214 [97]	214 [97]
	Air Flow Rate (Cooling/Heating)	CFM		1940/1940	1940/1940	3880/3880	3880/3880
	Sound Pressure Level	Cooling	dB(A)	47	47	52	52
Heating		dB(A)	48	48	53	53	
Piping	Diameter	Gas (O.D.)	In. [mm]	5/8 [15.88]	5/8 [15.88]	5/8 [15.88]	5/8 [15.88]
		Liquid (O.D.)	In. [mm]	3/8 [9.52]	3/8 [9.52]	3/8 [9.52]	3/8 [9.52]
		Indoor Drain	In. [mm]	1-1/32 [26]	1-1/32 [26]	1-1/32 [26]	1-1/32 [26]
	Max. Length	ft [m]		165 [50]	165 [50]	165 [50]	165 [50]
Max. Height	ft [m]		100 [30]	100 [30]	100 [30]	100 [30]	
Electrical	Outdoor-Indoor <sup>5</sup>	V, ph, Hz		208/230, 1, 60	208/230, 1, 60	208/230, 1, 60	208/230, 1, 60
	Recommended Breaker Size	A		25	25	30	30
Refrigerant Type				R410A	R410A	R410A	R410A
Guaranteed Temperature Operation Range	Cooling <sup>6</sup>	°F DB [°C DB]		0.0 to 115.0 [-18.0 to 46.0]	0.0 to 115.0 [-18.0 to 46.0]	0.0 to 115.0 [-18.0 to 46.0]	0.0 to 115.0 [-18.0 to 46.0]
	Heating	°F DB [°C DB]		-4.0 to 70.0 [-20.0 to 21.0]	-4.0 to 70.0 [-20.0 to 21.0]	-4.0 to 70.0 [-20.0 to 21.0]	-4.0 to 70.0 [-20.0 to 21.0]

Notes:

AHRI Rated Conditions <sup>1</sup>Cooling (Indoor // Outdoor) °F 80 DB, 67 WB // 95 DB, 75 WB  
 (Rated data is determined at a fixed compressor speed) <sup>2</sup>Heating at 47°F (Indoor // Outdoor) °F 70 DB, 60 WB // 47 DB, 43 WB  
<sup>3</sup>Heating at 17°F (Indoor // Outdoor) °F 70 DB, 60 WB // 17 DB, 15 WB  
 Conditions <sup>4</sup>Heating at 5°F (Indoor // Outdoor) °F 70 DB, 60 WB // 5 DB, 4 WB

<sup>5</sup>Indoor units receive power from outdoor units through field-supplied interconnected wiring.

<sup>6</sup>Wind baffles required to operate below 23°F DB in cooling mode. PUZ with wind baffle: 0° F - 115° F. Refer to wind baffle documentation for further information.

SEACOAST PROTECTION

- External Outer Panel: Phosphate coating + Acrylic-Enamel coating
- Fan Motor Support: Epoxy resin coating (at edge face)
- Separator Assembly; Valve Bed: Epoxy resin coating (at edge face)
- "Blue Fin" treatment is an anti-corrosion treatment that is applied to the condenser coil to protect it against airborne contaminants.

# PCA Model

## HYPER-HEATING



Indoor Unit				PCA-A24KA7	PCA-A30KA7	PCA-A36KA7	PCA-A42KA7
Outdoor Unit				PUZ-HA24NHA	PUZ-HA30NHA5	PUZ-HA36NHA5	PUZ-HA42NKA
Cooling	Capacity	Rated <sup>1</sup>	BTU/H	24,000	30,000	34,000	42,000
	Capacity Range	Min-Max	BTU/H	10,000-24,000	18,000	18,000	19,000
	Power Input	Rated <sup>1</sup>	W	1,840	2,480	2,810	4,200
	Moisture Removal	Pints/h		5.6	8.3	8.2	11.7
	Sensible Heat Factor			0.730	0.690	0.730	0.690
Heating	Capacity at 47°F	Rated <sup>2</sup>	BTU/H	26,000	32,000	38,000	48,000
	Capacity Range	Min-Max	BTU/H	10,000-28,000	18,000-35,000	18,000-40,000	21,000-54,000
	Power Input at 47°F	Rated <sup>2</sup>	W	2,050	2,990	3,270	4,150
	Capacity at 17°F	Rated <sup>3</sup>	BTU/H	17,700	19,000	27,000	44,000
	Capacity at 5°F	Max <sup>4</sup>	BTU/H	26,000	32,000	38,000	48,000
Efficiency	SEER			18.5	16.1	16.6	14.5
	EER			12.5	12.1	12.1	10.0
	HSPF			10.8	9.3	10.3	10.4
	COP			3.5	3.14	3.4	3.38
	ENERGY STAR <sup>®</sup> Certified			Yes	No	No	No
Indoor Unit	Air Flow Rate - Cooling (Quiet-Lo-Med-Hi-SHi)	Dry	CFM	530-565-600-670	565-600-635-705	775-850-920-990	810-885-955-1025
		Wet	CFM	495-530-565-635	530-565-600-670	705-775-850-920	740-810-885-955
	Air Flow Rate - Heating (Quiet-Lo-Med-Hi-SHi)	Dry	CFM	530-565-600-670	565-600-635-705	775-850-920-990	810-885-955-1025
	Sound Pressure Level (Quiet-Lo-Med-Hi-SHi)	Cooling	dB(A)	33-35-37-40	35-37-39-41	37-39-41-43	39-41-43-45
		Heating	dB(A)	33-35-37-40	35-37-39-41	37-39-41-43	39-41-43-45
	External Static Pressure		In. W.G.	—	—	—	—
	Condensate Lift Mechanism	Max Distance	In. [mm]	—	—	—	—
	Dimensions	H	In. [mm]	9-1/16 [230]	9-1/16 [230]	9-1/16 [230]	9-1/16 [230]
		W	In. [mm]	50-3/8 [1280]	50-3/8 [1280]	63 [1600]	63 [1600]
D		In. [mm]	26-3/4 [680]	26-3/4 [680]	26-3/4 [680]	26-3/4 [680]	
Weight	lbs [kg]		71 [32]	71 [32]	79 [36]	86 [39]	
Outdoor Unit	MCA	A		19.0	28.0	28.0	37.0
	MOCP	A		26	40	40	44
	Dimensions	H	In. [mm]	37-1/8 [943]	53-1/8 [1375]	53-1/8 [1375]	52-11/16 [1338]
		W	In. [mm]	37-13/32 [950]	37-3/8 [950]	37-3/8 [950]	41-3/8 [1051]
		D	In. [mm]	13 [+1-3/16] [330 [+30]]	13 [+1-3/16] [330 [+30]]	13 [+1-3/16] [330 [+30]]	13 [+1-3/16] [330 [+30]]
	Weight	lbs [kg]		85 [188]	265 [120]	265 [120]	287 [130]
	Air Flow Rate (Cooling/Heating)	CFM		1940/1940	3530/3530	3530/3530	3320/3320
	Sound Pressure Level	Cooling	dB(A)	52	52	52	49
Heating		dB(A)	53	53	53	51	
Piping	Diameter	Gas (O.D.)	In. [mm]	5/8 [15.88]	5/8 [15.88]	5/8 [15.88]	5/8 [15.88]
		Liquid (O.D.)	In. [mm]	3/8 [9.52]	3/8 [9.52]	3/8 [9.52]	3/8 [9.52]
		Indoor Drain	In. [mm]	1-1/32 [26]	1-1/32 [26]	1-1/32 [26]	1-1/32 [26]
	Max. Length	ft [m]		165 [50]	245 [75]	245 [75]	245 [75]
Max. Height	ft [m]		100 [30]	100 [30]	100 [30]	100 [30]	
Electrical	Outdoor-Indoor <sup>5</sup>	V, ph, Hz		208/230, 1, 60	208/230, 1, 60	208/230, 1, 60	208/230, 1, 60
	Recommended Breaker Size	A		25	30	30	40
Refrigerant Type				R410A	R410A	R410A	R410A
Guaranteed Temperature Operation Range	Cooling <sup>6</sup>	°F DB [°C DB]		0.0 to 115.0 [-18.0 to 46.0]	0.0 to 115.0 [-18.0 to 46.0]	0.0 to 115.0 [-18.0 to 46.0]	0.0 to 115.0 [-18.0 to 46.0]
	Heating	°F DB [°C DB]		-13.0 to 70.0 [-25.0 to 21.0]	-13.0 to 70.0 [-25.0 to 21.0]	-13.0 to 70.0 [-25.0 to 21.0]	-13.0 to 70.0 [-25.0 to 21.0]

Notes:  
 AHRI Rated Conditions (Rated data is determined at a fixed compressor speed) <sup>1</sup>Cooling (Indoor // Outdoor) °F 80 DB, 67 WB // 95 DB, 75 WB  
<sup>2</sup>Heating at 47°F (Indoor // Outdoor) °F 70 DB, 60 WB // 47 DB, 43 WB  
<sup>3</sup>Heating at 17°F (Indoor // Outdoor) °F 70 DB, 60 WB // 17 DB, 15 WB  
 Conditions <sup>4</sup>Heating at 5°F (Indoor // Outdoor) °F 70 DB, 60 WB // 5 DB, 4 WB  
<sup>5</sup>Indoor units receive power from outdoor units through field-supplied interconnected wiring.  
<sup>6</sup>Wind baffles required to operate below 23°F DB in cooling mode. PUZ with wind baffle: 0° F - 115° F.





# MULTI- ZONE Series









# SELECTION

Choose from six types of indoor units and thirteen outdoor units that can run up to eight indoor units each.

## STEP 1

## SELECT INDOOR UNIT







Select the indoor unit to be installed in each room.

<b>Wall Mounted</b>  <b>WPH</b>  <b>MSZ-EF</b>  <b>NTXWST</b>	<b>Floor Mounted</b>  <b>FKS</b>	<b>Multi-Position Air Handler</b>  <b>AMT</b>	<b>Ceiling Cassette</b>  <b>CKS</b>  <b>PLA</b>  <b>UKS</b>	<b>Ceiling Suspended</b>  <b>PCA</b> <b>Horizontal Ducted</b>  <b>DKS</b>  <b>PEAD</b>
--	---	--	--	--

## STEP 2

## SELECT OUTDOOR UNIT

Select the best outdoor unit based on the number of indoor units and overall system capacity required.

<b>2-port</b> up to 2 indoor units  <b>NTXMMX20A122A*</b>	<b>3-port</b> up to 3 indoor units  <b>NTXMMX24A132A*</b> <b>NTXMMX30A132A*</b>	<b>4-port</b> up to 4 indoor units  <b>NTXMMX36A142A*</b>	<b>5-port</b> up to 5 indoor units  <b>NTXMMX42A152A*</b>	<b>8-port</b> up to 8 indoor units  <b>NTXMMX48A182A*</b> <b>NTXMMX60A182A*</b>
<b>Pro-Heat</b> <b>2-port</b> up to 2 indoor units  <b>NTXMPH20A122A*</b>	<b>Pro-Heat</b> <b>3-port</b> up to 3 indoor units  <b>NTXMPH24A132A*</b> <b>NTXMPH30A132A*</b>	<b>Pro-Heat</b> <b>4-port</b> up to 4 indoor units  <b>NTXMPH36A142A*</b>	<b>Pro-Heat</b> <b>5-port</b> up to 5 indoor units  <b>NTXMPH42A152A*</b>	<b>Pro-Heat</b> <b>8-port</b> up to 8 indoor units  <b>NTXMMX48A182A*</b>

## STEP 3

## CHECK SYSTEM COMPATIBILITY

Possible combinations depends on the outdoor unit chosen. Please check the following points.

### Check Indoor Units

Refer to the Indoor Unit Compatibility Table to check if the indoor units selected can be used with the outdoor unit selected. (Indoor units not listed in the table cannot be used.)

### Check Indoor Unit Capacity Combination

Refer to the Combination Table to check if the capacity combination of the indoor unit selected is connectible. (Combinations not listed cannot be connected.)

**If the desired combination cannot be found, please change either the indoor or outdoor unit to match one of the combinations shown in the tables.**

# MX Model

Advancements in the MX Models include efficiency and flexibility in system expansion capabilities. The best solution when requiring multi-system air conditioning needs.

Outdoor Unit



## EXAMPLE SYSTEM

Smaller MX 2, 3, 4 and 5 ports  
(example of NTXMMX42A152\*\* system)



NTXMMX48A182\*\*  
NTXMMX60A182\*\*

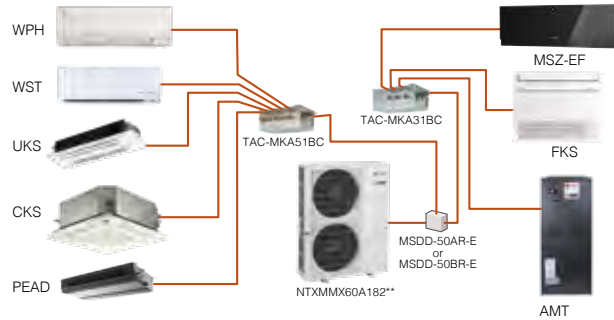

Refer to the multi-zone compatibility table on page 9.

## Handle Up to 8 Rooms with a Single Outdoor Unit

The MX Model offers a seven-system line-up to choose from, ranging between 20,000 and 60,000 BTU/H. All of them are compatible with specific Nv- and P-Series indoor units. A single outdoor unit can handle a wide range of building layouts.

## Optional Drain for All Models

With MX Model one outdoor unit can cool and heat up to eight rooms. They can be installed neatly in sites with limited space such as condominium balconies.

\*Please note that cooling and heating modes cannot be run simultaneously in different rooms.

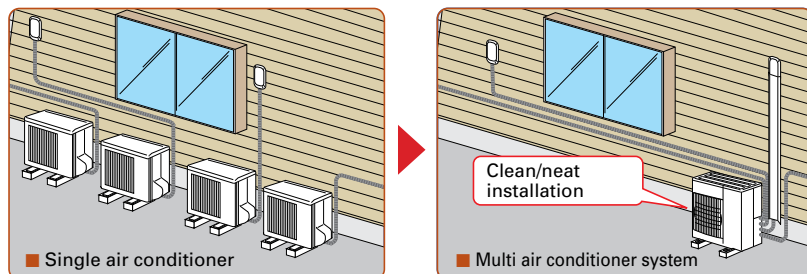



# MX Model

## INVERTER MULTI



Type				Up to 2 indoor units	Up to 3 indoor units	Up to 4 indoor units	Up to 5 indoor units	Up to 8 indoor units		
Outdoor Unit				NTXMMX20A122A*	NTXMMX24A132A*	NTXMMX30A132A*	NTXMMX36A142A*	NTXMMX42A152A*	NTXMMX48A182A*	NTXMMX60A182A*
Branch Box Required				No	No	No	No	No	Yes	Yes
Power Supply	Source			R410A	R410A	R410A	R410A	R410A	R410A	R410A
	Outdoor (Phase, Hz, V)			1-phase, 60Hz, 208/230V	1-phase, 60Hz, 208/230V	1-phase, 60Hz, 208/230V	1-phase, 60Hz, 208/230V	1-phase, 60Hz, 208/230V	1-phase, 60Hz, 208/230V	1-phase, 60Hz, 208/230V
Cooling	Capacity	Rated *1	BTU/H	18,000	22,000	28,400	35,400	40,500	48,000	60,000
	SEER			Refer to page 148						
Heating	Capacity	Rated *1	BTU/H	22,000	25,000	28,600	36,000	45,000	54,000	66,000
		Max at 17F *2	BTU/H	12,500	19,600	21,000	26,600	30,500	36,600	65,000
		Max at 5F *3	BTU/H	11,100	18,200	18,200	24,000	26,000	32,400	57,000
	HSPF			Refer to page 148						
Outdoor Unit	MCA		A	17.2	22.1	22.1	22.1	32.5	35.0	46.0
	Recommended Fuse/Breaker Size		A	20	25	25	25	40	40	50
	Dimensions	W	In. [mm]	33-1/16 [840]	37-13/32 [950]	37-13/32 [950]	37-13/32 [950]	37-13/32 [950]	41-11/32 [1,050]	41-11/32 [1,050]
		D	In. [mm]	13 [330]	13 [330]	13 [330]	13 [330]	13 [330]	13+1 [330+25]	13+1 [330+25]
		H	In. [mm]	27-15/16 [710]	31-11/32 [796]	31-11/32 [796]	31-11/32 [796]	41-17/64 [1,048]	52-11/16 [1,338]	52-11/16 [1,338]
	Weight		lbs [kg]	126 [57]	137 [62]	137 [62]	139 [63]	189 [86]	271 [123]	302 [137]
Air volume (Cooling/Heating)		CFM	1,342/1,458	2,287/2,382	2,287/2,382	2,287/2,382	2,118/2,542	3,885	4,879	
Sound Level	Cooling	dB [A]	50	51	52	54	56	51	58	
	Heating	dB [A]	54	55	56	56	58	54	59	
Piping	Diameter	Gas	In. [mm]	3/8 [9.52]	A: 1/2 [12.7] B,C: 3/8 [9.52]	A: 1/2 [12.7] B,C: 3/8 [9.52]	A: 1/2 [12.7] B,C,D: 3/8 [9.52]	A: 1/2 [12.7] B,C,D,E: 3/8 [9.52]	5/8 [15.88]	3/4 [19.05]
		Liquid	In. [mm]	1/4 [6.35]	1/4 [6.35]	1/4 [6.35]	1/4 [6.35]	1/4 [6.35]	3/8 [9.52]	3/8 [9.52]
	Max. Length	ft [m]	164 [50]	230 [70]	230 [70]	230 [70]	262 [80]	492 [150]	492 [150]	
Height		ft [m]	49 [15]	49 [15]	49 [15]	49 [15]	49 [15]	164 [50]	164 [50]	
Guaranteed Operation Range	Cooling	F [C]	14 ~ 115°FDB [-10 ~ 46°CDB]	14 ~ 115°FDB [-10 ~ 46°CDB]	14 ~ 115°FDB [-10 ~ 46°CDB]	14 ~ 115°FDB [-10 ~ 46°CDB]	14 ~ 115°FDB [-10 ~ 46°CDB]	23 ~ 115°FDB [-5 ~ 46°CDB] *5	23 ~ 115°FDB [-5 ~ 46°CDB] *5	
	Heating	F [C]	5 ~ 75°FDB [-15 ~ 24°CDB]	5 ~ 75°FDB [-15 ~ 24°CDB]	5 ~ 75°FDB [-15 ~ 24°CDB]	5 ~ 75°FDB [-15 ~ 24°CDB]	5 ~ 75°FDB [-15 ~ 24°CDB]	-4 ~ 70°FDB [-20 ~ 21°CDB]	-4 ~ 70°FDB [-20 ~ 21°CDB]	

NOTE: Test conditions are based on AHRI 210/240.

\*1 Rating Conditions (Cooling) - Indoor: 80° FDB, 67° FWB, Outdoor: 95° FDB, (75° FWB)  
(Heating) - Indoor: 70° FDB, 60° FWB, Outdoor: 47° FDB, 43° FWB

\*2 Rating Conditions (Heating) - Indoor: 70° FDB, 60° FWB, Outdoor: 17° FDB, 15° FWB

\*3 Rating Conditions (Heating) - Indoor: 70° FDB, 60° FWB, Outdoor: 5° FDB, 5° FWB

\*5 °F DB - 115°F DB when optional wind baffles are installed

Type	Branch Box				
Model Name	TAC-MKA31BC		TAC-MKA51BC		
Connectible Number of Indoor Units	Maximum 3		Maximum 5		
Power Supply	1-phase, 60Hz, 208/230V		1-phase, 60Hz, 208/230V		
Input	kW		0.003		
Running Current	A		0.05		
Dimensions	W	In. [mm]	17-23/32 [450]	17-23/32 [450]	
	D	In. [mm]	11-1/32 [280]	11-1/32 [280]	
	H	In. [mm]	6-11/16 [170]	6-11/16 [170]	
Weight	lbs [kg]		15 [6.7]		
Piping Connection (Flare)	Branch (indoor side)*	Gas	In. [mm]	3/8 [9.52] × 3	3/8 [9.52] × 4 1/2 [12.7] × 1
		Liquid	In. [mm]	1/4 [6.35] × 3	1/4 [6.35] × 5
	Main (outdoor side)*	Gas	In. [mm]	5/8 [15.88]	5/8 [15.88]
		Liquid	In. [mm]	3/8 [9.52]	3/8 [9.52]

\*The piping connection size differs according to the type and capacity of indoor units. Match the piping connection size for indoor and branch box. If the piping connection size of branch box does not match the piping connection size of indoor units, use optional different-diameter (deformed) joints to the branch box side. (Connect deformed joint directly to the branch box side.)

# MPH Model

**Pro-Heat**

New Pro-Heat MX allows you to create an oasis of comfort throughout your home and office, in the rooms you use most, any time of the year.



Standard rated heating capacity is maintained even when the outside-air temperature drops to 5° F.

Maintains high capacity output even when outside-air temperature is low.

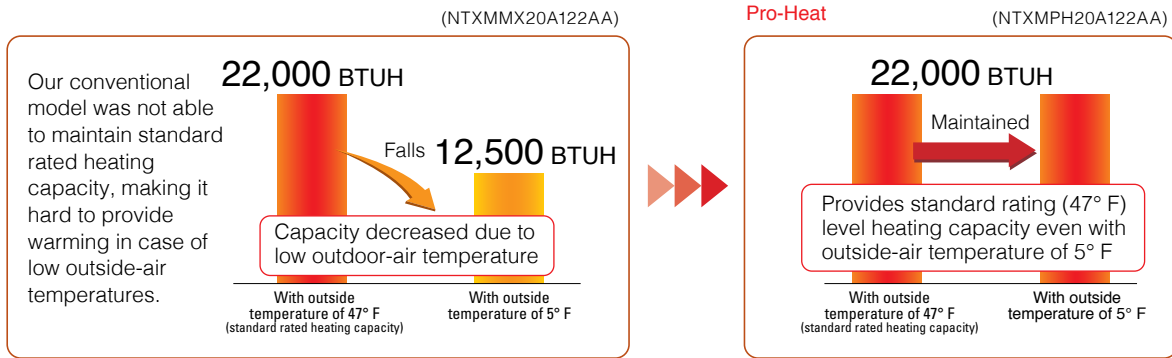

Can operate at outside-air temperature of -13° F

1. Incorporated key parts resistant to cold of up to -13° F after rigorous selection.
2. Printed circuit board is coated on both sides to protect it in harsh environments.

Base pan heater built-in

Prevents capacity loss and operation from stopping due to drain water freezing.

Drain water **freezes** after operation in the harsh cold



Without base heater

Pro-Heat

Does not freeze

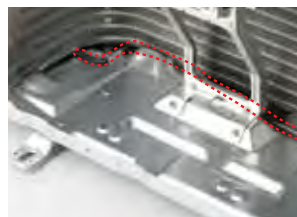

With base heater



# Continuous heating for long periods

Wasteful defrosting operation suppressed to enable more comfortable long-term continuous heating.

Extremely cold outside

Pro-Heat



During defrosting operation, the unit stops and is cold...



MPH Model

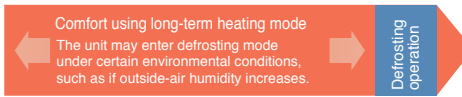

MMX Model



Type			Up to 2 indoor units	Up to 3 indoor units		Up to 4 indoor units	Up to 5 indoor units	Up to 8 indoor units	
Outdoor Unit			NTXMPH20A122A*	NTXMPH24A132A*	NTXMPH30A132A*	NTXMPH36A142A*	NTXMPH42A152A*	NTXMMX48A182A*	
Branch Box Required			No	No	No	Yes	Yes	Yes	
Power Supply	Source		R410A	R410A	R410A	R410A	R410A	R410A	
	Outdoor (Phase, Hz, V)		1-phase, 60Hz, 208/230V	1-phase, 60Hz, 208/230V	1-phase, 60Hz, 208/230V	1-phase, 60Hz, 208/230V	1-phase, 60Hz, 208/230V	1-phase, 60Hz, 208/230V	
	Recommended Breaker Size		40	40	40	50			
Cooling	Capacity	Rated *1	BTU/H	18,000	22,000	28,400	36,000	42,000	48,000
	SEER		Refer to page 148						
	EER		Refer to page 148						
Heating	Capacity	Rated *1	BTU/H	22,000	25,000	28,600	45,000	48,000	54,000
		Max at 17F *2	BTU/H	22,000	25,000	28,600	45,000	48,000	54,000
		Max at 5F *3	BTU/H	22,000	25,000	28,600	45,000	48,000	54,000
	HSPF		Refer to page 148						
Outdoor Unit	MCA		A	29.5	30.5	30.5	42	42	42
	Recommended breaker/fuse size		A	40	40	50	45	45	45
	Dimensions	W	In. [mm]	37-13/32 [950]	37-13/32 [950]	41-11/32 [1,050]	41-11/32 [1,050]	41-11/32 [1,050]	41-11/32 [1,050]
		D	In. [mm]	13 [330]	13 [330]	13 [330]	13+1 [330+25]	13+1 [330+25]	13+1 [330+25]
		H	In. [mm]	41-17/64 [1,048]	41-17/64 [1,048]	41-17/64 [1,048]	52-11/16 [1,338]	52-11/16 [1,338]	52-11/16 [1,338]
	Weight		lbs [kg]	187 [85]	189 [86]	189 [86]	278 [126]	278 [126]	278 [126]
	Air volume (Cooling/Heating)	CFM		2,118/2,542	2,188/2,542	2,224/2,542	3,885	3,885	3,885
	Sound Level	Cooling	dB [A]	54	54	54	49	50	51
Heating		dB [A]	58	58	58	53	54	54	
Piping	Diameter	Gas	In. [mm]	3/8 [9.52]	A: 1/2 [12.7] B,C: 3/8 [9.52]	A: 1/2 [12.7] B,C: 3/8 [9.52]	5/8 [15.88]	5/8 [15.88]	5/8 [15.88]
		Liquid	In. [mm]	1/4 (6.35)	1/4 (6.35)	1/4 (6.35)	3/8 [9.52]	3/8 [9.52]	3/8 [9.52]
	Max. Length		ft [m]	164 [50]	230 [70]	230 [70]	492 [150]	492 [150]	492 [150]
	Height		ft [m]	49 [15]	49 [15]	49 [15]	164 [50]	164 [50]	164 [50]
Guaranteed Operation Range	Cooling	F [C]		14 ~ 115°FDB [-10 ~ 46°CDB]	14 ~ 115°FDB [-10 ~ 46°CDB]	14 ~ 115°FDB [-10 ~ 46°CDB]	23 ~ 115°FDB [-5 ~ 46°CDB] *5	23 ~ 115°FDB [-5 ~ 46°CDB] *5	23 ~ 115°FDB [-5 ~ 46°CDB] *5
	Heating	F [C]		-13 ~ 75°FDB [-25 ~ 24°CDB]	-13 ~ 75°FDB [-25 ~ 24°CDB]	-13 ~ 75°FDB [-25 ~ 24°CDB]	-13 ~ 70°FDB [-25 ~ 21°CDB]	-13 ~ 70°FDB [-25 ~ 21°CDB]	-13 ~ 70°FDB [-25 ~ 21°CDB]

NOTE: Test conditions are based on AHRI 210/240.

\*1 Rating Conditions (Cooling) - Indoor: 80° FDB, 67° FWB, Outdoor: 95° FDB, (75° FWB)

(Heating) - Indoor: 70° FDB, 60° FWB, Outdoor: 47° FDB, 43° FWB

\*2 Rating Conditions (Heating) - Indoor: 70° FDB, 60° FWB, Outdoor: 17° FDB, 15° FWB

\*3 Rating Conditions (Heating) - Indoor: 70° FDB, 60° FWB, Outdoor: 5° FDB, 5° FWB

\*5 °F DB - 115°F DB when optional wind baffles are installed

# Indoor Unit Compatibility Table

## MMX Model \*1

Possible combinations of outdoor units and indoor units are shown below.

Indoor Unit		Outdoor Unit	NTXMMX20A122A*	NTXMMX24A132A*	NTXMMX30A132A*	NTXMMX36A142A*	NTXMMX42A152A*	NTXMMX48A182A*	NTXMMX60A182A*
Nv-Series	Wall Mounted	NTXWPH06A112A*	•	•	•	•	•	•	•
		NTXWPH09A112A*	•	•	•	•	•	•	•
		NTXWPH12A112A*	•	•	•	•	•	•	•
		NTXWPH15A112A*	•	•	•	•	•	•	•
		NTXWPH18A112A*		•	•	•	•	•	•
		NTXWST06A112A*	•	•	•	•	•	•	•
		NTXWST09A112A*	•	•	•	•	•	•	•
		NTXWST12A112A*	•	•	•	•	•	•	•
		NTXWST15A112A*	•	•	•	•	•	•	•
		NTXWST18A112A*		•	•	•	•	•	•
		NTXWST24A112A*			•	•	•	•	•
		MSZ-EF09NAW(S)(B)	•	•	•	•	•	•	•
		MSZ-EF12NAW(S)(B)	•	•	•	•	•	•	•
		MSZ-EF15NAW(S)(B)	•	•	•	•	•	•	•
	MSZ-EF18NAW(S)(B)		•	•	•	•	•	•	
	Floor Standing	NTXFKS09A112A*	•	•	•	•	•	•	
		NTXFKS12A112A*	•	•	•	•	•	•	
		NTXFKS15A112A*	•	•	•	•	•	•	
		NTXFKS18A112A*		•	•	•	•	•	
	EZ FIT™ Recessed Ceiling Cassette	NTXUKS09A112A*	•	•	•	•	•	•	
		NTXUKS12A112A*	•	•	•	•	•	•	
		NTXUKS18A112A*	•	•	•	•	•	•	
	Multi-position Air Handler	NTXAMT12A112A*	**2	**2	**2	**2	**2	**3, 4	
		NTXAMT18A112A*		**2	**2	**2	**2	**3, 4	
		NTXAMT24A112A*			**2	**2	**2	**3, 4	
		NTXAMT30A112A*				**2	**2	**3, 4	
		NTXAMT36A112A*						**3, 4	
	4-way Cassette	NTXCCKS09A112A*	•	•	•	•	•	•	
		NTXCCKS12A112A*	•	•	•	•	•	•	
		NTXCCKS15A112A*		•	•	•	•	•	
	Horizontal-ducted	NTXDKS09A112A*	•	•	•	•	•	**6	
		NTXDKS12A112A*	•	•	•	•	•	**6	
		NTXDKS15A112A*	•	•	•	•	•	**6	
		NTXDKS18A112A*		•	•	•	•	**6	
	P-Series	4-way Cassette	PLA-A12EA7					**5	
			PLA-A18EA7		•	•	•	**5	
PLA-A24EA7							**5		
PLA-A30EA7							**5		
PLA-A36EA7							**5		
PLA-A42EA7									
Ceiling Suspended		PCA-A24KA7			•	•	•		
		PCA-A30KA7							
		PCA-A36KA7							
		PCA-A42KA7							
Horizontal-ducted		PEAD-A12AA7	**3	**3	**3	**3	**3	**6	
	PEAD-A18AA7		•	**3	**3	**3	**6		
	PEAD-A24AA7			•	•	**3	**6		
	PEAD-A30AA7						**6		
	PEAD-A36AA7						**6		
	PEAD-A42AA7						**6		

Information is current as of this printing. Minimum installed capacity cannot be less than 12,000 BTU/H. A minimum of two indoor units must be connected to all MX outdoor units.

\*2 Only one AMT Model can be connected.

\*3 Maximum of two units can be connected unless the SPTB1 is utilized to power the indoor unit.

\*4 Single unit can be connected.

\*5 When the system includes even 1 unit of PLA-A-EA7, the number of the maximum connectable indoor units is decreased as follows: 3 for NTXMPH36A142\*\*, 4 for NTXMPH42A152\*\*, and 6 for NTXMPH48A182\*\* and NTXMMX60A182\*\*.

\*6 Maximum of 3 horizontal ducted indoor units (PEAD or DKS) can be connected.

\*7 Maximum of 2 horizontal ducted indoor units (PEAD or DKS) can be connected.

For more information, please refer to the service manual, application 1029 and the full compatibility chart on Trane.MyLinkDrive.com.

# MPH Model \*1



Possible combinations of outdoor units and indoor units are shown below.

Indoor Unit		Outdoor Unit	NTXMPH20A122A*	NTXMPH24A132A*	NTXMPH30A132A*	NTXMPH36A142A*	NTXMPH42A152A*	NTXMMX48A182A*
Nv-Series	Wall Mounted	NTXWPH06A112A*	•	•	•	•	•	•
		NTXWPH09A112A*	•	•	•	•	•	•
		NTXWPH12A112A*	•	•	•	•	•	•
		NTXWPH15A112A*	•	•	•	•	•	•
		NTXWPH18A112A*		•	•	•	•	•
		NTXWST06A112A*	•	•	•	•	•	•
		NTXWST09A112A*	•	•	•	•	•	•
		NTXWST12A112A*	•	•	•	•	•	•
		NTXWST15A112A*	•	•	•	•	•	•
		NTXWST18A112A*		•	•	•	•	•
		NTXWST24A112A*			•	•	•	•
		MSZ-EF09NAW(S)(B)	•	•	•	•	•	•
		MSZ-EF12NAW(S)(B)	•	•	•	•	•	•
		MSZ-EF15NAW(S)(B)	•	•	•	•	•	•
	MSZ-EF18NAW(S)(B)		•	•	•	•	•	
	Floor Standing	NTXFKS09A112A*	•	•	•	•	•	
		NTXFKS12A112A*	•	•	•	•	•	
		NTXFKS15A112A*	•	•	•	•	•	
		NTXFKS18A112A*		•	•	•	•	
	EZ FIT™ Recessed Ceiling Cassette	NTXUKS09A112A*	•	•	•	•	•	
		NTXUKS12A112A*	•	•	•	•	•	
		NTXUKS18A112A*	•	•	•	•	•	
	Multi-position Air Handler	NTXAMT12A112A*	**2	**2	**2	**3, 4	**3, 4	
		NTXAMT18A112A*		**2	**2	**3, 4	**3, 4	
		NTXAMT24A112A*			**2	**3, 4	**3, 4	
		NTXAMT30A112A*				**3, 4	**3, 4	
		NTXAMT36A112A*				**3, 4	**3, 4	
	4-way Cassette	NTXCKS09A112A*	•	•	•	•	•	
		NTXCKS12A112A*	•	•	•	•	•	
		NTXCKS15A112A*		•	•	•	•	
	Horizontal-ducted	NTXDKS09A112A*	•	•	•	**6	**6	
		NTXDKS12A112A*	•	•	•	**6	**6	
NTXDKS15A112A*		•	•	•	**6	**6		
NTXDKS18A112A*			•	•	**6	**6		
P-Series	4-way Cassette	PLA-A12EA7				**5	**5	
		PLA-A18EA7		•	•	**5	**5	
		PLA-A24EA7				**5	**5	
		PLA-A30EA7				**5	**5	
		PLA-A36EA7				**5	**5	
		PLA-A42EA7						
	Ceiling Suspended	PCA-A24KA7			•			
		PCA-A30KA7						
		PCA-A36KA7						
		PCA-A42KA7						
	Horizontal-ducted	PEAD-A12AA7	**3	**3	**3	**6	**6	
PEAD-A18AA7			•	**3	**6	**6		
PEAD-A24AA7				•	**6	**6		
PEAD-A30AA7					**6	**6		
PEAD-A36AA7					**6	**6		
PEAD-A42AA7					**6	**6		

Information is current as of this printing. Minimum installed capacity cannot be less than 12,000 BTU/H. A minimum of two indoor units must be connected to all MX outdoor units.

\*2 Only one AMT Model can be connected.

\*3 Maximum of two units can be connected unless the SPTB1 is utilized to power the indoor unit.

\*4 Single unit can be connected.

\*5 When the system includes even 1 unit of PLA-A-EA7, the number of the maximum connectable indoor units is decreased as follows: 3 for NTXMPH36A142\*\*, 4 for NTXMPH42A152\*\*, and 6 for NTXMPH48A182\*\* and NTXMMX60A182\*\*.

\*6 Maximum of 3 horizontal ducted indoor units (PEAD or DKS) can be connected.

\*7 Maximum of 2 horizontal ducted indoor units (PEAD or DKS) can be connected.

For more information, please refer to the service manual, application 1029 and the full compatibility chart on [Trane.MyLinkDrive.com](http://Trane.MyLinkDrive.com).

# Conditions for Specifications

Temperature conditions are based on AHRI 210/240.

Cooling	Indoor	D.B. 80° F (27° C), W.B. 67° F (19° C)
	Outdoor	D.B. 95° F (35° C), W.B. 75° F (24° C)
Heating	Indoor	D.B. 70° F (21° C), W.B. 60° F (16° C)
	Outdoor	D.B. 17° F (-8° C), W.B. 15° F (-9° C)

Refrigerant piping length: 16 ft.

The figures for total input are based on the following voltages.

Series	Indoor unit	Outdoor unit
NV-Series P-Series MX Model	-	208 / 230V • Single phase • 60Hz

Sound pressure level

- The sound pressure measurement is conducted in an anechoic chamber.
- The actual sound level depends on the distance from the unit and the acoustic environment.

# Piping Installation

## Nv-Series

Single type

Series	Class <Outdoor unit>	Maximum Piping Length (ft)	Maximum Height Difference (ft)	Maximum Number of Bends
		Total length (A)	Outdoor unit - Indoor unit (H)	Total number
NTXSPH	06/09/12	65	40	10
	15/18	100	50	10
NT(X/Y)SST	09/12/15	65	40	10
	18/24	100	50	10
NTXSMT	09/12/15/18	65	40	10
	24	100	50	10
NTXSPF	09/12	65	40	10
	15/18	100	50	10
NTXSKS/NTXSKH	09/12/15	65	40	10
	18	100	50	10
	24/30/36	100	100	10

## P-Series

Single type

Series	Class <Outdoor unit>	Maximum Piping Length (ft)	Maximum Height Difference (ft)	Maximum Number of Bends
		Total length (A)	Outdoor unit - Indoor unit (H)	Total number
PUY	12/18	165	100	15
	24/30/36/42	225		15
PUZ	12/18	100	100	15
	24/30/36/42	165		15
PUZ-HA	24/30/36/42	245	100	15

# MX Model

NTXMMX20A122AA

Maximum Piping Length	
Outdoor unit - Indoor unit (a,b)	82 ft.
Total length (a+b)	164 ft.

Maximum Number of Bends	
Outdoor unit - Indoor unit (a,b)	25
Total number (a+b)	50

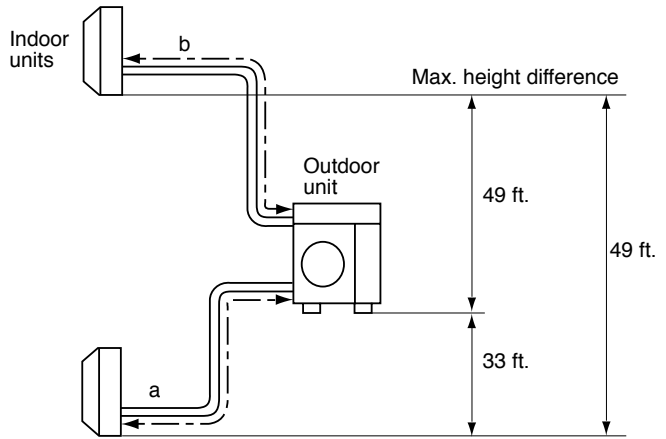

NTXMPH20A122AA

Maximum Piping Length	
Outdoor unit - Indoor unit (a,b)	82 ft.
Total length (a+b)	164 ft.

Maximum Number of Bends	
Outdoor unit - Indoor unit (a,b)	25
Total number (a+b)	50

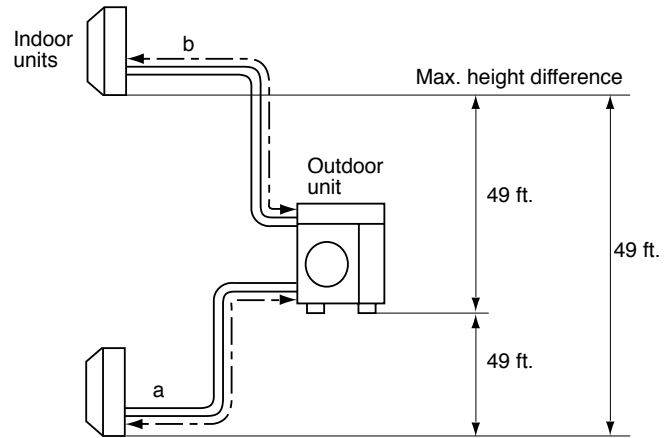

NTXMMX24A132AA, NTXMMX30A132AA,  
NTXMPH24A132AA, NTXMPH30A132AA

Maximum Piping Length	
Outdoor unit - Indoor unit (a,b,c)	82 ft.
Total length (a+b+c)	230 ft.

Maximum Number of Bends	
Outdoor unit - Indoor unit (a,b,c)	25
Total number (a+b+c)	70

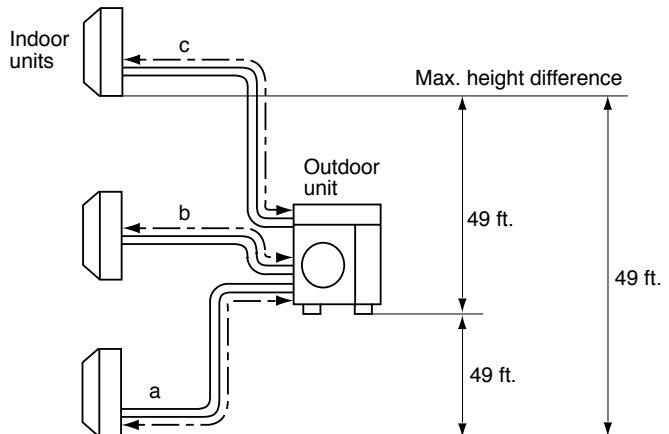



NTXMMX36A142AA

Maximum Piping Length	
Outdoor unit - Indoor unit (a,b,c,d)	82 ft.
Total length (a+b+c+d)	230 ft.

Maximum Number of Bends	
Outdoor unit - Indoor unit (a,b,c,d)	25
Total number (a+b+c+d)	70

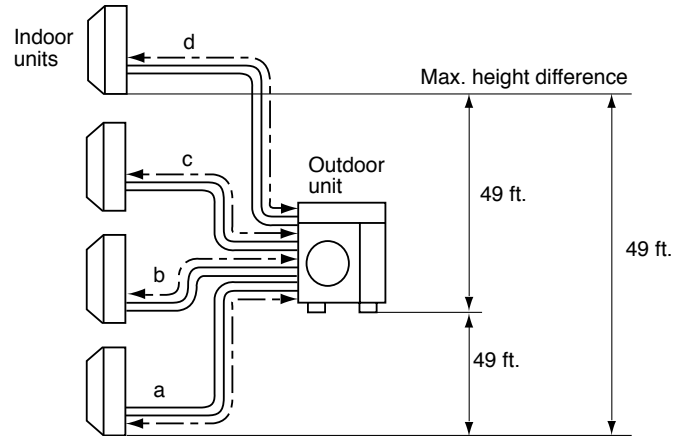

NTXMMX42A152AA

Maximum Piping Length	
Outdoor unit - Indoor unit (a,b,c,d,e)	82 ft.
Total length (a+b+c+d+e)	262 ft.

Maximum Number of Bends	
Outdoor unit - Indoor unit (a,b,c,d,e)	25
Total number (a+b+c+d+e)	80

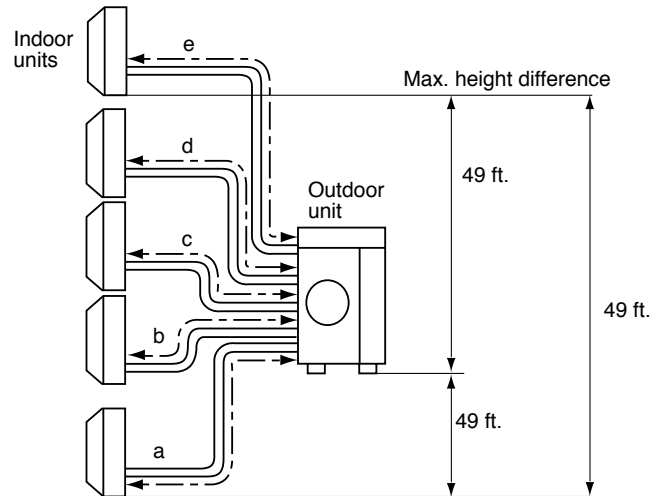



# Explanation of Terminology

## Maximum piping length:

This is the maximum allowable length of the refrigerant piping. The amount of refrigerant pipe used cannot be longer than the length specified.

### ▶ Total length:

The maximum allowable combined length of all the refrigerant piping between the outdoor unit and indoor unit(s).

### ▶ Outdoor Unit - Indoor Unit:

The maximum allowable length of the refrigerant piping between the outdoor unit and indoor units installed when multiple units are connected to a single outdoor unit. This distance limitation refers to the maximum length between the outdoor unit and the farthest indoor unit.

### ▶ Pipe length difference from distribution pipe:

The maximum allowable difference in refrigerant piping length from the distribution pipe to the farthest indoor unit and from the distribution pipe to the closest indoor unit when multiple indoor units are connected to a single outdoor unit using a distribution pipe.

### ▶ Indoor Unit - Distribution Pipe:

The maximum allowable length of the refrigerant piping between indoor units and the distribution pipe when multiple indoor units are connected to a single outdoor unit.

## Maximum height difference:

This is the maximum allowable height difference. It is necessary to install the air conditioning system so that the height distance is no more than the difference specified. (Specified differences may vary if the outdoor unit is installed higher or lower than the indoor units).

### ▶ Outdoor unit - Indoor unit:

The maximum allowable difference in height between the outdoor unit and indoor units when installed (when multiple indoor units are connected to a single outdoor unit, this distance limitation refers to the maximum height difference between the outdoor unit and an indoor unit).

### ▶ Indoor unit - Indoor unit:

The maximum allowable difference between the heights of indoor units when multiple indoor units are connected to a single outdoor unit.

## Maximum number of bends:

This is the maximum allowable number of bends in the refrigerant piping. The total number of bends in the refrigerant piping used cannot exceed the number specified.

### ▶ Total number:

The maximum allowable number of bends for all refrigerant piping between the outdoor unit and indoor units.

### ▶ Outdoor unit - Indoor unit:

The maximum allowable number of bends between the outdoor unit and each indoor unit when multiple indoor units are connected to a single outdoor unit.

To ensure full capacity in cold and snowy regions...

## 3 IMPORTANT POINTS TO REMEMBER WHEN INSTALLING THE OUTDOOR UNIT



Wind and snow can significantly reduce capacity.

Be sure to check the information below and install the outdoor unit correctly.

### 1 Installation Location

Be aware of the prevailing wind direction in winter and install the outdoor unit where it is as sheltered as possible.

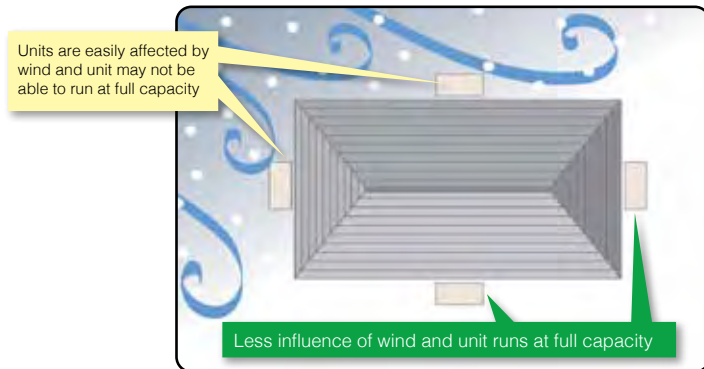

### 2 Measures for Drainage of Water

#### Case 1: Unit is installed close to passage (walkway)

Do not install the unit close to passage as drainage water from the unit may freeze and cause a slipping hazard.

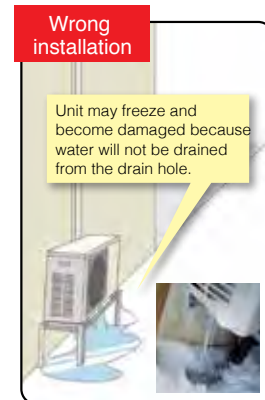
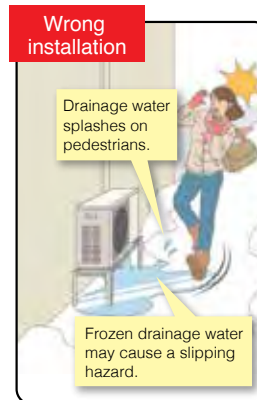
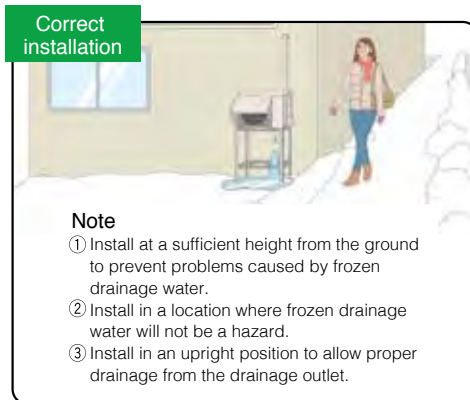

#### Case 2: Multiple units are installed

Do not install units on top of one another as it may cause frozen drainage water on the bottom unit.

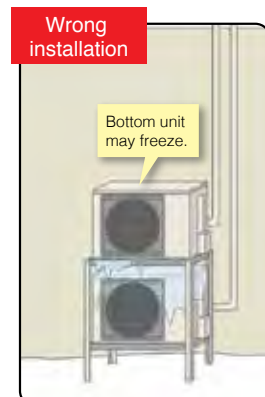
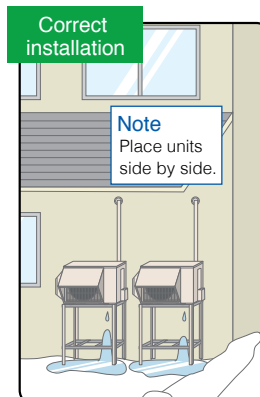

### 3 Measures for Snow

#### Do not install the unit on the ground

To avoid the adverse effects of snow and frozen drainage water, install the unit on a stand to ensure a sufficient height from the ground.

**Correct installation**



**Note**

- ① Install at a position/height to prevent the unit being buried in snow\*<sup>1</sup> and the adverse effects of frozen drainage water.\*<sup>2</sup>
- ② Install so as to avoid the effects of snow or snowdrift.
- ③ Install so as to avoid the damage from falling snow or icicles.

\*<sup>1</sup> Install at a height above the highest snowfall depth.  
\*<sup>2</sup> Even for correct installations, dripping drainage water may form an icicle which needs to be cleared away regularly to prevent a blocked drainage outlet.

**Wrong installation**

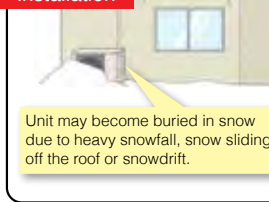

Unit may become buried in snow due to heavy snowfall, snow sliding off the roof or snowdrift.

**Wrong installation**

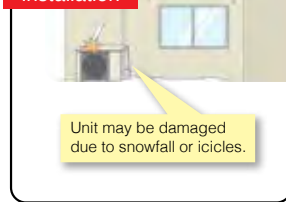

Unit may be damaged due to snowfall or icicles.

Use a stand to add sufficient height to protect the unit heat exchanger from snow and prevent icicles forming during defrost operation.

#### Install snow protection hood as necessary

**Correct installation**

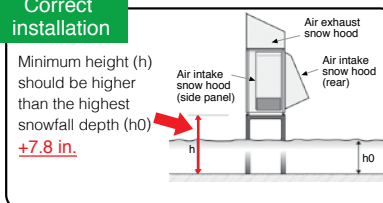

Minimum height (h) should be higher than the highest snowfall depth (h<sub>0</sub>) **+7.8 in.**

**Wrong installation**

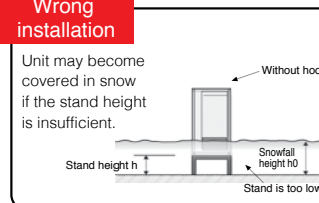

Unit may become covered in snow if the stand height is insufficient.

Without hood

Stand height h

Snowfall height h<sub>0</sub>

Stand is too low.

**Correct installation**

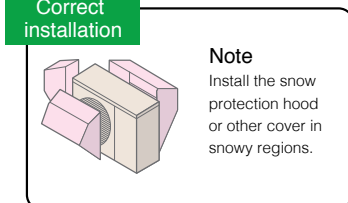

**Note**  
Install the snow protection hood or other cover in snowy regions.

#### Recommended accessories (drain socket & centralized drain pan, stand, snow protection hood, base heater)

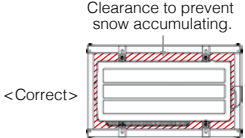
	Snowy region	Cold region	Remarks
	Countermeasures for snow	Countermeasures for freezing	
Drain socket, Centralized drain pan	Not used	Not used	Prevents freezing
Stand	Needed	Needed	<ol style="list-style-type: none"> <li>1. Install so as to prevent the unit being buried in snow (at a height greater than the highest snowfall depth). Be sure that the stand does not obstruct drainage.</li> <li>2. Install so as to prevent damage to the unit due to frozen drainage water (icicles).</li> </ol>  <p>Clearance to prevent snow accumulating.</p>
Snow protection hood	Needed *When the installation position is subject to snowfall.	—	<ol style="list-style-type: none"> <li>1. Prevents heat exchanger from being covered in snow.</li> <li>2. Prevents snow accumulating inside the air duct.</li> </ol>
Base heater	—	Needed	Outdoor units equipped with a heater for cold regions are those with an "H" in the model name. For the cold-climate zone, use of a unit with a heater is strongly recommended. Even for the moderate-climate zone use of a unit with a heater is recommended for regions subject to high humidity in winter.

### **CAUTION** About disposal of drainage water

When the unit is installed in cold or snowy regions :

**Drainage water may freeze in the drain socket/hose and prevent the fan from rotating.**



**Do not attach a drain socket packaged as an accessory to the unit.**





\* In the case that fitting a drain socket is absolutely necessary, steps must be taken so that the drainage water does not freeze. For more information, please consult Mitsubishi Electric Trane HVAC US or one of its dealers/resellers.

#### Arrangement for snow protection hood

Separately sold parts are available for some models. Please consult Mitsubishi Electric Trane HVAC US or one of its dealers/resellers at the time of purchase for details.

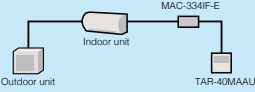
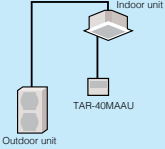
# System Control

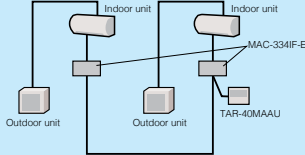
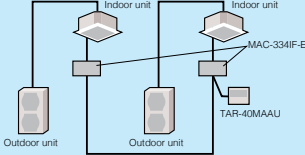
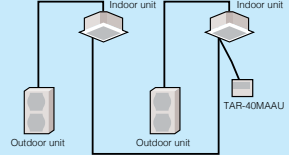
Versatile system controls can be achieved by using optional parts, relay circuits, control panels, etc.

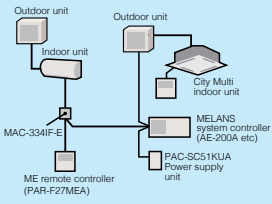
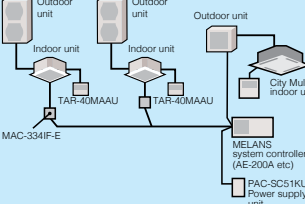
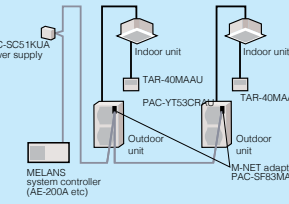
	System Examples		
Indoor Unit	Nv Series Indoor Unit	DKS, CKS, AMT	P Series Indoor Unit
Outdoor Unit	Nv Series and MX Series Outdoor	SKS and MX Series Outdoor	P Series Outdoor
 <p><b>TAR-40MAAU Control</b></p>			
Details	<ul style="list-style-type: none"> <li>Wired remote controller can be connected to indoor unit</li> </ul>	Standard equipment (for indoor units compatible with wired remote controllers)	
Major Optional Parts Required	<ul style="list-style-type: none"> <li>MAC-334IF-E (Interface)</li> <li>TAR-40MAAU (Wired remote controller)</li> </ul>	<ul style="list-style-type: none"> <li>TAR-40MAAU (Wired remote controller)</li> </ul>	
 <p><b>System Group Control</b></p>			
Details	<ul style="list-style-type: none"> <li>One remote controller can control plural air conditioners with the same settings simultaneously.</li> <li>One remote controller can control up to 16 refrigerant systems. (When connected to a MX unit, MAC-334IF-E is counted as one system.)</li> <li>Up to two remote controller can be connected.</li> </ul>		
Major Optional Parts Required	<ul style="list-style-type: none"> <li>MAC-334IF-E (Interface)</li> <li>TAR-40MAAU (Wired remote controller)</li> </ul>	<ul style="list-style-type: none"> <li>TAR-40MAAU (Wired remote controller)</li> </ul>	
 <p><b>M-NET Connections</b></p>			
Details	<ul style="list-style-type: none"> <li>Group of air conditioners can be controlled by MELANS system controller (M-NET).</li> </ul> <p>Note: When connecting to M-NET, the reduction control for the power failure automatic recovery does not operate and it will take 3 minutes to restart.</p>		
Major Optional Parts Required	<ul style="list-style-type: none"> <li>MAC-334IF-E (M-NET Interface)</li> <li>MELANS System controller</li> <li>PAC-SC51KUA (power supply unit)</li> </ul>	<ul style="list-style-type: none"> <li>PAC-SJ95MA-E/PAC-SJ96MA-E (M-NET converter)</li> <li>MELANS System controller</li> <li>PAC-SC51KUA (power supply unit)</li> </ul>	



## For Nv-Series Indoor Units

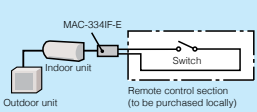
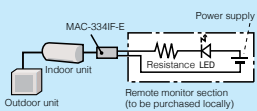

	System Examples	Connection Details	Control Details	Major Optional Parts Required
<p><b>1 Remote On/Off Operation</b></p> <ul style="list-style-type: none"> <li>Air conditioner can be started/stopped remotely. (1) and (2) can be used in combination)</li> </ul>		<p>Connect the interface to the air conditioner. Then connect the locally purchased remote controller to the terminal in the interface.</p>	<p>On/Off operation is possible from a remote location.</p>	<ul style="list-style-type: none"> <li>MAC-334IF-E (Interface)</li> <li>Parts for circuit such as relay box, lead wire, etc. (to be purchased locally)</li> </ul>
<p><b>2 Remote Display of Operation Status</b></p> <ul style="list-style-type: none"> <li>The On/Off status of air conditioners can be confirmed remotely. (1) and (2) can be used in combination)</li> </ul>		<p>Connect the interface to the air conditioner. Then connect the locally purchased remote controller to the terminal in the interface.</p>	<p>The operation status (On/Off) or error signals can be monitored from a remote location.</p>	<ul style="list-style-type: none"> <li>MAC-334IF-E (Interface)</li> <li>Parts for circuit to be purchased locally (DC power source needed)</li> <li>External power source (12V DC) is required when using MAC-334IF-E.</li> </ul>

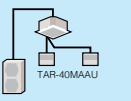
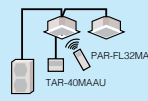
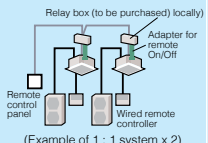
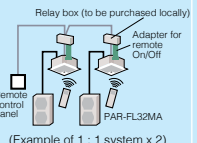
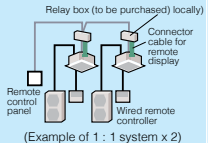
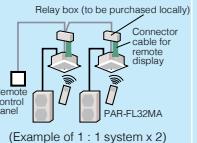
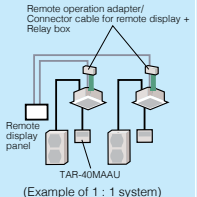
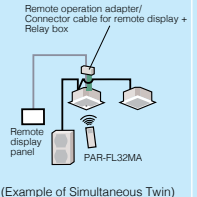
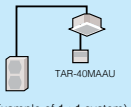
## For P-Series and CKS, DKS and AMT Indoor Units

	System Examples		Details	Major Optional Parts Required
	Wired remote controller	Wireless remote controller		
<p><b>A 2-remote Controller Control</b></p> <p>With two remote controllers, control can be performed locally and remotely from two locations.</p>	 <p>* Set "Main" and "Sub" remote controllers.</p> <p>(Example of 1 : 1 system)</p>	 <p>* When using wired and wireless remote controllers</p> <p>(Example of Simultaneous Twin)</p>	<ul style="list-style-type: none"> <li>Up to two remote controllers can be connected to one group.</li> <li>Both wired and wireless remote controllers can be used in combination.</li> </ul>	<ul style="list-style-type: none"> <li>Wired Remote Controller TAR-40MAAU</li> <li>Wireless Remote Controller PAR-FL32MA</li> <li>Wireless Remote Controller Kit for PCA PAR-SL93B-E</li> </ul>
<p><b>B Operation Control by Level Signal</b></p> <p>Air conditioner can be started/stopped remotely. In addition, On/Off operation by local remote controller can be prohibited/permitted.</p>	 <p>(Example of 1 : 1 system x 2)</p>	 <p>(Example of 1 : 1 system x 2)</p>	<ul style="list-style-type: none"> <li>Operation other than On/Off (e.g., adjustment of temperature, fan speed, and airflow) can be performed even when remote controller operation is prohibited.</li> <li>Timer control is possible with an external timer.</li> </ul>	<ul style="list-style-type: none"> <li>Adapter for remote On/Off PAC-SE55RA-E</li> <li>Relay box (to be purchased locally)</li> <li>Remote control panel (to be purchased locally)</li> </ul>
<p><b>C Operation Control by Pulse Signal</b></p>	 <p>(Example of 1 : 1 system x 2)</p>	 <p>(Example of 1 : 1 system x 2)</p>	<ul style="list-style-type: none"> <li>The pulse signal can be turned On/Off.</li> <li>Operation/emergency signal can be received at a remote location.</li> </ul>	<ul style="list-style-type: none"> <li>Connector cable for remote display PAC-SA88HA-E / PAC-725AD (10 pcs. x PAC-SA88HA-E)</li> <li>Relay box (to be purchased locally)</li> <li>Remote control panel (to be purchased locally)</li> </ul>
<p><b>D Remote Display of Operating Status</b></p> <p>Operating status can be displayed at a remote location.</p>	 <p>(Example of 1 : 1 system)</p>	 <p>(Example of Simultaneous Twin)</p>	<ul style="list-style-type: none"> <li>Operation/emergency signal can be received at a remote location (when channeled through the PAC-SF40RM-E → no-voltage signal, when channeled through the PAC-SA88HA-E → DC 12V signal).</li> </ul>	<ul style="list-style-type: none"> <li>Remote display panel (to be purchased locally)</li> <li>Connector cable for remote display PAC-SA88HA-E / PAC-725AD (10 pcs. x PAC-SA88HA-E)</li> <li>Relay box (to be purchased locally)</li> <li>Remote operation adapter PAC-SF40RM-E</li> </ul> <p>*Unable to use with wireless remote controller</p>
<p><b>E Timer Operation</b></p> <p>Allows On/Off operation with timer</p> <p>*For control by an external timer, refer to [B] Operation Control by Level Signal.</p>	 <p>(Example of 1 : 1 system)</p>		<ul style="list-style-type: none"> <li><b>Weekly Timer:</b> On/Off and up to 8 pattern temperatures can be set for each calendar day. (Initial setting)</li> <li><b>On/Off Timer:</b> On/Off can be set once each within 72 hr in intervals of 5-minute units.</li> <li><b>Auto-off Timer:</b> Operation will be switched off after a certain time elapse. Set time can be changed from 30 min. to 4 hr. at 10 min. intervals.</li> </ul> <p>*Simple Timer and Auto-off Timer cannot be used at the same time.</p>	<p>Standard functions of TAR-40MAAU</p>

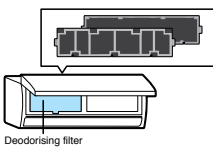
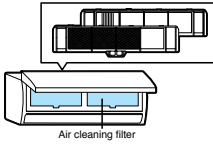
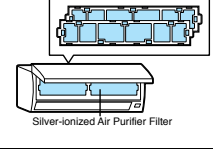
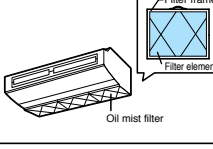
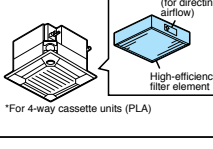
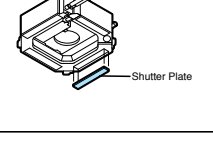
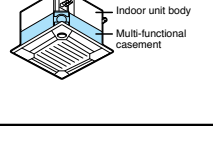
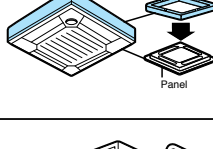
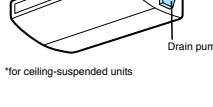
# Other Optional Parts

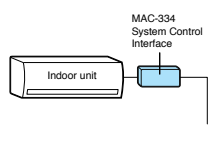
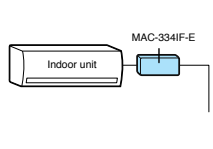
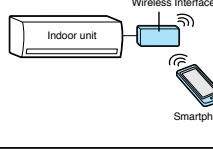
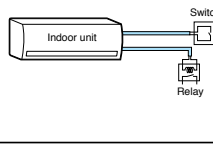
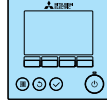
Part Name	Description
<b>Deodorizing Filter</b> Captures small foul-smelling substances in the air.	 Deodorising filter
<b>Air cleaning Filter</b> Removes fine dust particles from the air by means of static electricity.	 Air cleaning filter
<b>Silver-ionized Air Purifier Filter</b> Captures the bacteria, pollen and other allergens in the air and neutralizes them.	 Silver-ionized Air Purifier Filter
<b>Oil Mist Filter Element</b> Filter element (12 pieces) that blocks the oil mist for ceiling-suspended models used in professional kitchens.	 Oil mist filter
<b>High-efficiency Filter Element</b> Element for high-efficiency filter. Removes fine dust particles from the air.	 *For 4-way cassette units (PLA)
<b>Shutter Plate</b> Plate for blocking an air outlet of the 4-way cassette (PLA) indoor unit.	 Shutter Plate
<b>Multi-functional Casement</b> Casement for fresh-air intake and attaching the high-efficiency filter element (optional).	 Indoor unit body Multi-functional casement
<b>Space Panel</b> Decorative cover for the installation when the ceiling height is low.	 Space Panel Panel
<b>Drain Pump</b> Pumps drain water to a point higher than that where the unit is installed.	 *for ceiling-suspended units Drain pump

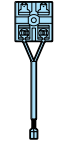
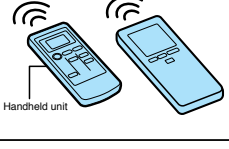
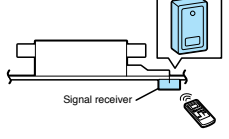
Part Name	Description
<b>MAC-334IF-E System Control Interface</b> Interface for connecting with the PAR-40MAAU remote controller and PACYT53CRAU, and to relay operation signals.	 MAC-334 System Control Interface
Interface to connect with M-NET controllers.	 MAC-334IF-E
<b>kumo cloud® Wireless Interface 2</b> Interface enabling users to control air conditioners and check operating status via devices such as personal computers, tablets and smart phones.	 Wireless Interface 2 Smartphone
<b>CN24 Relay Kit</b> This product is an adaptor which inputs the incoming signals from an open/close switch to the air conditioner and outputs the on/off signals from the air conditioner to the back-up heater.	 Switch Relay
<b>Deluxe MA Wired Controller</b> Advanced deluxe remote controller with full dot liquid-crystal display and backlight. Equipped with convenient functions like night setback.	
<b>Simple MA Wired Controller</b> Remote controller with liquid-crystal display, and backlight function for operation in dark location.	
<b>Remote Controller Terminal Block Kit for PKA</b> The terminal block is used as a relay to wire an indoor unit and to two remote controllers or to wire a remote controller and multiple indoor units in order to perform group control.	
<b>Wireless Remote Controller Signal Sender</b> Handheld unit for sending operation signals to the indoor unit.	 Handheld unit
<b>Wireless Remote Controller Signal Receiver</b> Receives operation signals from the wireless remote controller handheld unit.	 Signal receiver

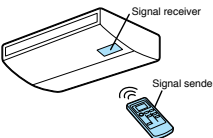
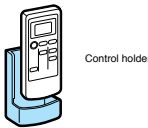
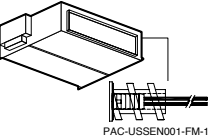
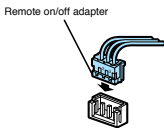
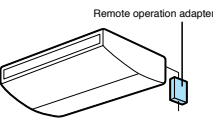
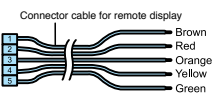
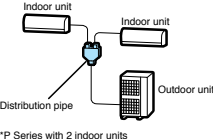
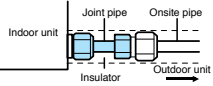
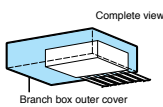
Part Name	Description
<b>Wireless Remote Controller Kit (Sender &amp; Receiver)</b> Remote controller handheld unit (signal sender) and receiver (signal receiver) for ceiling-suspended units.	
<b>Control Holder</b> Holder for storing the remote controller.	
<b>Remote Sensor</b> Sensor to detect the room temperature at remote positions.	
<b>PAC-715AD Remote On/Off Adapter</b> Connector for receiving signals from the local system to control the on/off function.	
<b>Remote Operation Adapter</b> Adapter to display the operation status and control on/off function from a distance.	
<b>PAC-725AD Connector Plug for Remote Display</b> Connector used to display the operation status and control on/off function from a distance.	
<b>Distribution Pipe</b> Branch pipe for P Series simultaneous multi-system use, or to connect two branch boxes for MXZ.	 <p>*P Series with 2 indoor units</p>
<b>Joint Pipe</b> Part for connecting refrigerant pipes of different diameters.	
<b>Branch Box Outer Cover</b> Casement for branch boxes.	

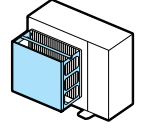
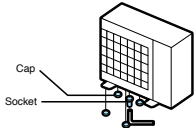
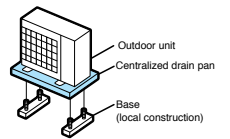
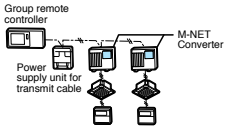
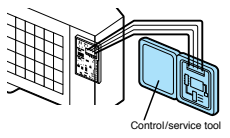
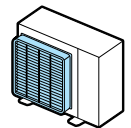
Part Name	Description
<b>Air Protection Guide/Wind Baffle</b> Protects the outdoor unit from the wind.	
<b>Drain Socket</b> A set of caps to cover unnecessary holes at the bottom of the outdoor unit, and a socket to guide drain water to the local drain pipe.	
<b>Centralized Drain Pan</b> Catches drain water generated by the outdoor unit.	
<b>M-NET Converter</b> Used to connect P Series A-control models to M-NET controllers.	
<b>Control/Service Tool</b> Monitoring tool to display operation and self-diagnosis data.	
<b>Air Discharge Guide</b> Changes the direction of air being exhausted from the outdoor unit.	

# Optional Parts List for Indoor [Nv-Series]

			Wall Mount								
			WPH					MSZ-EF			
			06	09	12	15	18	09NAW (B)(S)	12W (B)(S)	15W (B)(S)	18W (B)(S)
Filter	Deodorizing Filter	MAC-3000FT-E	•	•	•	•	•				
	Anti-allergy Enzyme Filter	MAC-408FT-E									
	Anti-allergy Enzyme Filter	MAC-1415FT-E									
	Electrostatic Anti-allergy Enzyme Filter	MAC-2330FT-E	•	•	•	•	•				
	Electrostatic Anti-allergy Enzyme Filter	MAC-2320FT-E						•	•	•	•
	Electrostatic Anti-allergy Enzyme Filter	MAC-2310FT-E									
	High Efficiency (MERV 8) Filter Element	PAC-SE81KF-E									
	High-efficiency Filter Element	PAC-SH59KF-E									
	High-efficiency Filter Element	PAC-SH89KF-E									
High-efficiency Filter Element	PAC-SH90KF-E										
Filter Box	Filter Box with MERV 8 Filters	FBL 1-1									
	Filter Box with MERV 8 Filters	FBL 1-2									
	Filter Box with MERV 8 Filters	FBL 1-3									
	Filter Box with MERV 13 Filters	FBM2-2-A									
	Filter Box with MERV 13 Filters	FBM2-3-A									
	Filter Box with MERV 13 Filters	FBM2-4-A									
Grille	Grille (required)	TLP-444W									
	Grille (required)	SLP-15AAUW									
	Grille (required)	TLP-18FAU									
i-see Sensor Panel	i-see Sensor™	PAC-SH91MK-E									
	3D i-see Sensor® Corner Panel	PAC-SF1ME-E									
	Grille with 3D i-see Sensor®	TLP-18FAEU									
	Grille with 3D i-see Sensor®	PLP-40EAU									
Casement	Multi-function Casement	PAC-SJ41TM-E									
	Installation/Trim Panels	PLFY-ITP1									
Space Panel	Installation/Trim Panels	PLFY-ITP2									
	Space Panel	PAC-SJ38AS-E									
	Shutter Plate	PAC-SJ37SP-E									
Bottom Return Plate	Converts low-profile ducted unit from rear to bottom	BRP-1									
	Converts low-profile ducted unit from rear to bottom	BRP-2									
	Converts low-profile ducted unit from rear to bottom	BRP-3									
Drain Pump	External Drain Pump	PAC-KE07DM-E									
	External Drain Pump	PAC-SH94DM-E									
	External Drain Pump	PAC-SH75DM-E									
	External Drain Pump	PAC-SH84DM-E									
Condensate	Blue Diamond Sensor Extension Cable—15 Ft.	C13-103	•	•	•	•	•	•	•	•	•
	Blue Diamond Alarm Extension Cable—6.5 Ft.	C13-192	•	•	•	•	•	•	•	•	•
	Blue Diamond MultiTank—collection tank for use with multiple pumps	C21-014	•	•	•	•	•	•	•	•	•
	Blue Diamond Rubber Foot Pads	F10-010	•	•	•	•	•	•	•	•	•
	Mini Condensate Pump—230 volt application	SI30-230	•	•	•	•	•	•	•	•	•
	MegaBlue Advanced Blue Diamond Condensate Pump w/ Reservoir & Sensor	X87-835 - 110 to 250V	•	•	•	•	•	•	•	•	•
	MaxiBlue Advanced Blue Diamond Mini Condensate Pump w/ Reservoir & Sensor (110V) up to 48,000 BTU/H [recommended]	X87-711 - 110V	•	•	•	•	•	•	•	•	•
	Advanced Blue Diamond Mini Condensate Pump w/ Reservoir & Sensor (208/230V) [recommended]	X87-721 - 208/230V	•	•	•	•	•	•	•	•	•
	MicroBlue Blue Diamond Mini Condensate Pump (110/208/230V) up to 18,000 BTU/H	X85-003	•	•	•	•	•	•	•	•	•
Fascia Kit for MicroBlue Pump, mounts the MicroBlue and sensor directly beneath indoor unit	T18-016	•	•	•	•	•	•	•	•	•	
Disconnect Switch	Drain Pan Level Sensor	SS610E	•	•	•	•	•	•	•	•	•
	(30A/600V/UL) [fits 2" X 4" utility box] - Black	TAZ-MS303	•	•	•	•	•	•	•	•	•
Terminal Block	(30A/600V/UL) [fits 2" X 4" utility box] - White	TAZ-MS303W	•	•	•	•	•	•	•	•	•
	Separate Power Terminal Block Kit	SPTB1									
Electric Heat Lockout	Electric Heat Lockout Control	ETC-211000-MIT									
Downflow Kit	Downflow Kit	DFK-S									
	Downflow Kit	DFK-M									
	Condensate Mgmt. Kit for downflow installation	CMA-1									
Electric Kit Heats	3kW Electric Heater	EH03-MPA-S(B)									
	5kW Electric Heater	EH05-MPA-S(B)									
	8kW Electric Heater	EH08-MPA-S(B)									
	3kW Electric Heater	EH03-MPA-M(B)									
	5kW Electric Heater	EH05-MPA-M(B)									
	8kW Electric Heater	EH08-MPA-M(B)									
	3kW Electric Heater	EH03-SVZ-S									
	5kW Electric Heater	EH05-SVZ-S									
	8kW Electric Heater	EH08-SVZ-S									
	5kW Electric Heater	EH05-SVZ-M									
	8kW Electric Heater	EH08-SVZ-M									
	10kW Electric Heater	EH10-SVZ-M									
	10kW Electric Heater	EH10-MPA-M(B)									
	10kW Electric Heater	EH10-MPA-L(B)									
15kW Electric Heater	EH15-MPAS- L(B)										
17kW Electric Heater	EH17- MPAS-L(B)										
Floor Mount Air Guide	Guides air flow for floor mount model when a concealer is used to hide the floor mount.	MAC-760FD-E									

Wall Mount																											
WST Heat Pump								WMT					WMT 115V		WEL				WST Cooling Only								
06	09	12	15	18	24	30	36	09	12	15	18	24	09	12	09	12	18	24	09	12	15	18	24	30	36		
•	•	•	•	•				•	•	•	•	•	•	•	•	•	•	•	•	•	•	•					
						•	•																		•	•	
					•																				•		

# Optional Parts List for Indoor [Nv-Series]

			Floor Mount				EZ FIT™		
			FKS				UKS		
			09	12	15	18	09	12	18
Filter	Deodorizing Filter	MAC-3000FT-E							
	Anti-allergy Enzyme Filter	MAC-408FT-E	•	•	•	•	•	•	•
	Anti-allergy Enzyme Filter	MAC-1415FT-E							
	Electrostatic Anti-allergy Enzyme Filter	MAC-2330FT-E							
	Electrostatic Anti-allergy Enzyme Filter	MAC-2320FT-E							
	Electrostatic Anti-allergy Enzyme Filter	MAC-2310FT-E							
	High Efficiency (MERV 8) Filter Element	PAC-SE81KF-E							
	High-efficiency Filter Element	PAC-SH59KF-E							
Filter Box	High-efficiency Filter Element	PAC-SH89KF-E							
	High-efficiency Filter Element	PAC-SH90KF-E							
	Filter Box with MERV 8 Filters	FBL 1-1							
	Filter Box with MERV 8 Filters	FBL 1-2							
	Filter Box with MERV 8 Filters	FBL 1-3							
	Filter Box with MERV 13 Filters	FBM2-2-A							
Grille	Filter Box with MERV 13 Filters	FBM2-3-A							
	Filter Box with MERV 13 Filters	FBM2-4-A							
	Grille (required)	TLP-444W					•	•	•
i-see Sensor Panel	Grille (required)	SLP-15AAUW							
	Grille (required)	TLP-18FAU							
	i-see Sensor™	PAC-SH91MK-E							
	3D i-see Sensor® Corner Panel	PAC-SF1ME-E							
Casement	Grille with 3D i-see Sensor®	TLP-18FAEU							
	Grille with 3D i-see Sensor®	PLP-40EAU							
Space Panel	Multi-function Casement	PAC-SJ41TM-E							
	Installation/Trim Panels	PLFY-ITP1							
Shutter Plate	Installation/Trim Panels	PLFY-ITP2							
	Space Panel	PAC-SJ38AS-E							
Bottom Return Plate	Shutter Plate	PAC-SJ37SP-E							
	Converts low-profile ducted unit from rear to bottom	BRP-1							
	Converts low-profile ducted unit from rear to bottom	BRP-2							
Drain Pump	Converts low-profile ducted unit from rear to bottom	BRP-3							
	External Drain Pump	PAC-KE07DM-E							
	External Drain Pump	PAC-SH94DM-E							
	External Drain Pump	PAC-SH75DM-E							
Condensate	External Drain Pump	PAC-SH84DM-E							
	Blue Diamond Sensor Extension Cable—15 Ft.	C13-103	•	•	•	•			
	Blue Diamond Alarm Extension Cable—6.5 Ft.	C13-192	•	•	•	•			
	Blue Diamond MultiTank—collection tank for use with multiple pumps	C21-014	•	•	•	•			
	Blue Diamond Rubber Foot Pads	F10-010	•	•	•	•			
	Mini Condensate Pump—230 volt application	SI30-230	•	•	•	•			
	MegaBlue Advanced Blue Diamond Condensate Pump w/ Reservoir & Sensor	X87-835 - 110 to 250V	•	•	•	•	•	•	•
	MaxiBlue Advanced Blue Diamond Mini Condensate Pump w/ Reservoir & Sensor (110V) up to 48,000 BTU/H [recommended]	X87-711 - 110V	•	•	•	•	•	•	•
	Advanced Blue Diamond Mini Condensate Pump w/ Reservoir & Sensor (208/230V) [recommended]	X87-721 - 208/230V	•	•	•	•	•	•	•
	MicroBlue Blue Diamond Mini Condensate Pump (110/208/230V) up to 18,000 BTU/H	X85-003							
Disconnect Switch	Fascia Kit for MicroBlue Pump, mounts the MicroBlue and sensor directly beneath indoor unit	T18-016							
	Drain Pan Level Sensor	SS610E	•	•	•	•			
Terminal Block	(30A/600V/UL) [fits 2" X 4" utility box] - Black	TAZ-MS303	•	•	•	•	•	•	•
	(30A/600V/UL) [fits 2" X 4" utility box] - White	TAZ-MS303W	•	•	•	•	•	•	•
Electric Heat Lockout	Separate Power Terminal Block Kit	SPTB1							
	Electric Heat Lockout Control	ETC-211000-MIT							
Downflow Kit	Downflow Kit	DFK-S							
	Downflow Kit	DFK-M							
Electric Kit Heats	Condensate Mgmt. Kit for downflow installation	CMA-1							
	3kW Electric Heater	EH03-MPA-S(B)							
	5kW Electric Heater	EH05-MPA-S(B)							
	8kW Electric Heater	EH08-MPA-S(B)							
	3kW Electric Heater	EH03-MPA-M(B)							
	5kW Electric Heater	EH05-MPA-M(B)							
	8kW Electric Heater	EH08-MPA-M(B)							
	3kW Electric Heater	EH03-SVZ-S							
	5kW Electric Heater	EH05-SVZ-S							
	8kW Electric Heater	EH08-SVZ-S							
	5kW Electric Heater	EH05-SVZ-M							
	8kW Electric Heater	EH08-SVZ-M							
	10kW Electric Heater	EH10-SVZ-M							
	10kW Electric Heater	EH10-MPA-M(B)							
	10kW Electric Heater	EH10-MPA-L(B)							
	15kW Electric Heater	EH15-MPAS- L(B)							
	17kW Electric Heater	EH17- MPAS-L(B)							
Floor Mount Air Guide	Guides air flow for floor mount model when a concealer is used to hide the floor mount.	MAC-760FD-E	•	•	•	•			





# Optional Parts List for Indoor [P-Series]

			Wall Mount					Ceiling-suspended				
			PKA					PCA-				
			A12HA7	A18HA7	A24KA7	A30KA7	A36KA7	A24KA7	A30KA7	A36KA7	A42KA7	
Filter	Deodorizing Filter	MAC-3000FT-E										
	Anti-allergy Enzyme Filter	MAC-408FT-E										
	Anti-allergy Enzyme Filter	MAC-1415FT-E										
	Electrostatic Anti-allergy Enzyme Filter	MAC-2330FT-E										
	Electrostatic Anti-allergy Enzyme Filter	MAC-2320FT-E										
	Electrostatic Anti-allergy Enzyme Filter	MAC-2310FT-E										
	High Efficiency (MERV 8) Filter Element	PAC-SE81KF-E						•	•	•	•	
	High-efficiency Filter Element	PAC-SH59KF-E										
Filter Box	High-efficiency Filter Element	PAC-SH89KF-E						•	•			
	High-efficiency Filter Element	PAC-SH90KF-E								•	•	
	Filter Box with MERV 8 Filters	FBL 1-1										
	Filter Box with MERV 8 Filters	FBL 1-2										
	Filter Box with MERV 8 Filters	FBL 1-3										
	Filter Box with MERV 13 Filters	FBM2-2-A										
Grille	Filter Box with MERV 13 Filters	FBM2-3-A										
	Filter Box with MERV 13 Filters	FBM2-4-A										
	Grille (required)	TLP-444W										
i-see Sensor Panel	Grille (required)	SLP-15AAUW										
	Grille (required)	TLP-18FAU										
	i-see Sensor™	PAC-SH91MK-E						•	•	•	•	
	3D i-see Sensor® Corner Panel	PAC-SF1ME-E										
Casement	Grille with 3D i-see Sensor®	TLP-18FAEU										
	Grille with 3D i-see Sensor®	PLP-40AEU										
Space Panel	Multi-function Casement	PAC-SJ41TM-E										
	Installation/Trim Panels	PLFY-ITP1										
	Installation/Trim Panels	PLFY-ITP2										
Shutter Plate	Space Panel	PAC-SJ38AS-E										
	Shutter Plate	PAC-SJ37SP-E										
Bottom Return Plate	Converts low-profile ducted unit from rear to bottom	BRP-1										
	Converts low-profile ducted unit from rear to bottom	BRP-2										
	Converts low-profile ducted unit from rear to bottom	BRP-3										
Drain Pump	External Drain Pump	PAC-KE07DM-E										
	External Drain Pump	PAC-SH94DM-E			•	•	•					
	External Drain Pump	PAC-SH75DM-E	•	•								
	External Drain Pump	PAC-SH84DM-E					•	•	•	•		
Condensate	Blue Diamond Sensor Extension Cable—15 Ft.	C13-103	•	•	•	•	•	•	•	•	•	
	Blue Diamond Alarm Extension Cable—6.5 Ft.	C13-192										
	Blue Diamond MultiTank—collection tank for use with multiple pumps	C21-014										
	Blue Diamond Rubber Foot Pads	F10-010										
	Mini Condensate Pump—230 volt application	SI30-230	•	•	•	•	•					
	MegaBlue Advanced Blue Diamond Condensate Pump w/ Reservoir & Sensor	X87-835 - 110 to 250V	•	•	•	•	•	•	•	•	•	
	MaxiBlue Advanced Blue Diamond Mini Condensate Pump w/ Reservoir & Sensor (110V) up to 48,000 BTU/H [recommended]	X87-711 - 110V										
	Advanced Blue Diamond Mini Condensate Pump w/ Reservoir & Sensor (208/230V) [recommended]	X87-721 - 208/230V	•	•	•	•	•	•	•	•	•	
	MicroBlue Blue Diamond Mini Condensate Pump (110/208/230V) up to 18,000 BTU/H	X85-003	•	•								
	Fascia Kit for MicroBlue Pump, mounts the MicroBlue and sensor directly beneath indoor unit	T18-016	•	•								
Disconnect Switch	Drain Pan Level Sensor	SS610E	•	•	•	•	•					
	(30A/600V/UL) [fits 2" X 4" utility box] - Black	TAZ-MS303	•	•	•	•	•	•	•	•	•	
Terminal Block	(30A/600V/UL) [fits 2" X 4" utility box] - White	TAZ-MS303W	•	•	•	•	•	•	•	•	•	
	Separate Power Terminal Block Kit	SPTB1										
Downflow Kit	Electric Heat Lockout Control	ETC-211000-MIT										
	Downflow Kit	DFK-S										
Electric Kit Heats	Downflow Kit	DFK-M										
	Condensate Mgmt. Kit for downflow installation	CMA-1										
	3kW Electric Heater	EH03-MPA-S(B)										
	5kW Electric Heater	EH05-MPA-S(B)										
	8kW Electric Heater	EH08-MPA-S(B)										
	3kW Electric Heater	EH03-MPA-M(B)										
	5kW Electric Heater	EH05-MPA-M(B)										
	8kW Electric Heater	EH08-MPA-M(B)										
	3kW Electric Heater	EH03-SVZ-S										
	5kW Electric Heater	EH05-SVZ-S										
	8kW Electric Heater	EH08-SVZ-S										
	5kW Electric Heater	EH05-SVZ-M										
	8kW Electric Heater	EH08-SVZ-M										
	10kW Electric Heater	EH10-SVZ-M										
	10kW Electric Heater	EH10-MPA-M(B)										
	10kW Electric Heater	EH10-MPA-L(B)										
	Floor Mount Air Guide	15kW Electric Heater	EH15-MPAS- L(B)									
17kW Electric Heater		EH17- MPAS-L(B)										
	Guides air flow for floor mount model when a concealer is used to hide the floor mount.	MAC-760FD-E										

\*1 2 pieces required. \*2 PEAD12/SUZ-KA12NAR1



# Optional Parts List for Outdoor [Nv-Series]

			SPH					SPB		
			06	09	12	15	18	06	09	12
Distribution pipe	Twinning Distribution Pipe (50:50)	MSDD-50TR-E								
Distribution pipe	Flare Connection	MSDD-50AR-E								
Distribution pipe for Branch box	Brazed	MSDD-50BR-E								
Port Adapter	Port Adapter size: 3/8" x 5/8"	PAC-SG76RJ-E								
	Port Adapter size: 1/4" x 3/8"	PAC-493PI								
	Port Adapter size: 3/8" X 1/2"	MAC-A454JP-E								
	Port Adapter size: 1/2" X 3/8"	MAC-A455JP-E								
	Port Adapter size: 1/2" X 5/8"	MAC-A456JP-E								
Branch Box	Port Adapter size: 5/8" x 3/4"	ADP5834								
	Branch Box	TAC-MKA51BC								
	Branch Box	TAC-MKA31BC								
Air Outlet Guide	Branch Box Outer Cover	BBE-1								
	Air Outlet Guide	MAC-881SG	•	•	•			•	•	•
	Air Outlet Guide	MAC-886SG-E				•	•			
	Air Outlet Guide	MAC-856SG								
	Air Outlet Guide	PAC-SH96SG-E								
Front Wind Baffle	Air Outlet Guide	PAC-SJ07SG-E								
	Air Outlet Guide	PAC-SG59SG-E								
	Front Wind Baffle	WB-PA3								
Rear Advanced Wind Baffle	Front Wind Baffle	WB-PA4								
	Front Wind Baffle	WB-PA5								
	Front Wind Baffle	WB-RE4								
Side Advanced Wind Baffle	Rear Advanced Wind Baffle	WB-RE5								
	Rear Advanced Wind Baffle	WB-RE6								
	Rear Advanced Wind Baffle	WB-SD4								
Drain Socket	Side Advanced Wind Baffle	WB-SD5								
	Side Advanced Wind Baffle	WB-SD6								
	Drain Socket (1st-gen)	PAC-SF37DS-E								
Optional Defrost Heater	Drain Socket	PAC-SG60DS-E								
	Drain Socket	PAC-SG61DS-E								
	Drain Socket	MAC-860DS	•	•	•	•	•			
	Drain Socket	MAC-811DS								
	Drain Socket	MAC-851DS								
	Drain Socket (6-gen)	PAC-SH71DS-E								
	Drain Socket	PAC-SJ08DS-E								
Centralized Drain Pan	Optional Defrost Heater	MAC-640BH-U	•	•	•					
	Optional Defrost Heater	MAC-641BH-U								
	Optional Defrost Heater	MAC-642BH-U1				•	•			
	Optional Defrost Heater	PAC-645BH-E								
	Optional Defrost Heater	PAC-646BH-E								
M-NET Converter	Optional Defrost Heater	PAC-SJ20BH-E								
	Centralized Drain Pan	PAC-SH97DP-E								
	Centralized Drain Pan	PAC-SG63DP-E								
Control/Service Tool	Centralized Drain Pan	PAC-SG64DP-E								
	M-NET Converter	PAC-IF01MNT-E								
	M-NET Converter	PAC-SJ19MA-E								
	M-NET Converter	PAC-SJ85MA-E								
Ball Valve	M-NET Converter	PAC-SJ96MA-E								
	M-NET Converter	PAC-SJ95MA-E								
	Control/Service Tool	PAC-SK52ST								
	Refrigeration Ball Valve-Flare/Schrader/Insulated—1/2" size	BV12FFSI2								
	Refrigeration Ball Valve-Flare/Schrader/Insulated—1/4" size	BV14FFSI2								
Hail Guards	Refrigeration Ball Valve-Flare/Schrader/Insulated—3/8" size	BV38FFSI2								
	Refrigeration Ball Valve-Flare/Schrader/Insulated—5/8" size	BV58FFSI2								
	Hail Guard	HG-A1								
	Hail Guard	HG-A2								
	Hail Guard	HG-A3								
	Hail Guard	HG-B4	•	•	•			•	•	•
	Hail Guard	HG-A5								
	Hail Guard	HG-A6								
	Hail Guard	HG-A7				•	•			
Outdoor Unit Mounting Pad	Hail Guard	HG-A8								
	Hail Guard	HG-A9								
	Outdoor Unit 3-1/4 inch Mounting Base (Pair) - Plastic	DSD-400P	•	•	•	•	•	•	•	•
Outdoor Unit Stand	Condensing Unit Mounting Pad 16" x 36" x 3"	ULTRILITE1	•	•	•	•	•	•	•	•
	Condensing Unit Mounting Pad 24" x 42" x 3"	ULTRILITE2	•	•	•	•	•	•	•	•
	Outdoor Unit Stand—12" High	QSMS1201M	•	•	•	•	•	•	•	•
	Outdoor Unit Stand—18" High	QSMS1801M	•	•	•	•	•	•	•	•
	Outdoor Unit Stand—24" High	QSMS2401M	•	•	•	•	•	•	•	•
Lineset	Outdoor Unit Stand—12" High	QSMS1202M								
	Outdoor Unit Stand—18" High	QSMS1802M								
	Outdoor Unit Stand—24" High	QSMS2402M								
	Heavy Duty Wall Mounting Bracket—Coated Steel	QSWB2000M-1	•	•	•	•	•	•	•	•
	Heavy Duty Wall Mounting Bracket—316 Series Stainless Steel	QSWBSS	•	•	•	•	•	•	•	•
	15' x 1/4" x 15' / 3/8" Lineset (Twin-Tube Insulation)	MLS143812T-15	•	•	•			•	•	•
	30' x 1/4" x 30' / 3/8" Lineset (Twin-Tube Insulation)	MLS143812T-30	•	•	•			•	•	•
	50' x 1/4" x 50' / 3/8" Lineset (Twin-Tube Insulation)	MLS143812T-50	•	•	•			•	•	•
	65' x 1/4" x 65' / 3/8" Lineset (Twin-Tube Insulation)	MLS143812T-65	•	•	•			•	•	•
	15' x 1/4" x 15' / 1/2" Lineset (Twin-Tube Insulation)	MLS141212T-15				•	•			
	30' x 1/4" x 30' / 1/2" Lineset (Twin-Tube Insulation)	MLS141212T-30				•	•			
	50' x 1/4" x 50' / 1/2" Lineset (Twin-Tube Insulation)	MLS141212T-50				•	•			
	65' x 1/4" x 65' / 1/2" Lineset (Twin-Tube Insulation)	MLS141212T-65				•	•			
	100' x 1/4" x 100' / 1/2" Lineset (Twin-Tube Insulation)	MLS141212T-100				•	•			
	10' x 3/8" x 10' x 5/8" Lineset (Twin-Tube Insulation)	MPLS385812T-10								
15' x 3/8" x 15' x 5/8" Lineset (Twin-Tube Insulation)	MPLS385812T-15									
30' x 3/8" x 30' x 5/8" Lineset (Twin-Tube Insulation)	MPLS385812T-30									
50' x 3/8" x 50' x 5/8" Lineset (Twin-Tube Insulation)	MPLS385812T-50									
65' x 3/8" x 65' x 5/8" Lineset (Twin-Tube Insulation)	MPLS385812T-65									
100' x 3/8" x 100' x 5/8" Lineset (Twin-Tube Insulation)	MPLS385812T-100									
15' x 3/8" x 15' / 3/4" Lineset (Twin-Tube Insulation)	MPLS383412T-15									
50' x 3/8" x 50' / 3/4" Lineset (Twin-Tube Insulation)	MPLS383412T-50									

\*1 2 pieces required, \*2 PEAD12/SUZ-KA12NAR



# Optional Parts List for Outdoor [Nv-Series]

			SST Cooling Only		SPF				SMT 115V	
			30	36	09	12	15	18	09	12
Distribution pipe	Twinning Distribution Pipe (50:50)	MSDD-50TR-E								
Distribution pipe for Branch box	Flare Connection Braze	MSDD-50AR-E MSDD-50BR-E								
Port Adapter	Port Adapter size: 3/8" x 5/8"	PAC-SG76RJ-E								
	Port Adapter size: 1/4" x 3/8"	PAC-493PI								
	Port Adapter size: 3/8" X 1/2"	MAC-A454JP-E								
	Port Adapter size: 1/2" X 3/8"	MAC-A455JP-E								
	Port Adapter size: 1/2" X 5/8"	MAC-A456JP-E								
	Port Adapter size: 5/8" x 3/4"	ADP5834								
Branch Box	Branch Box	TAC-MKA51BC								
	Branch Box	TAC-MKA31BC								
	Branch Box Outer Cover	BBE-1								
Air Outlet Guide	Air Outlet Guide	MAC-881SG			•	•			•	•
	Air Outlet Guide	MAC-886SG-E					•	•		
	Air Outlet Guide	MAC-856SG								
	Air Outlet Guide	PAC-SH96SG-E								
	Air Outlet Guide	PAC-SJ07SG-E								
	Air Outlet Guide	PAC-SG59SG-E								
Front Wind Baffle	Front Wind Baffle	WB-PA3								
	Front Wind Baffle	WB-PA4								
	Front Wind Baffle	WB-PA5								
Rear Advanced Wind Baffle	Rear Advanced Wind Baffle	WB-RE4								
	Rear Advanced Wind Baffle	WB-RE5								
	Rear Advanced Wind Baffle	WB-RE6								
Side Advanced Wind Baffle	Side Advanced Wind Baffle	WB-SD4								
	Side Advanced Wind Baffle	WB-SD5								
	Side Advanced Wind Baffle	WB-SD6								
Drain Socket	Drain Socket (1st-gen)	PAC-SF37DS-E								
	Drain Socket	PAC-SG60DS-E								
	Drain Socket	PAC-SG61DS-E								
	Drain Socket	MAC-860DS							•	•
	Drain Socket	MAC-811DS	•	•						
	Drain Socket	MAC-851DS								
	Drain Socket (6-gen)	PAC-SH71DS-E								
	Drain Socket	PAC-SJ08DS-E								
Optional Defrost Heater	Optional Defrost Heater	MAC-640BH-U								
	Optional Defrost Heater	MAC-641BH-U								
	Optional Defrost Heater	MAC-642BH-U1								
	Optional Defrost Heater	PAC-645BH-E								
	Optional Defrost Heater	PAC-646BH-E								
	Optional Defrost Heater	PAC-SJ20BH-E								
Centralized Drain Pan	Centralized Drain Pan	PAC-SH97DP-E								
	Centralized Drain Pan	PAC-SG63DP-E								
	Centralized Drain Pan	PAC-SG64DP-E								
M-NET Converter	M-NET Converter	PAC-IF01MNT-E								
	M-NET Converter	PAC-SJ19MA-E								
	M-NET Converter	PAC-SJ85MA-E								
	M-NET Converter	PAC-SJ96MA-E								
	M-NET Converter	PAC-SJ95MA-E								
Control/Service Tool	Control/Service Tool	PAC-SK52ST								
Ball Valve	Refrigeration Ball Valve-Flare/Schrader/Insulated—1/2" size	BV12FFS12								
	Refrigeration Ball Valve-Flare/Schrader/Insulated—1/4" size	BV14FFS12								
	Refrigeration Ball Valve-Flare/Schrader/Insulated—3/8" size	BV38FFS12								
	Refrigeration Ball Valve-Flare/Schrader/Insulated—5/8" size	BV58FFS12								
Hail Guards	Hail Guard	HG-A1								
	Hail Guard	HG-A2								
	Hail Guard	HG-A3								
	Hail Guard	HG-B4			•	•			•	•
	Hail Guard	HG-A5								
	Hail Guard	HG-A6								
	Hail Guard	HG-A7					•	•		
	Hail Guard	HG-A8								
	Hail Guard	HG-A9								
Outdoor Unit Mounting Pad	Outdoor Unit 3-1/4 inch Mounting Base (Pair) - Plastic	DSD-400P	•	•	•	•	•	•	•	•
	Condensing Unit Mounting Pad 16" x 36" x 3"	ULTRILITE1	•	•	•	•	•	•	•	•
	Condensing Unit Mounting Pad 24" x 42" x 3"	ULTRILITE2								
Outdoor Unit Stand	Outdoor Unit Stand—12" High	QSMS1201M	•	•	•	•	•	•	•	•
	Outdoor Unit Stand—18" High	QSMS1801M	•	•	•	•	•	•	•	•
	Outdoor Unit Stand—24" High	QSMS2401M	•	•	•	•	•	•	•	•
	Outdoor Unit Stand—12" High	QSMS1202M								
	Outdoor Unit Stand—18" High	QSMS1802M								
	Outdoor Unit Stand—24"High	QSMS2402M								
Wall Bracket	Heavy Duty Wall Mounting Bracket—Coated Steel	QSWB2000M-1	•	•	•	•	•	•	•	•
	Heavy Duty Wall Mounting Bracket—316 Series Stainless Steel	QSWBSS	•	•	•	•	•	•	•	•
Lineset	15' x 1/4" x 15' / 3/8" Lineset (Twin-Tube Insulation)	MLS143812T-15			•	•			•	•
	30' x 1/4" x 30' / 3/8" Lineset (Twin-Tube Insulation)	MLS143812T-30			•	•			•	•
	50' x 1/4" x 50' / 3/8" Lineset (Twin-Tube Insulation)	MLS143812T-50			•	•			•	•
	65' x 1/4" x 65' / 3/8" Lineset (Twin-Tube Insulation)	MLS143812T-65			•	•			•	•
	15' x 1/4" x 15' / 1/2" Lineset (Twin-Tube Insulation)	MLS141212T-15					•	•		
	30' x 1/4" x 30' / 1/2" Lineset (Twin-Tube Insulation)	MLS141212T-30					•	•		
	50' x 1/4" x 50' / 1/2" Lineset (Twin-Tube Insulation)	MLS141212T-50					•	•		
	65' x 1/4" x 65' / 1/2" Lineset (Twin-Tube Insulation)	MLS141212T-65					•	•		
	100' x 1/4" x 100' / 1/2" Lineset (Twin-Tube Insulation)	MLS141212T-100					•	•		
	10' x 3/8" x 10' x 5/8" Lineset (Twin-Tube Insulation)	MPLS385812T-10	•	•						
	15' x 3/8" x 15' x 5/8" Lineset (Twin-Tube Insulation)	MPLS385812T-15	•	•						
	30' x 3/8" x 30' x 5/8" Lineset (Twin-Tube Insulation)	MPLS385812T-30	•	•						
	50' x 3/8" x 50' x 5/8" Lineset (Twin-Tube Insulation)	MPLS385812T-50	•	•						
	65' x 3/8" x 65' x 5/8" Lineset (Twin-Tube Insulation)	MPLS385812T-65	•	•						
	100' x 3/8" x 100' x 5/8" Lineset (Twin-Tube Insulation)	MPLS385812T-100	•	•						
	15' x 3/8" x 15' / 3/4" Lineset (Twin-Tube Insulation)	MPLS383412T-15								
	50' x 3/8" x 50' / 3/4" Lineset (Twin-Tube Insulation)	MPLS383412T-50								

\*1 2 pieces required, \*2 PEAD12/SUZ-KA12NAR1





# Optional Parts List for Outdoor [Nv-Series]

			SKS		
			09	12	15
Distribution pipe	Twining Distribution Pipe (50:50)	MSDD-50TR-E			
Distribution pipe for Branch box	Flare Connection	MSDD-50AR-E			
	Brazed	MSDD-50BR-E			
Port Adapter	Port Adapter size: 3/8" x 5/8"	PAC-SG76RJ-E			
	Port Adapter size: 1/4" x 3/8"	PAC-493P1			
	Port Adapter size: 3/8" X 1/2"	MAC-A454JP-E			
	Port Adapter size: 1/2" X 3/8"	MAC-A455JP-E		•*2	
	Port Adapter size: 1/2" X 5/8"	MAC-A456JP-E			
	Port Adapter size: 5/8" x 3/4"	ADP5834			
Branch Box	Branch Box	TAC-MKA51BC			
	Branch Box	TAC-MKA31BC			
	Branch Box Outer Cover	BBE-1			
Air Outlet Guide	Air Outlet Guide	MAC-881SG	•	•	•
	Air Outlet Guide	MAC-886SG-E			
	Air Outlet Guide	MAC-856SG			
	Air Outlet Guide	PAC-SH96SG-E			
	Air Outlet Guide	PAC-SJ07SG-E			
	Air Outlet Guide	PAC-SG59SG-E			
Front Wind Baffle	Front Wind Baffle	WB-PA3			
	Front Wind Baffle	WB-PA4			
	Front Wind Baffle	WB-PA5			
Rear Advanced Wind Baffle	Rear Advanced Wind Baffle	WB-RE4			
	Rear Advanced Wind Baffle	WB-RE5			
	Rear Advanced Wind Baffle	WB-RE6			
Side Advanced Wind Baffle	Side Advanced Wind Baffle	WB-SD4			
	Side Advanced Wind Baffle	WB-SD5			
	Side Advanced Wind Baffle	WB-SD6			
Drain Socket	Drain Socket (1st-gen)	PAC-SF37DS-E			
	Drain Socket	PAC-SG60DS-E			
	Drain Socket	PAC-SG61DS-E			
	Drain Socket	MAC-860DS			
	Drain Socket	MAC-811DS			
	Drain Socket	MAC-851DS			
	Drain Socket (6-gen)	PAC-SH71DS-E			
	Drain Socket	PAC-SJ08DS-E			
Optional Defrost Heater	Optional Defrost Heater	MAC-640BH-U	•	•	•
	Optional Defrost Heater	MAC-641BH-U			
	Optional Defrost Heater	MAC-642BH-U1			
	Optional Defrost Heater	PAC-645BH-E			
	Optional Defrost Heater	PAC-646BH-E			
	Optional Defrost Heater	PAC-SJ20BH-E			
Centralized Drain Pan	Centralized Drain Pan	PAC-SH97DP-E			
	Centralized Drain Pan	PAC-SG63DP-E			
	Centralized Drain Pan	PAC-SG64DP-E			
M-NET Converter	M-NET Converter	PAC-IF01MNT-E			
	M-NET Converter	PAC-SJ19MA-E			
	M-NET Converter	PAC-SJ85MA-E			
	M-NET Converter	PAC-SJ96MA-E			
	M-NET Converter	PAC-SJ95MA-E			
Control/Service Tool	Control/Service Tool	PAC-SK52ST			
Ball Valve	Refrigeration Ball Valve-Flare/Schrader/Insulated— 1/2" size	BV12FFSI2			
	Refrigeration Ball Valve-Flare/Schrader/Insulated— 1/4" size	BV14FFSI2			
	Refrigeration Ball Valve-Flare/Schrader/Insulated— 3/8" size	BV38FFSI2			
	Refrigeration Ball Valve-Flare/Schrader/Insulated— 5/8" size	BV58FFSI2			
Hail Guards	Hail Guard	HG-A1			
	Hail Guard	HG-A2			
	Hail Guard	HG-A3			
	Hail Guard	HG-B4	•	•	•
	Hail Guard	HG-A5			
	Hail Guard	HG-A6			
	Hail Guard	HG-A7			
	Hail Guard	HG-A8			
	Hail Guard	HG-A9			
Outdoor Unit Mounting Pad	Outdoor Unit 3-1/4 inch Mounting Base (Pair) - Plastic	DSD-400P	•	•	•
	Condensing Unit Mounting Pad 16" x 36" x 3"	ULTRILITE1	•	•	•
	Condensing Unit Mounting Pad 24" x 42" x 3"	ULTRILITE2			
Outdoor Unit Stand	Outdoor Unit Stand— 12" High	QSMS1201M	•	•	•
	Outdoor Unit Stand— 18" High	QSMS1801M	•	•	•
	Outdoor Unit Stand— 24" High	QSMS2401M	•	•	•
	Outdoor Unit Stand— 12" High	QSMS1202M			
	Outdoor Unit Stand— 18" High	QSMS1802M			
	Outdoor Unit Stand— 24" High	QSMS2402M			
Wall Bracket	Heavy Duty Wall Mounting Bracket—Coated Steel	QSWB2000M-1	•	•	•
	Heavy Duty Wall Mounting Bracket—316 Series Stainless Steel	QSWBSS	•	•	•
Lineset	15' x 1/4" x 15' / 3/8" Lineset (Twin-Tube Insulation)	MLS143812T-15	•	•	•
	30' x 1/4" x 30' / 3/8" Lineset (Twin-Tube Insulation)	MLS143812T-30	•	•	•
	50' x 1/4" x 50' / 3/8" Lineset (Twin-Tube Insulation)	MLS143812T-50	•	•	•
	65' x 1/4" x 65' / 3/8" Lineset (Twin-Tube Insulation)	MLS143812T-65	•	•	•
	15' x 1/4" x 15' / 1/2" Lineset (Twin-Tube Insulation)	MLS141212T-15			
	30' x 1/4" x 30' / 1/2" Lineset (Twin-Tube Insulation)	MLS141212T-30			
	50' x 1/4" x 50' / 1/2" Lineset (Twin-Tube Insulation)	MLS141212T-50			
	65' x 1/4" x 65' / 1/2" Lineset (Twin-Tube Insulation)	MLS141212T-65			
	100' x 1/4" x 100' / 1/2" Lineset (Twin-Tube Insulation)	MLS141212T-100			
	10' x 3/8" x 10' x 5/8" Lineset (Twin-Tube Insulation)	MPLS385812T-10			
	15' x 3/8" x 15' x 5/8" Lineset (Twin-Tube Insulation)	MPLS385812T-15			
	30' x 3/8" x 30' x 5/8" Lineset (Twin-Tube Insulation)	MPLS385812T-30			
	50' x 3/8" x 50' x 5/8" Lineset (Twin-Tube Insulation)	MPLS385812T-50			
	65' x 3/8" x 65' x 5/8" Lineset (Twin-Tube Insulation)	MPLS385812T-65			
	100' x 3/8" x 100' x 5/8" Lineset (Twin-Tube Insulation)	MPLS385812T-100			
	15' x 3/8" x 15' / 3/4" Lineset (Twin-Tube Insulation)	MPLS383412T-15			
	50' x 3/8" x 50' / 3/4" Lineset (Twin-Tube Insulation)	MPLS383412T-50			

\*1 2 pieces required, \*2 PEAD12/SUZ-KA12NAR1



# Optional Parts List for Outdoor [P-Series]

			PUY-A					
			12NKA7 (-BS)	18NKA7 (-BS)	24NHA7 (-BS)	30NHA7 (-BS)	36NKA7 (-BS)	42NKA7 (-BS)
Distribution pipe	Twinning Distribution Pipe (50:50)	MSDD-50TR-E			•		•	
Distribution pipe for Branch box	Flare Connection	MSDD-50AR-E						
	Brazed	MSDD-50BR-E						
Port Adapter	Port Adapter size: 3/8" x 5/8"	PAC-SG76RJ-E						
	Port Adapter size: 1/4" x 3/8"	PAC-493PI						
	Port Adapter size: 3/8" X 1/2"	MAC-A454JP-E						
	Port Adapter size: 1/2" X 3/8"	MAC-A455JP-E						
	Port Adapter size: 1/2" X 5/8"	MAC-A456JP-E						
	Port Adapter size: 5/8" x 3/4"	ADP5834						
Branch Box	Branch Box	TAC-MKA51BC						
	Branch Box	TAC-MKA31BC						
Branch Box Outer Cover		BBE-1						
Air Outlet Guide	Air Outlet Guide	MAC-881SG						
	Air Outlet Guide	MAC-886SG-E						
	Air Outlet Guide	MAC-856SG						
	Air Outlet Guide	PAC-SH96SG-E					•*1	•*1
	Air Outlet Guide	PAC-SJ07SG-E	•	•				
	Air Outlet Guide	PAC-SG59SG-E			•	•		
Front Wind Baffle	Front Wind Baffle	WB-PA3					•*1	•*1
	Front Wind Baffle	WB-PA4	•	•				
	Front Wind Baffle	WB-PA5			•	•		
Rear Advanced Wind Baffle	Rear Advanced Wind Baffle	WB-RE4	•	•				
	Rear Advanced Wind Baffle	WB-RE5			•	•		
	Rear Advanced Wind Baffle	WB-RE6					•	•
Side Advanced Wind Baffle	Side Advanced Wind Baffle	WB-SD4	•	•				
	Side Advanced Wind Baffle	WB-SD5			•	•		
	Side Advanced Wind Baffle	WB-SD6					•	•
Drain Socket	Drain Socket (1st-gen)	PAC-SF37DS-E						
	Drain Socket	PAC-SG60DS-E						
	Drain Socket	PAC-SG61DS-E			•	•	•	•
	Drain Socket	MAC-860DS						
	Drain Socket	MAC-811DS						
	Drain Socket	MAC-851DS						
	Drain Socket (6-gen)	PAC-SH71DS-E						
Drain Socket	PAC-SJ08DS-E	•	•					
Optional Defrost Heater	Optional Defrost Heater	MAC-640BH-U						
	Optional Defrost Heater	MAC-641BH-U						
	Optional Defrost Heater	MAC-642BH-U1						
	Optional Defrost Heater	PAC-645BH-E						
	Optional Defrost Heater	PAC-646BH-E						
Centralized Drain Pan	Centralized Drain Pan	PAC-SH97DP-E					•	•
	Centralized Drain Pan	PAC-SG63DP-E	•	•				
	Centralized Drain Pan	PAC-SG64DP-E			•	•		
M-NET Converter	M-NET Converter	PAC-IF01MNT-E						
	M-NET Converter	PAC-SJ19MA-E	•	•				
	M-NET Converter	PAC-SJ85MA-E			•	•	•	•
	M-NET Converter	PAC-SJ96MA-E	•	•				
	M-NET Converter	PAC-SJ95MA-E			•	•	•	•
Control/Service Tool	Control/Service Tool	PAC-SK52ST	•	•	•	•	•	•
Ball Valve	Refrigeration Ball Valve-Flare/Schrader/Insulated—1/2" size	BV12FFSI2						
	Refrigeration Ball Valve-Flare/Schrader/Insulated—1/4" size	BV14FFSI2						
	Refrigeration Ball Valve-Flare/Schrader/Insulated—3/8" size	BV38FFSI2						
	Refrigeration Ball Valve-Flare/Schrader/Insulated—5/8" size	BV58FFSI2						
Hail Guards	Hail Guard	HG-A1						
	Hail Guard	HG-A2					•	•
	Hail Guard	HG-A3						
	Hail Guard	HG-B4						
	Hail Guard	HG-A5	•	•				
	Hail Guard	HG-A6			•	•		
	Hail Guard	HG-A7						
	Hail Guard	HG-A8						
	Hail Guard	HG-A9						
Outdoor Unit Mounting Pad	Outdoor Unit 3-1/4 inch Mounting Base (Pair) - Plastic	DSD-400P						
	Condensing Unit Mounting Pad 16" x 36" x 3"	ULTRILITE1	•	•				
	Condensing Unit Mounting Pad 24" x 42" x 3"	ULTRILITE2			•	•	•	•
Outdoor Unit Stand	Outdoor Unit Stand—12" High	QSMS1201M	•	•	•	•		
	Outdoor Unit Stand—18" High	QSMS1801M	•	•	•	•		
	Outdoor Unit Stand—24" High	QSMS2401M	•	•	•	•		
	Outdoor Unit Stand—12" High	QSMS1202M					•	•
	Outdoor Unit Stand—18" High	QSMS1802M					•	•
	Outdoor Unit Stand—24" High	QSMS2402M					•	•
Wall Bracket	Heavy Duty Wall Mounting Bracket—Coated Steel	QSWB2000M-1	•	•	•	•	•	•
	Heavy Duty Wall Mounting Bracket—316 Series Stainless Steel	QSWBSS	•	•	•	•	•	•
Lineset	15' x 1/4" x 15' / 3/8" Lineset (Twin-Tube Insulation)	MLS143812T-15						
	30' x 1/4" x 30' / 3/8" Lineset (Twin-Tube Insulation)	MLS143812T-30						
	50' x 1/4" x 50' / 3/8" Lineset (Twin-Tube Insulation)	MLS143812T-50						
	65' x 1/4" x 65' / 3/8" Lineset (Twin-Tube Insulation)	MLS143812T-65						
	15' x 1/4" x 15' / 1/2" Lineset (Twin-Tube Insulation)	MLS141212T-15	•	•				
	30' x 1/4" x 30' / 1/2" Lineset (Twin-Tube Insulation)	MLS141212T-30	•	•				
	50' x 1/4" x 50' / 1/2" Lineset (Twin-Tube Insulation)	MLS141212T-50	•	•				
	65' x 1/4" x 65' / 1/2" Lineset (Twin-Tube Insulation)	MLS141212T-65	•	•				
	100' x 1/4" x 100' / 1/2" Lineset (Twin-Tube Insulation)	MLS141212T-100	•	•				
	10' x 3/8" x 10' x 5/8" Lineset (Twin-Tube Insulation)	MPLS385812T-10			•	•	•	•
	15' x 3/8" x 15' x 5/8" Lineset (Twin-Tube Insulation)	MPLS385812T-15			•	•	•	•
	30' x 3/8" x 30' x 5/8" Lineset (Twin-Tube Insulation)	MPLS385812T-30			•	•	•	•
	50' x 3/8" x 50' x 5/8" Lineset (Twin-Tube Insulation)	MPLS385812T-50			•	•	•	•
	65' x 3/8" x 65' x 5/8" Lineset (Twin-Tube Insulation)	MPLS385812T-65			•	•	•	•
	100' x 3/8" x 100' x 5/8" Lineset (Twin-Tube Insulation)	MPLS385812T-100			•	•	•	•
	15' x 3/8" x 15' / 3/4" Lineset (Twin-Tube Insulation)	MPLS383412T-15						
	50' x 3/8" x 50' / 3/4" Lineset (Twin-Tube Insulation)	MPLS383412T-50						

\*1 2 pieces required, \*2 PEAD12/SUZ-KA12NAR1



# Optional Parts List for Controllers

			Wall Mount									
			WPH					MSZ-EF				
			06	09	12	15	18	09NAW (B)(S)	12NAW (B)(S)	15NAW (B)(S)	18NAW (B)(S)	
Wireless Signal Receiver	Wireless Signal Receiver	PAR-SA9CA-E										
	Wireless Signal Receiver	PAR-FA32MA-W										
	Wireless Signal Receiver	PAR-FA32MA-E										
	Wireless Remote Receiver Panel	PAR-SF9FA-E										
	Wireless Remote Receiver Panel	PAR-SR3LA-E										
	Remote Controller Holder	U01A01083										
Wireless Remote Controller	Wireless Remote Controller	PAR-SL100A-E										
	Wireless Remote Controller	PAR-FL32MA-E										
	Controller Kit (Sender & Receiver)	PAR-SL93B-E										
	Controller Kit with i-see Sensor™	PAR-SA92MW-E										
	kumo touch™ Backlit, Wall-mounted, Wireless Controller	MHK2	•	•	•	•	•	•	•	•	•	•
Wired Remote Controller	Deluxe MA Remote Controller	TAR-40MAAU	•*1	•*1	•*1	•*1	•*1	•*1	•*1	•*1	•*1	•*1
	Simple MA Controller	TAC-YT53CRAU-J	•*1	•*1	•*1	•*1	•*1	•*1	•*1	•*1	•*1	•*1
	Touch MA Controller	TAR-CT01MAU-SB	•*1	•*1	•*1	•*1	•*1	•*1	•*1	•*1	•*1	•*1
	Airzone ZBS Wired Blueface Principal Controller White	AZZBSBLUEFACECB										
	Airzone ZBS Wired Think Controller White	AZZBSTHINKCB										
	Airzone ZBS Wireless Think Controller White	AZZBSTHINKRB										
	Airzone ZBS Wired Lite Controller White	AZZBSLITECB										
	Airzone ZBS Wireless Lite Controller White	AZZBSLITERB										
Remote Sensor	Wired Remote Sensor	PAC-SE41TS-E										
	Wired Remote Sensor	M21EAA307	•	•	•	•	•	•	•	•	•	•
	Wireless Temperature and Humidity Sensor	PAC-USWHS003-TH-1	•	•	•	•	•	•	•	•	•	•
	Flush Mount Remote Temperature Sensor	PAC-USSEN001-FM-1										
Interface	System Control Interface	MAC-3334F-E	•*3	•*3	•*3	•*3	•*3	•*3	•*3	•*3	•*3	•*3
	Wireless Interface 2	PAC-USWHS002-WF-2	•	•	•	•	•	•	•	•	•	•
	Thermostat Interface	PAC-US444CN-1	•	•	•	•	•	•	•	•	•	•
	kumo station®	PAC-WHS01HC-E	•	•	•	•	•	•	•	•	•	•
	USNAP Interface	PAC-WHS01UP-E	•	•	•	•	•	•	•	•	•	•
	IT Extender	PAC-WHS01IE-E	•	•	•	•	•	•	•	•	•	•
	BACnet® and MODBUS® Interface	PAC-UKPRC001-CN-1	•	•	•	•	•	•	•	•	•	•
	External Fan / Heater Control Relay Adapter	CN24RELAY-KIT-CM3	•	•	•	•	•					
	Wire for Remote on/off with CN32 connector	PAC-715AD										
	Connector and wire for Operation status/error using CN51	PAC-725AD										
	Connector cable for remote display	PAC-SA88HA-EP										
	Connector for CN32 (remote on/off)	PAC-SE55RA-E										
	Lockdown Bracket for Hand-held Remote Controllers	RCMKP1CB	•	•	•	•	•	•	•	•	•	•
	Remote Operation Adapter	PAC-SF40RM-E										

- \*1 (requires MAC-334IF-E).
- \*2 Unable to use with wireless remote controller
- \*3 Allows indoor units to connect to an MA controller





# Optional Parts List for Controllers

			Floor Mount				EZ FIT™			4-way Ceiling Cassette			
			FKS				UKS			CKS			
			09	12	15	18	09	12	18	09	12	15	18
Wireless Signal Receiver	Wireless Signal Receiver	PAR-SA9CA-E											
	Wireless Signal Receiver	PAR-FA32MA-W								•	•	•	•
	Wireless Signal Receiver	PAR-FA32MA-E								•	•	•	•
	Wireless Remote Receiver Panel	PAR-SF9FA-E								•	•	•	•
	Wireless Remote Receiver Panel	PAR-SR3LA-E											
	Remote Controller Holder	U01A01083											
Wireless Remote Controller	Wireless Remote Controller	PAR-SL100A-E								•	•	•	•
	Wireless Remote Controller	PAR-FL32MA-E											
	Controller Kit (Sender & Receiver)	PAR-SL93B-E											
	Controller Kit with i-see Sensor™	PAR-SA92MW-E											
	kumo touch™ Backlit, Wall-mounted, Wireless Controller	MHK2	•	•	•	•	•	•	•	•	•	•	•
Wired Remote Controller	Deluxe MA Remote Controller	TAR-40MAAU	•*1	•*1	•*1	•*1	•*1	•*1	•*1	•	•	•	•
	Simple MA Controller	TAC-YT53CRAU-J	•*1	•*1	•*1	•*1	•*1	•*1	•*1	•	•	•	•
	Touch MA Controller	TAR-CT01MAU-SB	•*1	•*1	•*1	•*1	•*1	•*1	•*1	•	•	•	•
	Airzone ZBS Wired Blueface Principal Controller White	AZZBSBLUEFACECB											
	Airzone ZBS Wired Think Controller White	AZZBSTHINKCB											
	Airzone ZBS Wireless Think Controller White	AZZBSTHINKRB											
	Airzone ZBS Wired Lite Controller White	AZZBSLITECB											
	Airzone ZBS Wireless Lite Controller White	AZZBSLITERB											
Remote Sensor	Wired Remote Sensor	PAC-SE41TS-E								•	•	•	•
	Wired Remote Sensor	M21EAA307	•	•	•	•	•	•	•				
	Wireless Temperature and Humidity Sensor	PAC-USWHS003-TH-1	•	•	•	•	•	•	•	•	•	•	•
	Flush Mount Remote Temperature Sensor	PAC-USSEN001-FM-1								•	•	•	•
Interface	System Control Interface	MAC-3334F-E	•*3	•*3	•*3	•*3	•*3	•*3	•*3	•	•	•	•
	Wireless Interface 2	PAC-USWHS002-WF-2	•	•	•	•	•	•	•	•	•	•	•
	Thermostat Interface	PAC-US444CN-1	•	•	•	•	•	•	•	•	•	•	•
	kumo station®	PAC-WHS01HC-E	•	•	•	•	•	•	•	•	•	•	•
	USNAP Interface	PAC-WHS01UP-E	•	•	•	•	•	•	•	•	•	•	•
	IT Extender	PAC-WHS01IE-E	•	•	•	•	•	•	•	•	•	•	•
	BACnet® and MODBUS® Interface	PAC-UKPRC001-CN-1	•	•	•	•	•	•	•	•	•	•	•
	External Fan / Heater Control Relay Adapter	CN24RELAY-KIT-CM3	•	•	•	•	•	•	•	•	•	•	•
	Wire for Remote on/off with CN32 connector	PAC-715AD								•	•	•	•
	Connector and wire for Operation status/error using CN51	PAC-725AD								•	•	•	•
	Connector cable for remote display	PAC-SA88HA-EP								•	•	•	•
	Connector for CN32 (remote on/off)	PAC-SE55RA-E								•	•	•	•
	Lockdown Bracket for Hand-held Remote Controllers	RCMKP1CB	•	•	•	•	•	•	•				
	Remote Operation Adapter	PAC-SF40RM-E								•*2	•*2	•*2	•*2

- \*1 (requires MAC-334IF-E).
- \*2 Unable to use with wireless remote controller
- \*3 Allows indoor units to connect to an MA controller



# Optional Parts List for Controllers

			4-way Ceiling Cassette					
			PLA-					
			A12EA7	A18EA7	A24EA7	A30EA7	A36EA7	A42EA7
Wireless Signal Receiver	Wireless Signal Receiver	PAR-SA9CA-E						
	Wireless Signal Receiver	PAR-FA32MA-W	•	•	•	•	•	•
	Wireless Signal Receiver	PAR-FA32MA-E	•	•	•	•	•	•
	Wireless Remote Receiver Panel	PAR-SF9FA-E						
	Wireless Remote Receiver Panel	PAR-SR3LA-E	•	•	•	•	•	•
	Remote Controller Holder	U01A01083						
Wireless Remote Controller	Wireless Remote Controller	PAR-SL100A-E						
	Wireless Remote Controller	PAR-FL32MA-E						
	Controller Kit (Sender & Receiver)	PAR-SL93B-E						
	Controller Kit with i-see Sensor™	PAR-SA92MW-E						
	kumo touch™ Backlit, Wall-mounted, Wireless Controller	MHK2	•	•	•	•	•	•
Wired Remote Controller	Deluxe MA Remote Controller	TAR-40MAAU	•	•	•	•	•	•
	Simple MA Controller	TAC-YT53CRAU-J	•	•	•	•	•	•
	Touch MA Controller	TAR-CT01MAU-SB	•	•	•	•	•	•
	Airzone ZBS Wired Blueface Principal Controller White	AZZBSBLUEFACECB						
	Airzone ZBS Wired Think Controller White	AZZBSTHINKCB						
	Airzone ZBS Wireless Think Controller White	AZZBSTHINKRB						
	Airzone ZBS Wired Lite Controller White	AZZBSLITECB						
	Airzone ZBS Wireless Lite Controller White	AZZBSLITERB						
Remote Sensor	Wired Remote Sensor	PAC-SE41TS-E	•	•	•	•	•	•
	Wired Remote Sensor	M21EAA307						
	Wireless Temperature and Humidity Sensor	PAC-USWHS003-TH-1	•	•	•	•	•	•
	Flush Mount Remote Temperature Sensor	PAC-USSEN001-FM-1	•	•	•	•	•	•
Interface	System Control Interface	MAC-3334F-E						
	Wireless Interface 2	PAC-USWHS002-WF-2	•	•	•	•	•	•
	Thermostat Interface	PAC-US444CN-1	•	•	•	•	•	•
	kumo station®	PAC-WHS01HC-E	•	•	•	•	•	•
	USNAP Interface	PAC-WHS01UP-E	•	•	•	•	•	•
	IT Extender	PAC-WHS01IE-E	•	•	•	•	•	•
	BACnet® and MODBUS® Interface	PAC-UKPRC001-CN-1	•	•	•	•	•	•
	External Fan / Heater Control Relay Adapter	CN24RELAY-KIT-CM3	•	•	•	•	•	•
	Wire for Remote on/off with CN32 connector	PAC-715AD						
	Connector and wire for Operation status/error using CN51	PAC-725AD						
	Connector cable for remote display	PAC-SA88HA-EP						
	Connector for CN32 (remote on/off)	PAC-SE55RA-E	•	•	•	•	•	•
	Lockdown Bracket for Hand-held Remote Controllers	RCMKP1CB	•	•	•	•	•	•
Remote Operation Adapter	PAC-SF40RM-E	•*2	•*2	•*2	•*2	•*2	•*2	

- \*1 (requires MAC-334IF-E).
- \*2 Unable to use with wireless remote controller
- \*3 Allows indoor units to connect to an MA controller



# Additional Nv-Series Information

## Port Adapters Parts Numbers

Model Name	Diameter A	Diameter B
MAC-A454JP-E	3/8"	1/2"
MAC-A455JP-E	1/2"	3/8"
MAC-A456JP-E	1/2"	5/8"
PAC-SG76RJ-E	3/8"	5/8"
ADP5834	5/8"	3/4"
PAC-493PI	1/4"	3/8"

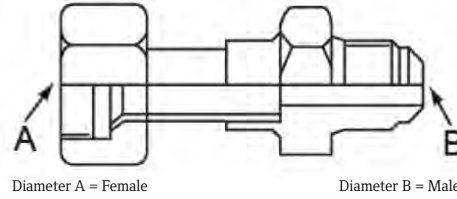

## Multi-zone Efficiency Ratings

Model	Configuration	SEER	EER	HSPF
NTXMMX20A122A*	Ducted	16.00	10.00	9.30
	Mixed	18.00	11.35	9.65
	Non-Ducted	20.00	12.70	10.00
NTXMMX24A132A*	Ducted	16.00	11.20	9.20
	Mixed	18.00	12.40	9.50
	Non-Ducted	20.00	13.60	9.80
NTXMMX30A132A*	Ducted	16.20	9.60	9.60
	Mixed	17.60	10.10	10.10
	Non-Ducted	19.00	10.60	10.60
NTXMMX36A142A*	Ducted	16.00	8.70	9.80
	Mixed	17.60	9.05	10.40
	Non-Ducted	19.20	9.40	11.00
NTXMMX42A152A*	Ducted	15.20	9.00	9.10
	Mixed	17.45	9.10	9.70
	Non-Ducted	19.70	9.20	10.30
NTXMMX48A182A*	Ducted	18.90	12.00	11.40
	Mixed	16.80	10.75	10.75
	Non-Ducted	14.70	9.50	10.10
NTXMMX60A182A*	Ducted	15.10	9.60	10.00
	Mixed	16.25	11.05	10.25
	Non-Ducted	17.40	12.50	10.50
NTXMPH20A122A*	Ducted	15.00	11.00	9.50
	Mixed	16.00	12.25	9.65
	Non-Ducted	17.00	13.50	9.80
NTXMPH24A132A*	Ducted	15.50	10.00	9.00
	Mixed	17.25	11.75	9.50
	Non-Ducted	19.00	13.50	10.00
NTXMPH30A132A*	Ducted	16.00	10.30	9.80
	Mixed	17.00	11.40	10.40
	Non-Ducted	18.00	12.50	11.00
NTXMPH36A142A*	Ducted	15.80	11.30	10.10
	Mixed	17.45	12.65	10.70
	Non-Ducted	19.10	14.00	11.30
NTXMPH42A152A*	Ducted	15.00	10.80	10.10
	Mixed	17.00	12.10	10.55
	Non-Ducted	19.00	13.40	11.00
NTXMMX48A182A*	Ducted	14.70	9.50	10.00
	Mixed	16.80	10.75	10.50
	Non-Ducted	18.90	12.00	11.00



Nv-Series Air Outlet Coverage Range\*

Model	Mode	Function	Airflow (CFM)	Coverage (FT)
NTXWPH06A112A*, NTXWPH09A112A*	HEAT	DRY	437	29.8
	COOL	WET	328	22.5
NTXWPH12A112A*	HEAT	DRY	454	31.0
	COOL	WET	342	23.5
NTXWPH15A112A*	HEAT	DRY	497	33.8
	COOL	WET	354	24.1
NTXWPH18A112A*	HEAT	DRY	514	34.9
	COOL	WET	395	27.0
NTXWST06/09/12A112A*, NTYWST06/09/12A112A*	HEAT	DRY	406	29.5
	COOL	WET	286	21.0
NTXWST15A112A*, NTYWST15A112A*	HEAT	DRY	463	33.5
	COOL	WET	385	28.0
NTXWST18A112A*, NTYWST18A112A*	HEAT	DRY	646	44.0
	COOL	WET	581	39.7
NTXWST24A112A*, NTYWST24A112A*	HEAT	DRY	738	36.9
	COOL	WET	661	33.2
NTXWST30/36A112A*, NTYWST30/36A112A*	HEAT	DRY	848	45.0
	COOL	WET	763	40.7
NTXFKS09A112A*, NTXFKS12A112A*	HEAT	DRY	417	29.6
	COOL	WET	354	25.3
NTXFKS15A112A*	HEAT	DRY	470	33.3
	COOL	WET	366	26.2
NTXFKS18A112A*	HEAT	DRY	470	33.3
	COOL	WET	417	29.7
NTXCKS09A112A*	HEAT	DRY	300	15.1
	COOL	WET	270	13.7
NTXCKS12A112A*	HEAT	DRY	336	16.9
	COOL	WET	302	15.2
NTXCKS15A112A*	HEAT	DRY	405	20.3
	COOL	WET	365	18.3
NTXCKS18A112A*	HEAT	DRY	475	23.7
	COOL	WET	429	21.4
MSZ-EF09NAW(B)(S)	HEAT	DRY	420	29.2
	COOL	WET	319	22.3
MSZ-EF12NAW(B)(S)	HEAT	DRY	448	31.1
	COOL	WET	319	22.3
MSZ-EF15NAW(B)(S)	HEAT	DRY	448	31.1
	COOL	WET	313	21.9
MSZ-EF18NAW(B)(S)	HEAT	DRY	466	32.3
	COOL	WET	334	23.4
NTXWMT09A112A*, NTXWMT12A112A*	HEAT	DRY	406	29.5
	COOL	WET	286	21.0
NTXWMT15A112A*	HEAT	DRY	463	33.5
	COOL	WET	385	28.0
NTXWMT18A112A*	HEAT	DRY	625	42.6
	COOL	WET	562	38.4
NTXWMT24A112A*	HEAT	DRY	702	47.7
	COOL	WET	632	43.1
NTXWMT09A111A*	HEAT	DRY	406	29.5
	COOL	WET	364	26.5
NTXWMT12A111A*	HEAT	DRY	406	29.5
	COOL	WET	364	26.5
NTXWEL09A112A*	HEAT	DRY	406	29.5
	COOL	WET	286	21.0
NTXWEL12A112A*	HEAT	DRY	406	29.5
	COOL	WET	286	21.0
NTXWEL18A112A*	HEAT	DRY	625	42.6
	COOL	WET	562	38.4
NTXWEL24A112A*	HEAT	DRY	702	47.7
	COOL	WET	632	43.1
NTXUKS09A112A*	HEAT	DRY	311	20.7
	COOL	WET	325	21.7
NTXUKS12A112A*	HEAT	DRY	332	22.1
	COOL	WET	350	23.3
NTXUKS18A112A*	HEAT	DRY	403	26.7
	COOL	WET	417	27.6

# Heating Capacity

Outdoor Temperature Degrees (° F)		50	41.0	32.0	23.0	14.0	5.0	-4	-13
NTXWPH06A112A*/NTXSPH06A112A*	Heating Capacity (Btu/h)	8,700	8,700	8,700	8,700	8,700	8,700	7,650	6,430
	Percentage of Rated Capacity	100%	100%	100%	100%	100%	100%	88%	74%
NTXWPH09A112A*/NTXSPH09A112A*	Heating Capacity (Btu/h)	10,900	10,900	10,900	10,900	10,900	10,900	9,260	7,630
	Percentage of Rated Capacity	100%	100%	100%	100%	100%	100%	85%	70%
NTXWPH12NA/NTXSPH12A112A*	Heating Capacity (Btu/h)	13,600	13,600	13,600	13,600	13,600	13,600	11,690	9,920
	Percentage of Rated Capacity	100%	100%	100%	100%	100%	100%	86%	73%
NTXWPH15A112A*/NTXSPH15A112A*	Heating Capacity (Btu/h)	18,000	18,000	18,000	18,000	18,000	18,000	16,200	14,580
	Percentage of Rated Capacity	100%	100%	100%	100%	100%	100%	90%	81%
NTXWPH18A112A*/MUZ-FH18NA2	Heating Capacity (Btu/h)	20,300	20,300	20,300	20,300	20,300	20,300	17,250	14,210
	Percentage of Rated Capacity	100%	100%	100%	100%	100%	100%	85%	70%
NTXWPH06A112A*/NTXSPB06A112A*	Heating Capacity (Btu/h)	8,700	8,700	8,700	8,700	8,700	8,700	7,650	6,430
	Percentage of Rated Capacity	100%	100%	100%	100%	100%	100%	88%	74%
NTXWPH09A112A*/NTXSPB09A112A*	Heating Capacity (Btu/h)	10,900	10,900	10,900	10,900	10,900	10,900	9,370	7,950
	Percentage of Rated Capacity	100%	100%	100%	100%	100%	100%	86%	73%
NTXWPH12NA/NTXSPB12A112A*	Heating Capacity (Btu/h)	13,600	13,600	13,600	13,600	13,600	13,600	11,690	9,920
	Percentage of Rated Capacity	100%	100%	100%	100%	100%	100%	86%	73%
NTXWPH15A112A*/NTXSPB15A112A*	Heating Capacity (Btu/h)	18,000	18,000	18,000	18,000	18,000	18,000	16,200	14,580
	Percentage of Rated Capacity	100%	100%	100%	100%	100%	100%	90%	81%
NTXWPH18A112A*/MUZ-FH18NA2H	Heating Capacity (Btu/h)	20,300	20,300	20,300	20,300	20,300	20,300	17,250	14,210
	Percentage of Rated Capacity	100%	100%	100%	100%	100%	100%	85%	70%
NTXWST09A112A*/NTXSST09A112A*	Heating Capacity (Btu/h)	10,900	10,900	10,900	10,460	9,480	8,170	6,860	-
	Percentage of Rated Capacity	100%	100%	100%	96%	87%	75%	63%	0%
NTXWST12A112A*/NTXSST12A112A*	Heating Capacity (Btu/h)	14,400	14,400	14,110	12,960	11,660	9,790	7,920	-
	Percentage of Rated Capacity	100%	100%	98%	90%	81%	68%	55%	0%
NTXWST15A112A*/NTXSST15A112A*	Heating Capacity (Btu/h)	18,000	17,100	16,920	16,920	16,200	13,680	11,160	-
	Percentage of Rated Capacity	100%	95%	94%	94%	90%	76%	62%	0%
NTXWST18A112A*/NTXSST18A112A*	Heating Capacity (Btu/h)	21,600	21,600	21,600	19,440	17,060	14,900	12,520	-
	Percentage of Rated Capacity	100%	100%	100%	90%	79%	69%	58%	0%
NTXWST24A112A*/NTXSST24A112A*	Heating Capacity (Btu/h)	27,600	27,600	27,600	26,220	23,460	19,320	15,450	-
	Percentage of Rated Capacity	100%	100%	100%	95%	85%	70%	56%	0%
NTXWMT09A112A*/NTXSMT09A112A*	Heating Capacity (Btu/h)	10,900	10,570	9,480	8,500	7,300	5,990	4,680	-
	Percentage of Rated Capacity	100%	97%	87%	78%	67%	55%	43%	0%
NTXWMT12A112A*/NTXSMT12A112A*	Heating Capacity (Btu/h)	12,200	12,200	11,220	10,120	9,020	7,440	5,850	-
	Percentage of Rated Capacity	100%	100%	92%	83%	74%	61%	48%	0%
NTXWMT15A112A*/NTXSMT15A112A*	Heating Capacity (Btu/h)	18,000	15,300	14,940	14,400	13,680	12,240	10,620	-
	Percentage of Rated Capacity	100%	85%	83%	80%	76%	68%	59%	0%
NTXWMT18A112A*/NTXSMT18A112A*	Heating Capacity (Btu/h)	18,000	18,000	18,000	16,560	14,580	12,780	10,980	-
	Percentage of Rated Capacity	100%	100%	100%	92%	81%	71%	61%	0%
NTXWMT24A112A*/NTXSMT24A112A*	Heating Capacity (Btu/h)	26,000	24,440	22,360	20,020	17,680	15,600	13,260	-
	Percentage of Rated Capacity	100%	94%	86%	77%	68%	60%	51%	0%
NTXWST30A112A*/NTXSST30A112A*	Heating Capacity (Btu/h)	32,600	28,030	25,420	22,820	19,880	-	-	-
	Percentage of Rated Capacity	100%	86%	78%	70%	61%	0%	0%	0%
NTXWST36A112A*/NTXSST36A112A*	Heating Capacity (Btu/h)	35,200	29,560	27,450	25,340	22,880	-	-	-
	Percentage of Rated Capacity	100%	84%	78%	72%	65%	0%	0%	0%
NTXWMT09A111A*/NTXSMT09A111A*	Heating Capacity (Btu/h)	10,900	10,570	9,480	8,500	7,300	5,990	4,680	-
	Percentage of Rated Capacity	100%	97%	87%	78%	67%	55%	43%	0%
NTXWMT12A111A*/NTXSMT12A111A*	Heating Capacity (Btu/h)	12,200	12,200	11,220	10,120	9,020	7,440	5,850	-
	Percentage of Rated Capacity	100%	100%	92%	83%	74%	61%	48%	0%
NTXWEL09A112A*/NTXSEL09A112A*	Heating Capacity (Btu/h)	10,900	10,570	9,480	8,500	7,300	5,990	-	-
	Percentage of Rated Capacity	100%	97%	87%	78%	67%	55%	0%	0%
NTXWEL12A112A*/NTXSEL12A112A*	Heating Capacity (Btu/h)	12,200	12,200	11,220	10,120	9,020	7,440	-	-
	Percentage of Rated Capacity	100%	100%	92%	83%	74%	61%	0%	0%
NTXWEL18A112A*/NTXSEL18A112A*	Heating Capacity (Btu/h)	18,000	18,000	18,000	16,560	14,580	12,780	-	-
	Percentage of Rated Capacity	100%	100%	100%	92%	81%	71%	0%	0%
NTXWEL24A112A*/NTXSEL24A112A*	Heating Capacity (Btu/h)	26,000	24,440	22,360	20,020	17,680	15,600	-	-
	Percentage of Rated Capacity	100%	94%	86%	77%	68%	60%	0%	0%
NTXFKS09A112A*/NTXSPF09A112A*	Heating Capacity (Btu/h)	11,000	11,000	11,000	11,000	11,000	11,000	9,130	7,260
	Percentage of Rated Capacity	100%	100%	100%	100%	100%	100%	83%	66%

# Heating Capacity

Outdoor Temperature Degrees (° F)		50	41.0	32.0	23.0	14.0	5.0	-4	-13
NTXFKS12A112A*/NTXSPF12A112A*	Heating Capacity (Btu/h)	13,000	13,000	13,000	13,000	13,000	13,000	10,790	8,450
	Percentage of Rated Capacity	100%	100%	100%	100%	100%	100%	83%	65%
NTXFKS15A112A*/NTXSPF15A112A*	Heating Capacity (Btu/h)	18,000	18,000	18,000	18,000	18,000	18,000	14,940	13,860
	Percentage of Rated Capacity	100%	100%	100%	100%	100%	100%	83%	77%
NTXFKS18A112A*/NTXSPF18A112A*	Heating Capacity (Btu/h)	21,000	21,000	21,000	21,000	21,000	21,000	18,480	15,960
	Percentage of Rated Capacity	100%	100%	100%	100%	100%	100%	88%	76%
NTXUKS09A112A*/NTXSKS09A112A*	Heating Capacity (Btu/h)	12,000	10,620	9,230	7,840	6,450	5,090	3,770	-
	Percentage of Rated Capacity	100%	89%	77%	65%	54%	42%	31%	0%
NTXUKS12A112A*/NTXSKS12A112A*	Heating Capacity (Btu/h)	15,400	13,630	11,850	10,060	8,280	6,540	4,840	-
	Percentage of Rated Capacity	100%	89%	77%	65%	54%	42%	31%	0%
NTXUKS18A112A*/NTXSKS18A112A*	Heating Capacity (Btu/h)	20,000	17,700	15,390	13,060	10,760	8,490	6,290	-
	Percentage of Rated Capacity	100%	89%	77%	65%	54%	42%	31%	0%
NTXCKS09A112A*/NTXSKS09A112A*	Heating Capacity (Btu/h)	11,000	9,730	8,460	7,180	5,920	4,670	3,460	-
	Percentage of Rated Capacity	100%	89%	77%	65%	54%	42%	31%	0%
NTXCKS12A112A*/NTXSKS12A112A*	Heating Capacity (Btu/h)	13,000	11,510	10,000	8,490	6,990	5,520	4,080	-
	Percentage of Rated Capacity	100%	89%	77%	65%	54%	42%	31%	0%
NTXCKS15A112A*/NTXSKS15A112A*	Heating Capacity (Btu/h)	18,000	15,930	13,850	11,760	9,680	7,640	5,660	-
	Percentage of Rated Capacity	100%	89%	77%	65%	54%	42%	31%	0%
NTXCKS18A112A*/NTXSKS18A112A*	Heating Capacity (Btu/h)	19,700	17,440	15,150	12,870	10,600	8,370	6,190	-
	Percentage of Rated Capacity	100%	89%	77%	65%	54%	42%	31%	0%
NTXDKS09A112A*/NTXSKS09A112A*	Heating Capacity (Btu/h)	12,000	10,620	9,230	7,840	6,450	5,090	3,770	-
	Percentage of Rated Capacity	100%	89%	77%	65%	54%	42%	31%	0%
NTXDKS12A112A*/NTXSKS12A112A*	Heating Capacity (Btu/h)	15,000	13,280	11,540	9,800	8,070	6,370	4,710	-
	Percentage of Rated Capacity	100%	89%	77%	65%	54%	42%	31%	0%
NTXDKS15A112A*/NTXSKS15A112A*	Heating Capacity (Btu/h)	18,000	15,930	13,850	11,760	9,680	7,640	5,660	-
	Percentage of Rated Capacity	100%	89%	77%	65%	54%	42%	31%	0%
NTXDKS18A112A*/NTXSKS18A112A*	Heating Capacity (Btu/h)	21,600	19,120	16,620	14,110	11,620	9,170	6,790	-
	Percentage of Rated Capacity	100%	89%	77%	65%	54%	42%	31%	0%
PEAD-A09AA7/NTXSKS09A112A*	Heating Capacity (Btu/h)	12,000	10,620	9,230	7,840	6,450	5,090	3,770	-
	Percentage of Rated Capacity	100%	89%	77%	65%	54%	42%	31%	0%
PEAD-A12AA7/NTXSKS12A112A*	Heating Capacity (Btu/h)	15,000	13,280	11,540	9,800	8,070	6,370	4,710	-
	Percentage of Rated Capacity	100%	89%	77%	65%	54%	42%	31%	0%
PEAD-A15AA7/NTXSKS15A112A*	Heating Capacity (Btu/h)	18,000	15,930	13,850	11,760	9,680	7,640	5,660	-
	Percentage of Rated Capacity	100%	89%	77%	65%	54%	42%	31%	0%
PEAD-A18AA7/NTXSKS18A112A*	Heating Capacity (Btu/h)	21,600	19,120	16,620	14,110	11,620	9,170	6,790	-
	Percentage of Rated Capacity	100%	89%	77%	65%	54%	42%	31%	0%
PEAD-A24AA7/NTXSKS24A112A*	Heating Capacity (Btu/h)	25,000	22,130	19,230	16,330	13,450	-	-	-
	Percentage of Rated Capacity	100%	89%	77%	65%	54%	0%	0%	0%
PEAD-A30AA7/NTXSKS30A112A*	Heating Capacity (Btu/h)	30,000	26,560	23,080	19,600	16,140	-	-	-
	Percentage of Rated Capacity	100%	89%	77%	65%	54%	0%	0%	0%
PEAD-A36AA7/NTXSKS36A112A*	Heating Capacity (Btu/h)	33,500	29,660	25,770	21,890	18,030	-	-	-
	Percentage of Rated Capacity	100%	89%	77%	65%	54%	0%	0%	0%
NTXAMT12A112A*/NTXSKS12A112A*	Heating Capacity (Btu/h)	15,000	13,280	11,540	9,800	8,070	6,370	4,710	-
	Percentage of Rated Capacity	100%	89%	77%	65%	54%	42%	31%	0%
NTXAMT18A112A*/NTXSKS18A112A*	Heating Capacity (Btu/h)	21,600	19,120	16,620	14,110	11,620	9,170	6,790	-
	Percentage of Rated Capacity	100%	89%	77%	65%	54%	42%	31%	0%
NTXAMT24A112A*/NTXSKS24A112A*	Heating Capacity (Btu/h)	25,000	22,130	19,230	16,330	13,450	-	-	-
	Percentage of Rated Capacity	100%	89%	77%	65%	54%	0%	0%	0%
NTXAMT30A112A*/NTXSKS30A112A*	Heating Capacity (Btu/h)	30,000	26,560	23,080	19,600	16,140	-	-	-
	Percentage of Rated Capacity	100%	89%	77%	65%	54%	0%	0%	0%
NTXAMT36A112A*/NTXSKS36A112A*	Heating Capacity (Btu/h)	33,500	29,660	25,770	21,890	18,030	-	-	-
	Percentage of Rated Capacity	100%	89%	77%	65%	54%	0%	0%	0%
NTXMMX20A122A*	Heating Capacity (Btu/h)	22,000	22,000	18,920	15,840	12,980	9,900	-	-
	Percentage of Rated Capacity	100%	100%	86%	72%	59%	45%	0%	0%
NTXMMX24A132A*	Heating Capacity (Btu/h)	25,000	25,000	24,000	20,750	17,250	13,250	-	-
	Percentage of Rated Capacity	100%	100%	96%	83%	69%	53%	0%	0%
NTXMMX30A132A*	Heating Capacity (Btu/h)	28,600	28,600	28,020	24,310	20,300	15,730	-	-
	Percentage of Rated Capacity	100%	100%	98%	85%	71%	55%	0%	0%

# Heating Capacity

Outdoor Temperature Degrees (° F)		50	41.0	32.0	23.0	14.0	5.0	-4	-13
NTXMMX36A142A*	Heating Capacity (Btu/h)	36,000	36,000	33,480	29,160	24,120	18,720	-	-
	Percentage of Rated Capacity	100%	100%	93%	81%	67%	52%	0%	0%
NTXMMX42A152A*	Heating Capacity (Btu/h)	45,000	45,000	41,850	36,450	30,150	23,400	-	-
	Percentage of Rated Capacity	100%	100%	93%	81%	67%	52%	0%	0%
NTXMMX48A182A*	Heating Capacity (Btu/h)	54,000	54,000	52,920	44,820	36,180	32,400	28,620	-
	Percentage of Rated Capacity	100%	100%	98%	83%	67%	60%	53%	0%
NTXMMX60A182A*	Heating Capacity (Btu/h)	66,000	66,000	66,000	56,100	44,880	39,600	34,320	29,040
	Percentage of Rated Capacity	100%	100%	100%	85%	68%	60%	52%	44%
NTXMPH20A122A*	Heating Capacity (Btu/h)	22,000	22,000	22,000	22,000	22,000	22,000	21,120	20,460
	Percentage of Rated Capacity	100%	100%	100%	100%	100%	100%	96%	93%
NTXMPH24A132A*	Heating Capacity (Btu/h)	25,000	25,000	25,000	25,000	25,000	25,000	23,750	22,500
	Percentage of Rated Capacity	100%	100%	100%	100%	100%	100%	95%	90%
NTXMPH30A132A*	Heating Capacity (Btu/h)	28,600	28,600	28,600	28,600	28,600	28,600	26,880	25,160
	Percentage of Rated Capacity	100%	100%	100%	100%	100%	100%	94%	88%
NTXMPH36A142A*	Heating Capacity (Btu/h)	45,000	45,000	45,000	45,000	45,000	45,000	39,600	33,750
	Percentage of Rated Capacity	100%	100%	100%	100%	100%	100%	88%	75%
NTXMPH42A152A*	Heating Capacity (Btu/h)	48,000	48,000	48,000	48,000	48,000	48,000	42,240	36,000
	Percentage of Rated Capacity	100%	100%	100%	100%	100%	100%	88%	75%
NTXMPH48A182A*	Heating Capacity (Btu/h)	54,000	54,000	54,000	54,000	54,000	54,000	47,520	40,500
	Percentage of Rated Capacity	100%	100%	100%	100%	100%	100%	88%	75%
NTXUKS09A112A*/NTXSKH09A112A*	Heating Capacity (Btu/h)	12,000	12,000	12,000	12,000	12,000	12,000	10,320	9,120
	Percentage of Rated Capacity	100%	100%	100%	100%	100%	100%	86%	76%
NTXUKS12A112A*/NTXSKH12A112A*	Heating Capacity (Btu/h)	15,000	15,000	15,000	15,000	15,000	15,000	12,900	11,400
	Percentage of Rated Capacity	100%	100%	100%	100%	100%	100%	86%	76%
NTXUKS18A112A*/NTXSKH18A112A*	Heating Capacity (Btu/h)	18,600	18,600	18,600	18,600	18,600	18,600	15,996	14,136
	Percentage of Rated Capacity	100%	100%	100%	100%	100%	100%	86%	76%
NTXCKS09A112A*/NTXSKH09A112A*	Heating Capacity (Btu/h)	11,000	11,000	11,000	11,000	11,000	11,000	9,460	8,360
	Percentage of Rated Capacity	100%	100%	100%	100%	100%	100%	86%	76%
NTXCKS12A112A*/NTXSKH12A112A*	Heating Capacity (Btu/h)	13,800	13,800	13,800	13,800	13,800	13,800	11,868	10,488
	Percentage of Rated Capacity	100%	100%	100%	100%	100%	100%	86%	76%
NTXCKS15A112A*/NTXSKH15A112A*	Heating Capacity (Btu/h)	16,400	16,400	16,400	16,400	16,400	16,400	14,104	12,464
	Percentage of Rated Capacity	100%	100%	100%	100%	100%	100%	86%	76%
NTXCKS18A112A*/NTXSKH18A112A*	Heating Capacity (Btu/h)	18,800	18,800	18,800	18,800	18,800	18,800	16,168	14,288
	Percentage of Rated Capacity	100%	100%	100%	100%	100%	100%	86%	76%
NTXDKS09A112A*/NTXSKH09A112A*	Heating Capacity (Btu/h)	12,500	12,500	12,500	12,500	12,500	12,500	10,750	9,500
	Percentage of Rated Capacity	100%	100%	100%	100%	100%	100%	86%	76%
NTXDKS12A112A*/NTXSKH12A112A*	Heating Capacity (Btu/h)	15,000	15,000	15,000	15,000	15,000	15,000	12,900	11,400
	Percentage of Rated Capacity	100%	100%	100%	100%	100%	100%	86%	76%
NTXDKS15A112A*/NTXSKH15A112A*	Heating Capacity (Btu/h)	18,000	18,000	18,000	18,000	18,000	18,000	15,480	13,680
	Percentage of Rated Capacity	100%	100%	100%	100%	100%	100%	86%	76%
NTXDKS18A112A*/NTXSKH18A112A*	Heating Capacity (Btu/h)	21,600	21,600	21,600	21,600	21,600	21,600	18,576	16,416
	Percentage of Rated Capacity	100%	100%	100%	100%	100%	100%	86%	76%
PEAD-A09AA7/NTXSKH09A112A*	Heating Capacity (Btu/h)	12,000	12,000	12,000	12,000	12,000	12,000	10,320	9,120
	Percentage of Rated Capacity	100%	100%	100%	100%	100%	100%	86%	76%
PEAD-A12AA7/NTXSKH12A112A*	Heating Capacity (Btu/h)	15,000	15,000	15,000	15,000	15,000	15,000	12,900	11,400
	Percentage of Rated Capacity	100%	100%	100%	100%	100%	100%	86%	76%
PEAD-A15AA7/NTXSKH15A112A*	Heating Capacity (Btu/h)	18,000	18,000	18,000	18,000	18,000	18,000	15,480	13,680
	Percentage of Rated Capacity	100%	100%	100%	100%	100%	100%	86%	76%
PEAD-A18AA7/NTXSKH18A112A*	Heating Capacity (Btu/h)	21,600	21,600	21,600	21,600	21,600	21,600	18,576	16,416
	Percentage of Rated Capacity	100%	100%	100%	100%	100%	100%	86%	76%
NTXAMT12A112A*/NTXSKH12A112A*	Heating Capacity (Btu/h)	15,000	15,000	15,000	15,000	15,000	15,000	12,900	11,400
	Percentage of Rated Capacity	100%	100%	100%	100%	100%	100%	86%	76%
NTXAMT18A112A*/NTXSKH18A112A*	Heating Capacity (Btu/h)	21,600	21,600	21,600	21,600	21,600	21,600	18,576	16,416
	Percentage of Rated Capacity	100%	100%	100%	100%	100%	100%	86%	76%



# Additional P-Series Information

Outlet Air Speed and Coverage Range\*

Model	AIRFLOW (CFM)	AIR SPEED (FT/SEC)	COVERAGE RANGE (FT)
PLA-A12EA7	530	7.8	13
PLA-A18EA7	600	8.8	14
PLA-A24EA7	810	11.9	19
PLA-A30EA7	880	12.9	21
PLA-A36EA7	1200	17.6	28
PLA-A42EA7	1200	17.6	28
PKA-A12HA7	425	20.0	35
PKA-A18HA7	425	20.0	35
PKA-A24KA7	775	19.7	47
PKA-A30KA7	775	19.7	47
PKA-A36KA7	920	22.3	53
PCA-A24KA7	670	10.2	32
PCA-A30KA7	705	10.5	33
PCA-A36KA7	990	11.8	41
PCA-A42KA7	1,025	12.1	42

\*Air coverage represents the distance with 0.8 ft/sec air speed when blowing out horizontally from the unit operating at the high fan speed. This is a general guideline; actual coverage depends on size and layout of the room.



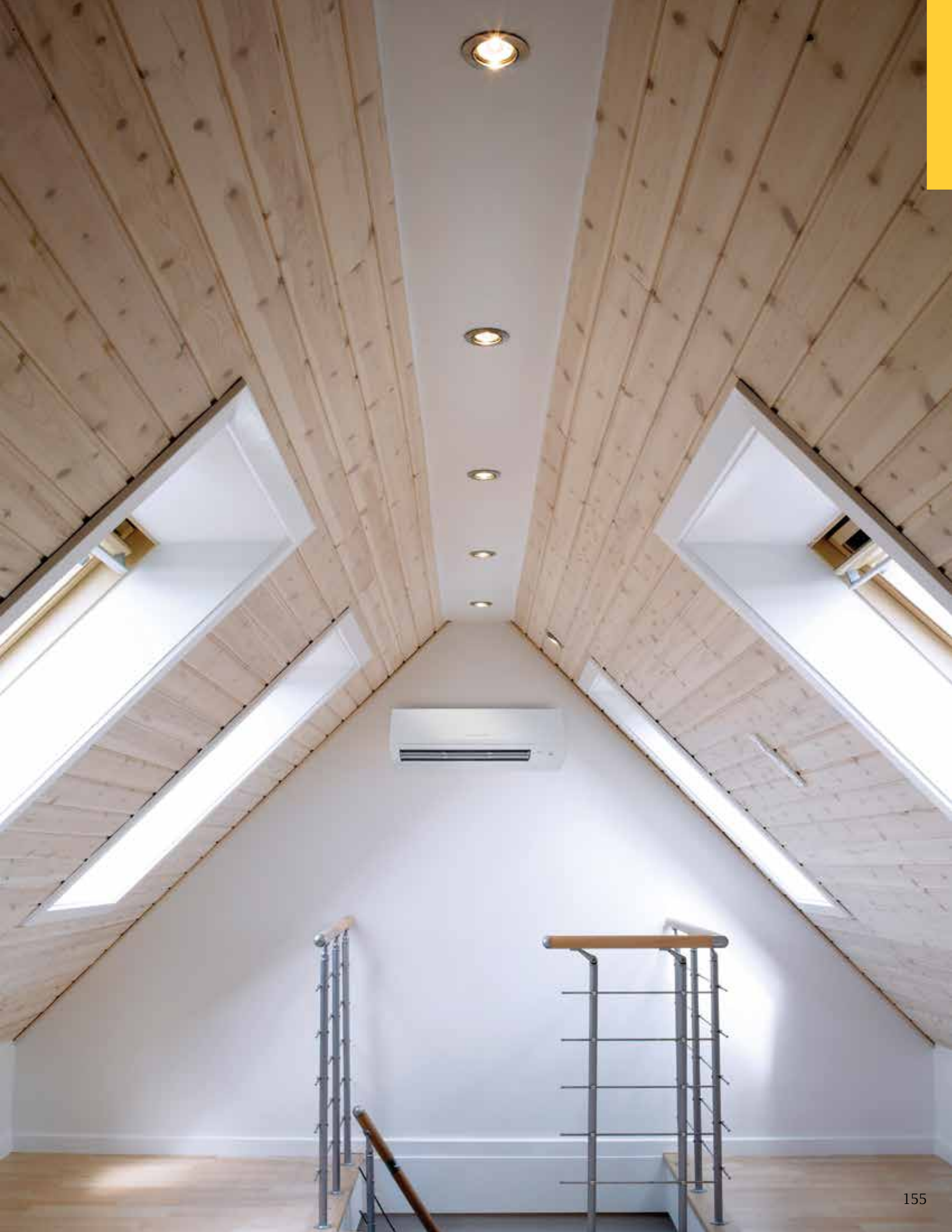



# Correction Factors:

## Cooling Correction Factors: PUY

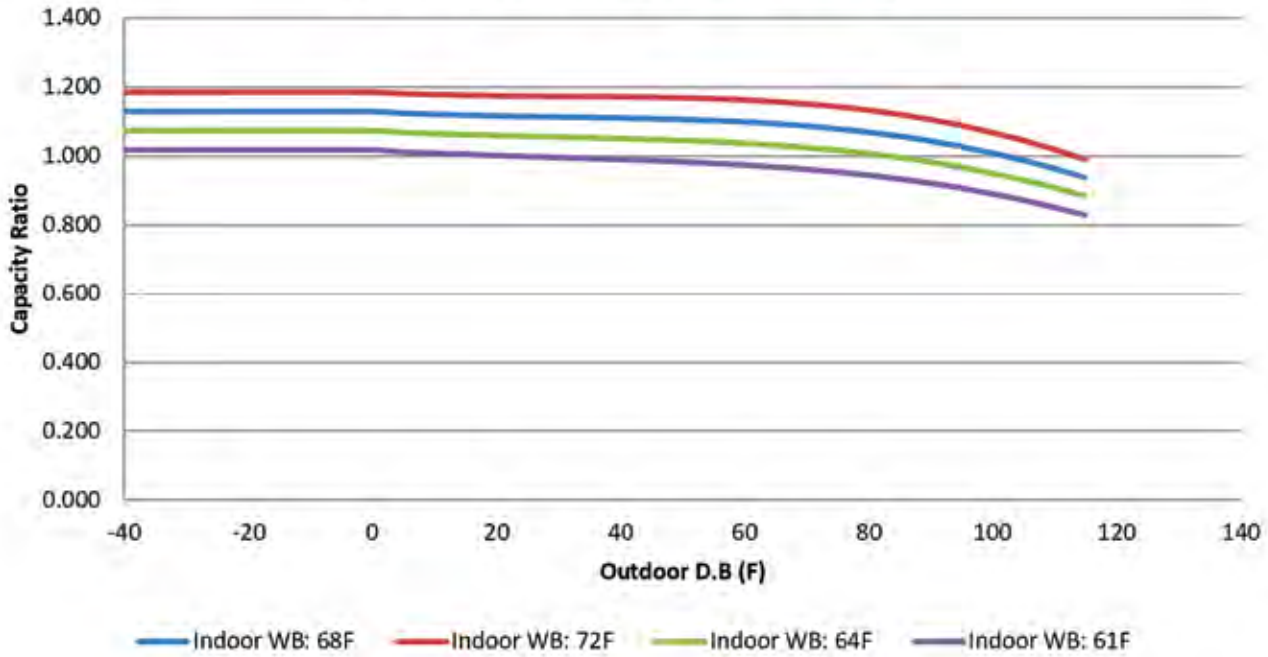

## Cooling Piping Correction Factors: PUY

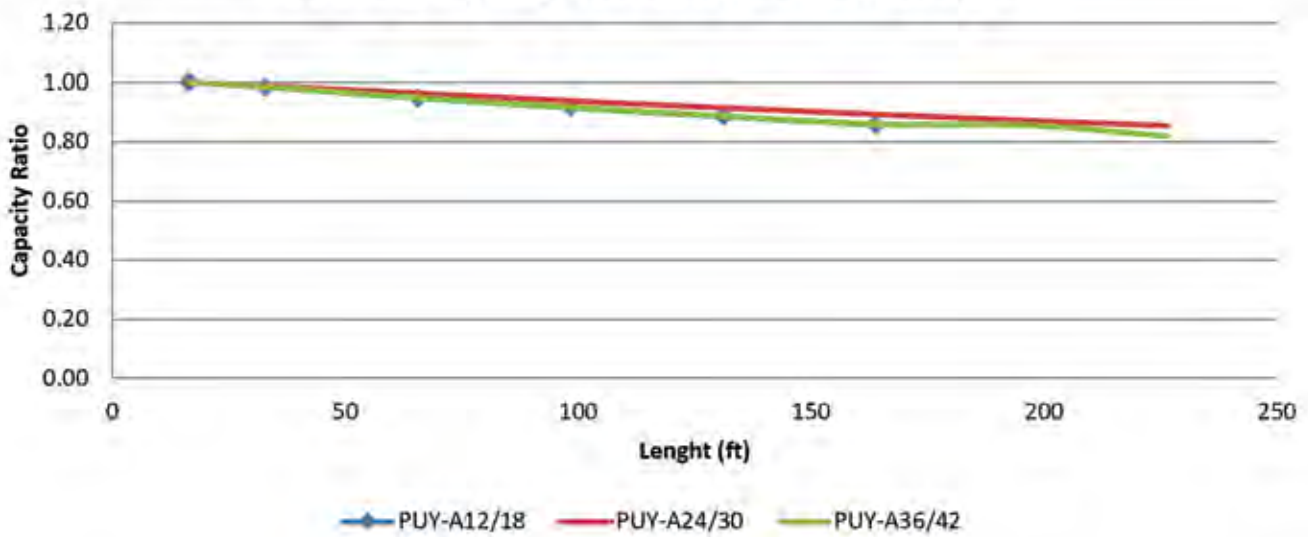

### Cooling Correction Factors: PUZ

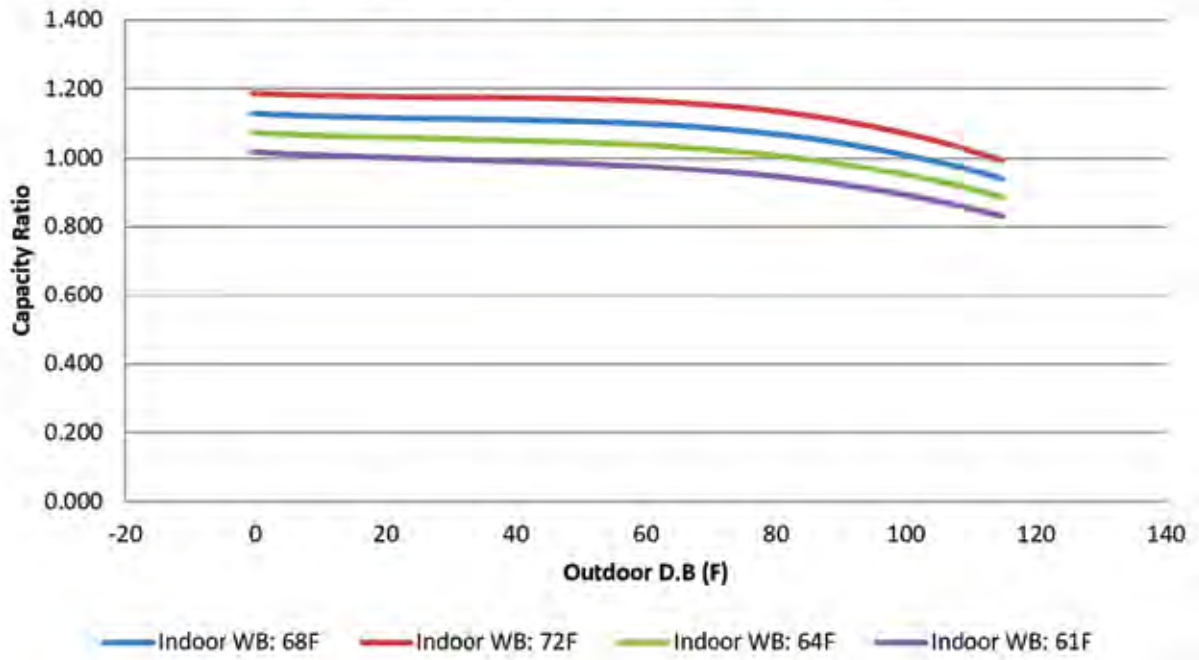

### Heating Correction Factors: PUZ

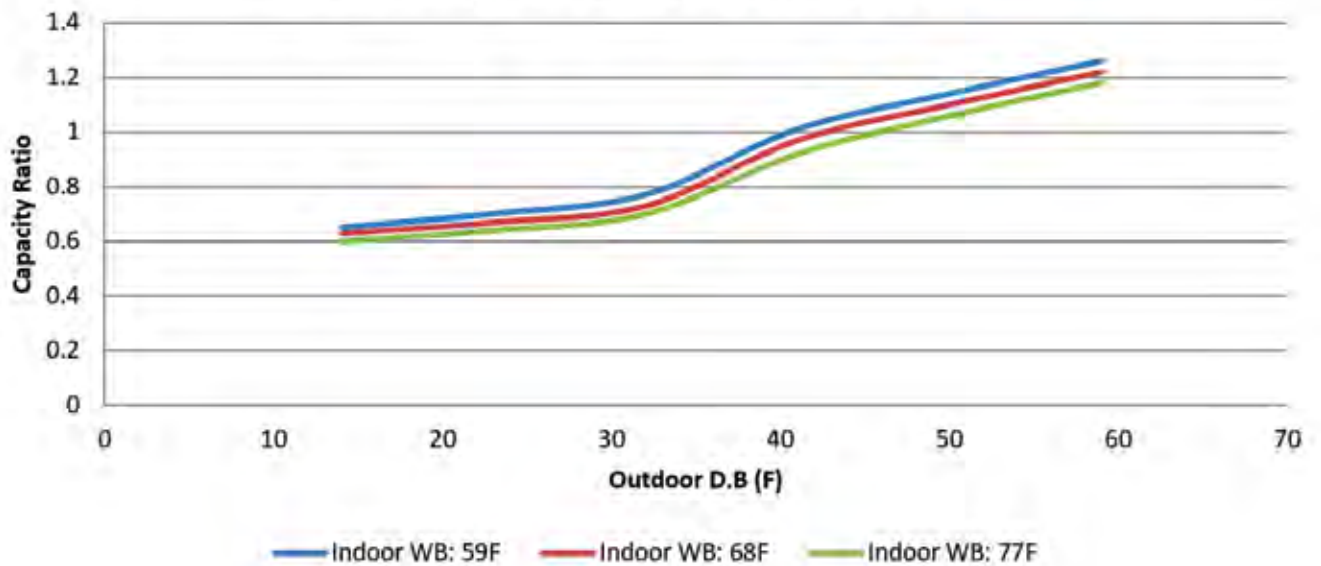

## Correction Factors:

### Cooling Piping Correction Factors: PUZ

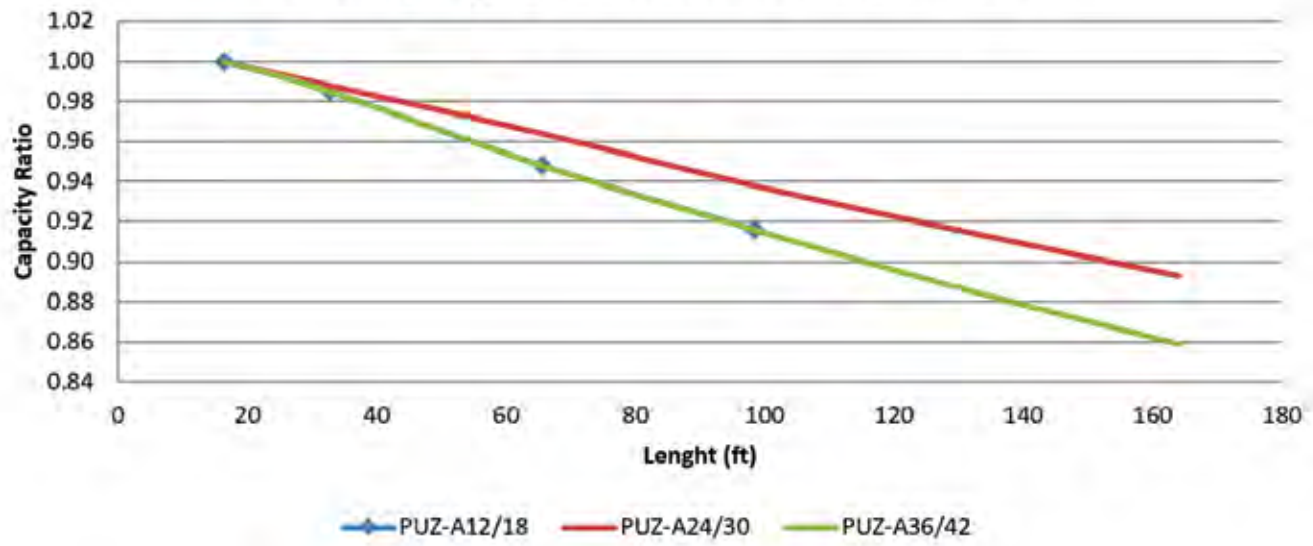

### Cooling Correction Factors: PUZ-HA

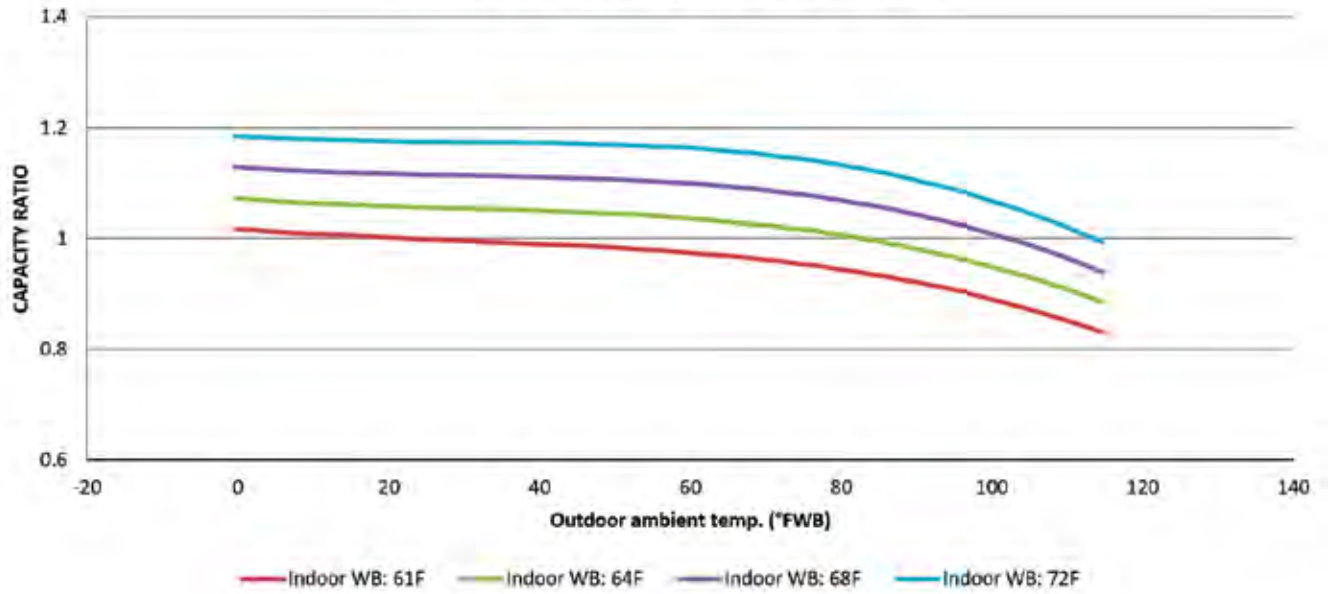

### Heating Corrcetion Factors: PUZ-HA

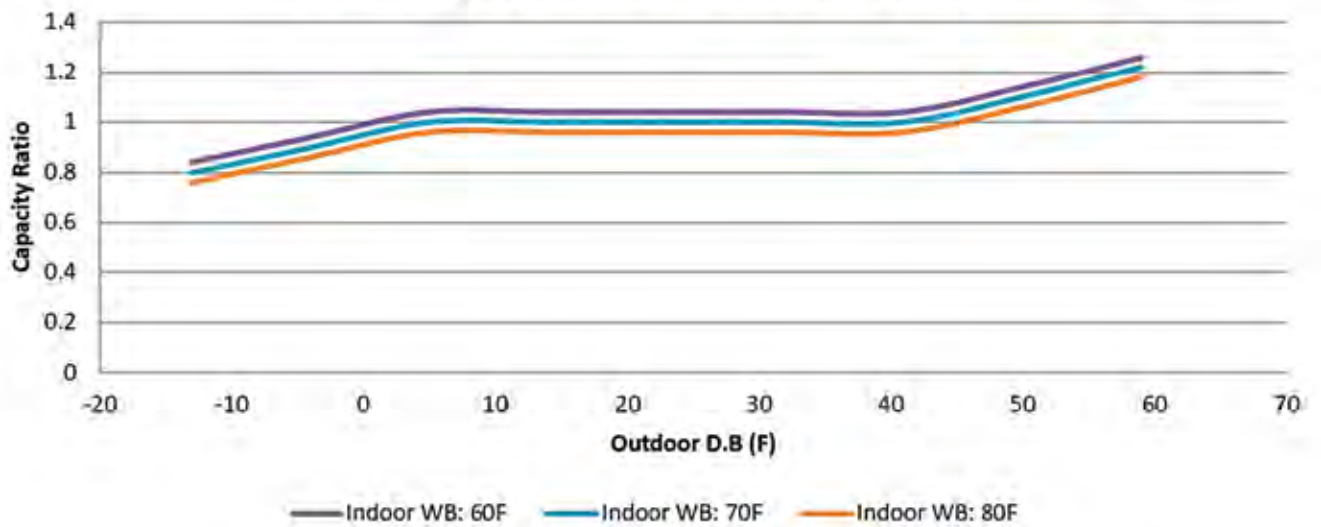

# External Dimensions: Nv-Series

Unit : inch

NTXWPH06A112AA, NTXWPH09A112AA,  
NTXWPH12A112AA, NTXWPH15A112AA,  
NTXWPH18A112AA, NTXWPH18A112AA

INDOOR UNIT

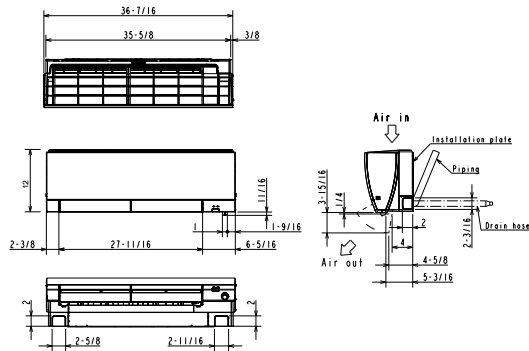

MSZ-EF09NA(W)(B)(S) MSZ-EF12NA(W)(B)(S)  
MSZ-EF15NA(W)(B)(S) MSZ-EF18NA(W)(B)(S)

INDOOR UNIT

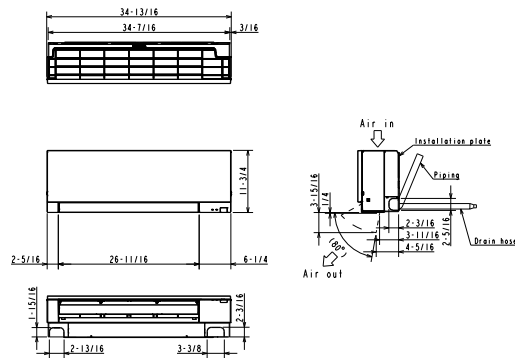

NTXWST06A112AA  
NT(X/Y)WST09A112A\*  
NT(X/Y)WST12A112A\*  
NT(X/Y)WST15A112A\*

INDOOR UNIT

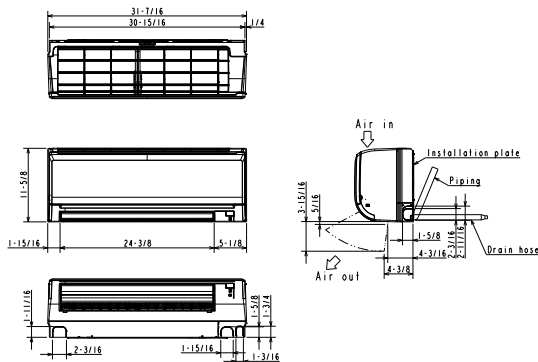

NTXWST18A112AA  
NTYWST18A112AA

INDOOR UNIT

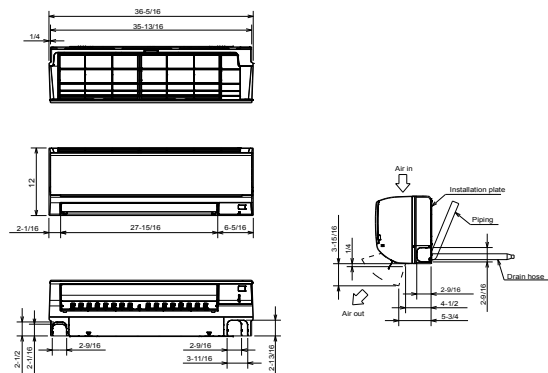

# Nv-Series

Unit : inch

## NT(X/Y)WST24A112A\*

### INDOOR UNIT

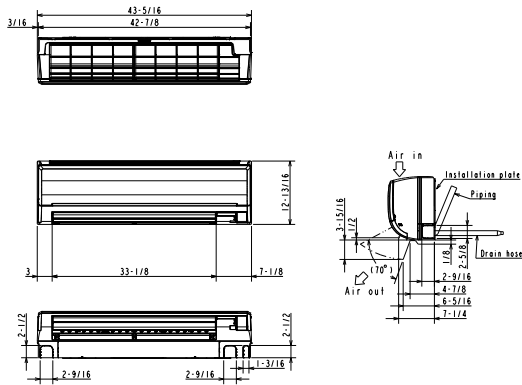

## NT(X/Y)WST(30/36)A112A\*

### INDOOR UNIT

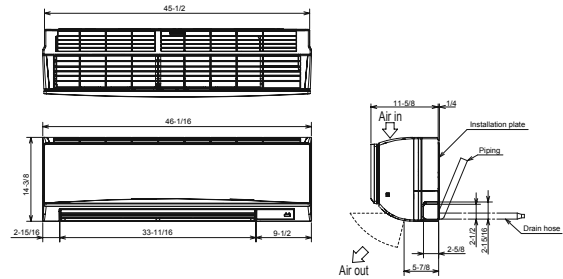

- NTXWMT09A112A\* NTXWMT09A111A\* NTXWEL09A112A\*  
 NTXWMT12A112A\* NTXWMT12A111A\* NTXWEL12A112A\*  
 NTXWMT15A112A\*

### INDOOR UNIT

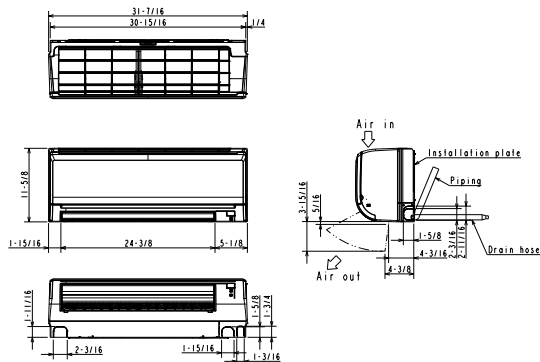

- NTXWMT18A112A\* NTXWEL18A112A\*  
 NTXWMT24A112A\* NTXWEL24A112A\*

### INDOOR UNIT

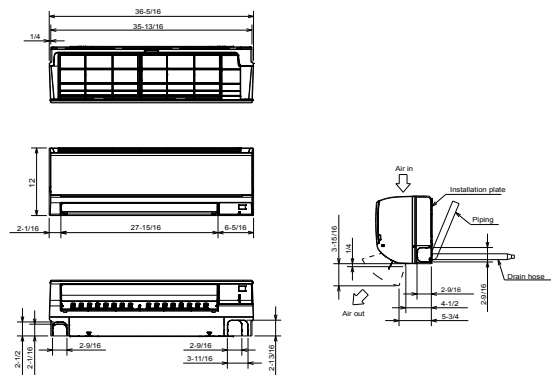



# Nv-Series

## INDOOR UNIT

NTXAMT12A112A\*  
 NTXAMT18A112A\*  
 NTXAMT24A112A\*  
 NTXAMT30A112A\*  
 NTXAMT36A112A\*

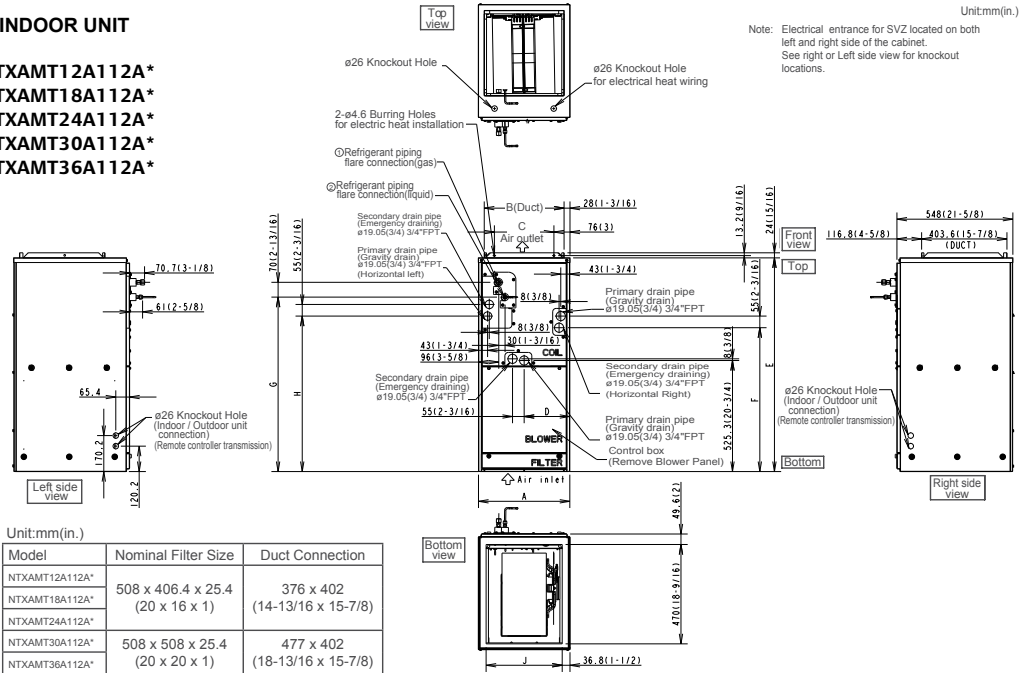

Model	Nominal Filter Size	Duct Connection
NTXAMT12A112A*	508 x 406.4 x 25.4 (20 x 16 x 1)	376 x 402 (14-13/16 x 15-7/8)
NTXAMT18A112A*		
NTXAMT24A112A*		
NTXAMT30A112A*	508 x 508 x 25.4 (20 x 20 x 1)	477 x 402 (18-13/16 x 15-7/8)
NTXAMT36A112A*		

Model	A	B	C	D	E	F	G	H	J	Gas Pipe	Liquid pipe
NTXAMT12A112A*	432 (17)	376 (14-13/16)	281 (11-1/8)	224 (8-7/8)	1,010.8 (39-13/16)	680 (26-13/16)	823 (32-7/16)	735.5 (29)	360 (14-3/16)	ø 9.52 (3/8) ø 12.7 (1/2)	ø 6.35 (1/4)
NTXAMT18A112A*										ø 15.88 (5/8)	ø 9.52 (3/8)
NTXAMT24A112A*											
NTXAMT30A112A*											
NTXAMT36A112A*											

## NTXUKS09A112A\* NTXUKS12A112A\* NTXUKS18A112A\*

### INDOOR UNIT

#### INDOOR UNIT OUTLINE DRAWING

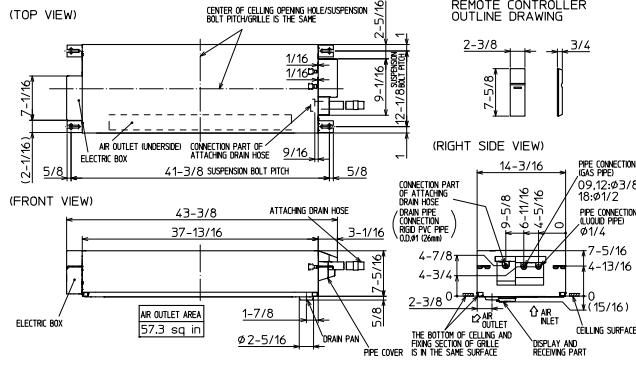

#### INDOOR UNIT DETAIL VIEW

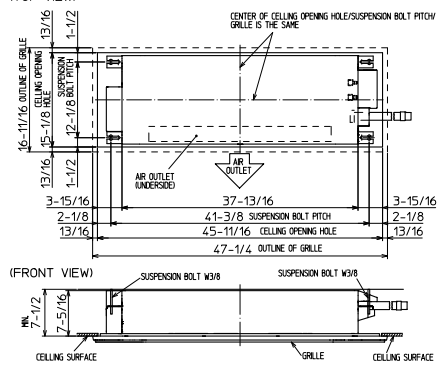

#### GRILLE OUTLINE DRAWING

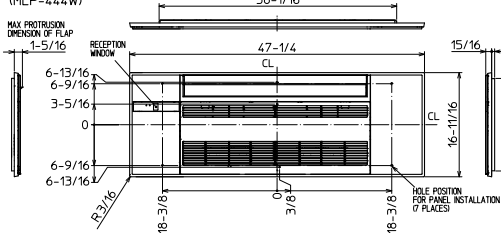

	KP09/12NA	KP18NA
EXTENSION PIPE	LIQUID PIPE O.D. ø1/4 GAS PIPE O.D. ø3/8	ø1/4 ø1/2
CONNECTION OF PIPE	LIQUID PIPE FLARED CONNECTION ø1/4 GAS PIPE FLARED CONNECTION ø3/8	FLARED CONNECTION ø1/4 FLARED CONNECTION ø1/2
DRAIN HOSE	HEAT INSULATOR O.D. ø1-1/4	CONNECTION I.D. ø1 EFFECTIVE LENGTH 18-7/8
DRAIN PIPE CONNECTION	RIGID PVC PIPE O.D. ø1 (26mm)	

NOTE: CUTTING ATTACHING DRAIN HOSE CAN BE USED.

#### THE METHOD FOR STANDING DRAIN FROM INDOOR UNIT

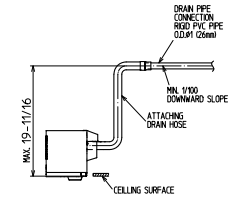

# Nv-Series

NTXFKS09A112A\*  
 NTXFKS12A112A\*  
 NTXFKS15A112A\*  
 NTXFKS18A112A\*

## INDOOR UNIT

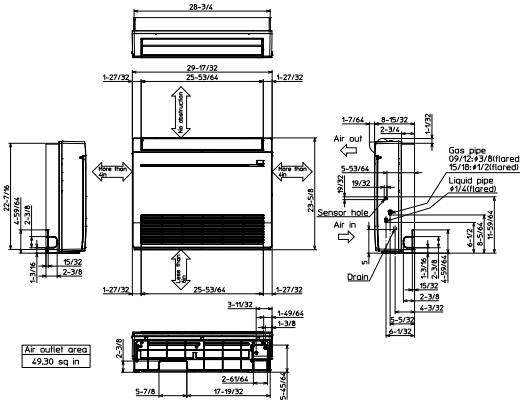

NTXSPH06A112A\*  
 NTXSPB06A112A\*  
 NTXSPH09A112A\*  
 NTXSPB09A112A\*  
 NTXSPH12A112A\*

NTXSST09A112A\*  
 NTXSST12A112A\*  
 NTXSST15A112A\*  
 NTYSST(09/12/15)A112A\*  
 NTYSST(12/15)A112A\*

NTXSMT09A111A\*  
 NTXSMT12A111A\*  
 NTXSEL09A112A\*  
 NTXSEL12A112A\*  
 NTXSEL18A112A\*

Unit : inch

NTXSMT09A112A\*  
 NTXSMT12A112A\*  
 NTXSMT15A112A\*  
 NTXSMT18A112A\*

NTXSPF09A112A\*  
 NTXSPF12A112A\*

## OUTDOOR UNIT

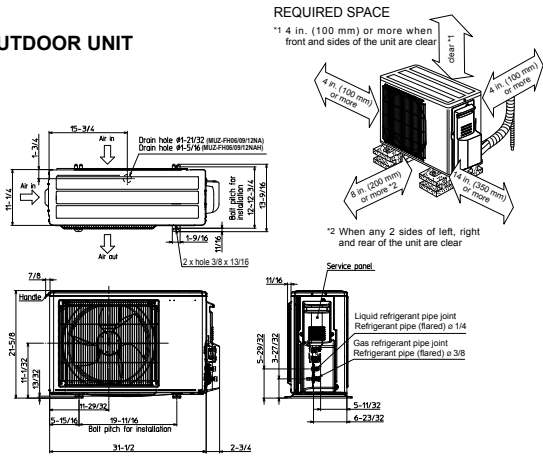

NTXSP(H/B)(15/18)A112A\*  
 NTXSPH18A112AA  
 NTXSST18A112AA  
 NTXSMT24A112AA  
 NTXSPF15A112AA

NTXSPB18A112AA  
 NTXSEL24A112AA  
 NTXSST18A112AA  
 NTXSPF18A112AA

NT(X/Y)WST(30/36)A112A\*

## OUTDOOR UNIT

## OUTDOOR UNIT

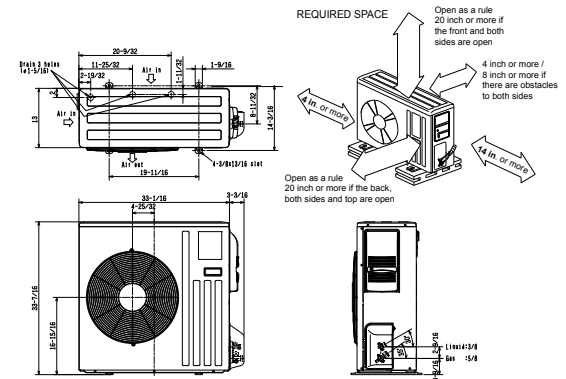
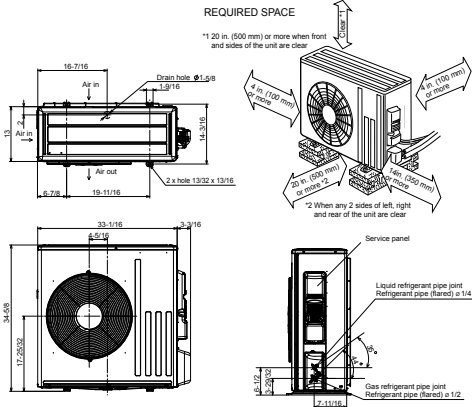

# Nv-Series

NTXCK09A112AA  
 NTXCK12A112AA  
 NTXCK15A112AA  
 NTXCK18A112AA

## INDOOR UNIT

Unit : inch/cm

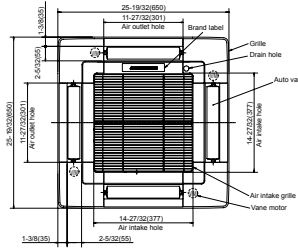
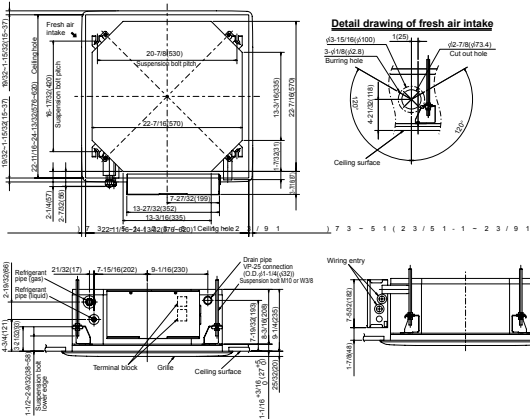

Models	Refrigerant pipe (liquid)	Refrigerant pipe (gas)
NTXCK09A112AA	1/4 inch (φ 6.35mm) flared connection	3/8 inch (φ 9.52mm) flared connection
NTXCK12A112AA	1/4 inch (φ 6.35mm) flared connection	3/8 inch (φ 9.52mm) flared connection
NTXCK15A112AA	1/4 inch (φ 6.35mm) flared connection	1/2 inch (φ 12.7mm) flared connection

NTXDKS09A112AA  
 NTXDKS12A112AA  
 NTXDKS15A112AA  
 NTXDKS18A112AA

## INDOOR UNIT

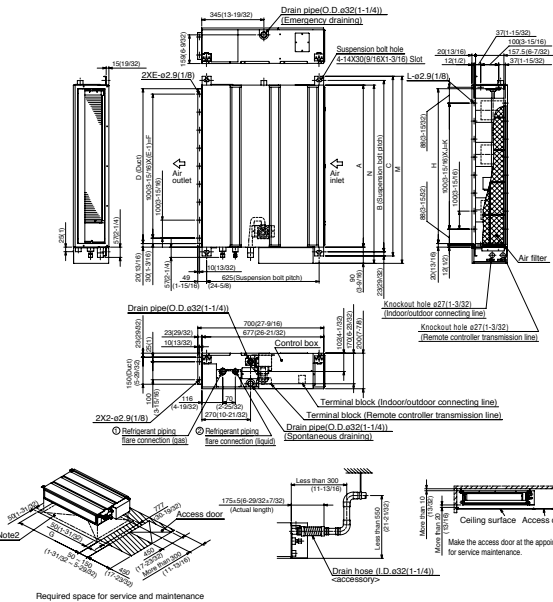

Model	A	B	C	D	E	F	G	H	J	K	L	M	N	O	Gas pipe	mm (in)
DKS09	170	232	798	860	7	800	800	860	5	200	16	818	270		ø6.35(1/4)	
DKS12	200	262	898	860	9	800	800	860	7	200	20	1538	898			
DKS15	1100	1150	1188	1360	11	1000	1000	1060	9	200	24	1528	1188		ø12.7(1/2)	
DKS18	1318	1368	1406	1580	11	1000	1000	1060	9	200	24	1528	1406			

Note1) Use M10 screw for the suspension bolt (field supply).  
 2) Keep the service space for the maintenance at the bottom.  
 3) This chart indicates for NTXDKS15A112AA model, which has 3 fans.  
 NTXDKS09A112AA, 12A112AA models have 2 fans.  
 NTXDKS18A112AA models have 4 fans.  
 4. In case an inlet duct is used, remove the air filter (supply with the unit), then install the filter (field supply) at suction side.



# External Dimensions: P-Series

Unit: inch/cm

## PLA-A12EA7 PLA-A18EA7 PLA-A24EA7 PLA-A30EA7 PLA-A36EA7 PLA-A42EA7 INDOOR UNIT

MODEL	12	18	24	30	36	42
PLA-A12EA7	12	18	24	30	36	42
PLA-A18EA7	18	18	24	30	36	42
PLA-A24EA7	24	18	24	30	36	42
PLA-A30EA7	30	18	24	30	36	42
PLA-A36EA7	36	18	24	30	36	42
PLA-A42EA7	42	18	24	30	36	42

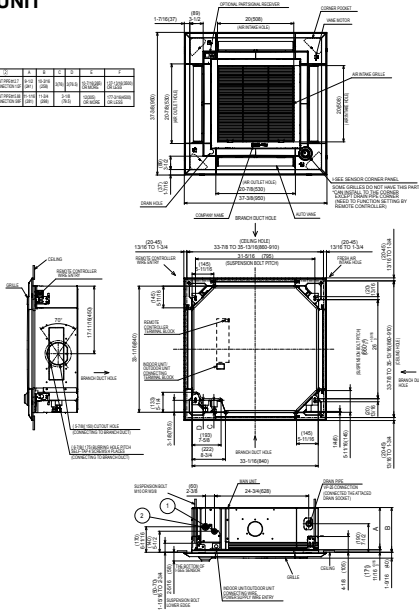

## PKA-A12HA7 PKA-A18HA7 INDOOR UNIT

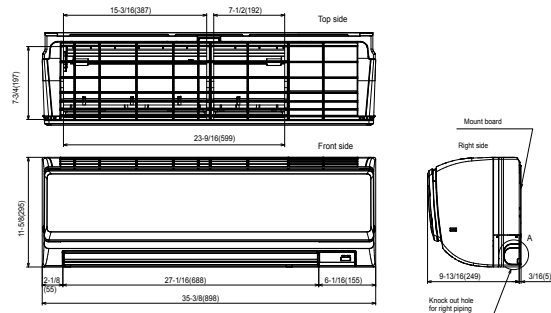

## PKA-A24KA7 PKA-A30KA7 PKA-A36KA7 INDOOR UNIT

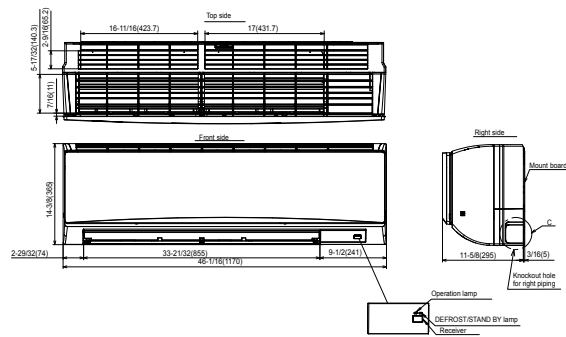

## PCA-A24KA7 PCA-A30KA7 INDOOR UNIT

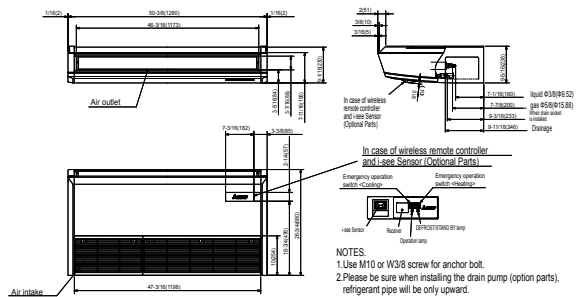

NOTES:  
1. Use M10 or W3/8 screw for anchor bolt.  
2. Please be sure when installing the drain pump (option parts), refrigerant pipe will be only upward.

# P-Series

## PCA-A36KA7 PCA-A42KA7 INDOOR UNIT

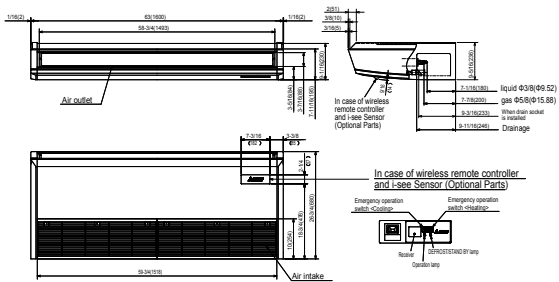

## PEAD-A09AA7 PEAD-A12AA7 PEAD-A15AA7 PEAD-A18AA7 PEAD-A24AA7 PEAD-A30AA7 PEAD-A36AA7 PEAD-A42AA7 INDOOR UNIT

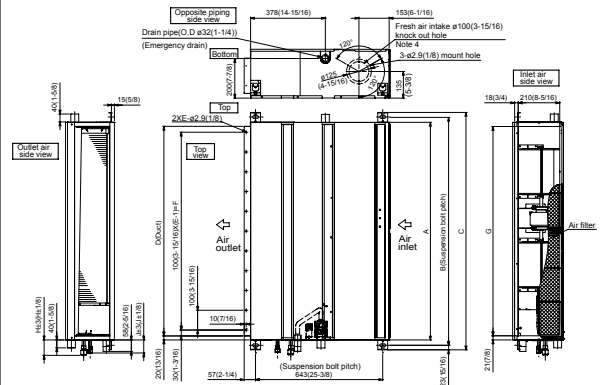

Unit:mm(in.)								Unit:mm(in.)			
Model	A	B	D	E	GF	G	H	Model	J	1 Gas pipe	2 Liquid pipe
PEAD-A12.18AA7	900 (35.716)	954 (37.516)	1000 (39.37)	900 (35.716)	8	800 (31.5)	858 (33.716)	PEAD-A12.18AA7	62 (2-1/2)	ø12.7 (1/2)	ø13.6 (1/4)
PEAD-A24.30AA7	1100 (43.307)	1154 (45.716)	1200 (47.24)	1050 (41.34)	11	1000 (39.37)	1058 (41.611)	PEAD-A24.30AA7	66 (2-5/8)	ø15.88 (5/8)	ø9.52 (3/8)
PEAD-A36.42AA7	1400 (55.118)	1454 (57.24)	1500 (59.116)	1350 (53.146)	14	1300 (51.181)	1358 (53.45)	PEAD-A36.42AA7			

## PVA-A12AA7 PVA-A18AA7 PVA-A24AA7 PVA-A30AA7 PVA-A36AA7 PVA-A42AA7 INDOOR UNIT

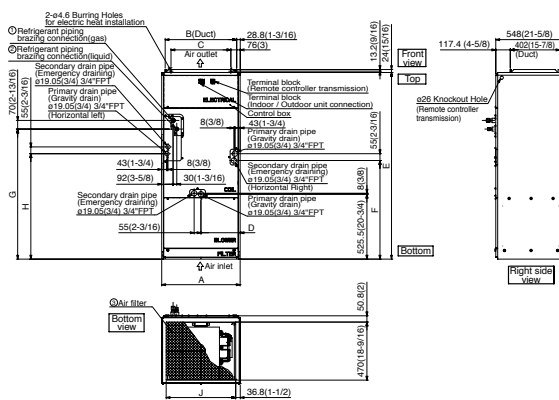

Model	ØNominal Filter size	Duct Connection
PVA-A30AA7	508X508X25.4 (20X20X1)	477X402 (18-13/16X15-7/8)
PVA-A36AA7	508X609.6X25.4 (20X24X1)	579X402 (22-13/16X15-7/8)

Model	A	B	C	D	E	F	G	H	J	Ø Gas pipe	Ø Liquid pipe
PVA-A30AA7	534 (21)	477 (18-13/16)	382.6 (15-1/8)	266.5 (10-1/2)	1378 (54-1/4)	737 (29-11/16)	953.5 (37-5/16)	792 (31-1/8)	461 (18-3/16)	Ø15.88 (5/8)	Ø9.52 (3/8)
PVA-A36AA7	635	579	484.6	317.5	1511	788.5	1053	853.5	503		
PVA-A42AA7	(25)	22-13/16	(18-1/8)	(12-1/2)	(59-1/2)	(31-7/16)	(41-1/2)	(33-5/8)	(22-3/16)		



# P-Series

PUZ-A12NKA7 PUZ-A12NKA7-BS  
 PUZ-A18NKA7 PUZ-A18NKA7-BS  
 PUY-A12NKA7 PUY-A12NKA7-BS  
 PUY-A18NKA7 PUY-A18NKA7-BS

## OUTDOOR UNIT

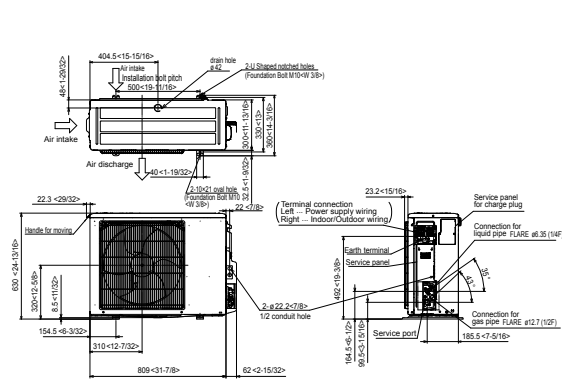

PUZ-A24NHA7 PUZ-A24NHA7-BS PUZ-HA24NHA  
 PUZ-A30NHA7 PUZ-A30NHA7-BS  
 PUY-A24NHA7 PUY-A24NHA7-BS  
 PUY-A30NHA7 PUY-A30NHA7-BS

Unit : inch/cm

## OUTDOOR UNIT

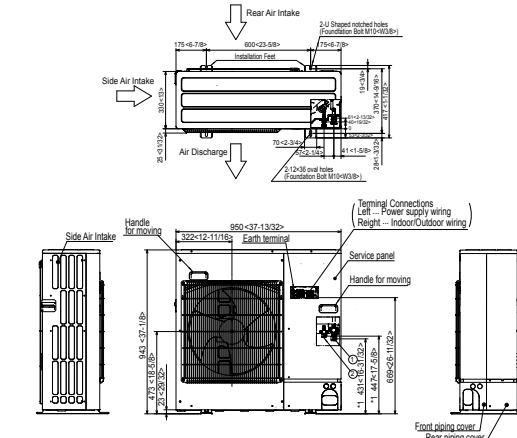

### Example of Notes

- ① --- Refrigerant GAS pipe connection (FLARE)φ15.88×5/8"
- ② --- Refrigerant LIQUID pipe connection (FLARE)φ9.52×3/8"
- \*1 --- Indication of STOP VALVE connection location.

PUZ-A36NKA7 PUZ-A36NKA7-BS  
 PUZ-A42NKA7 PUZ-A42NKA7-BS  
 PUY-A36NKA7 PUY-A36NKA7-BS  
 PUY-A42NKA7 PUY-A42NKA7-BS

## OUTDOOR UNIT

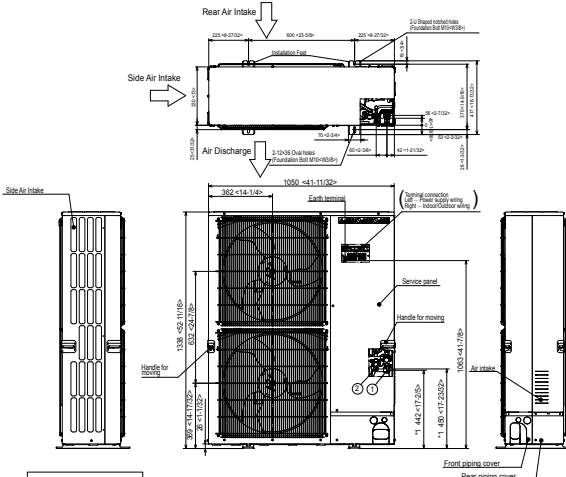

### Example of Notes

- ① --- Refrigerant GAS pipe connection (FLARE)φ15.88×5/8"
- ② --- Refrigerant LIQUID pipe connection (FLARE)φ9.52×3/8"
- \*1 --- Indication of STOP VALVE connection location.

PUZ-HA30NHA5  
 PUZ-HA36NHA5

## OUTDOOR UNIT

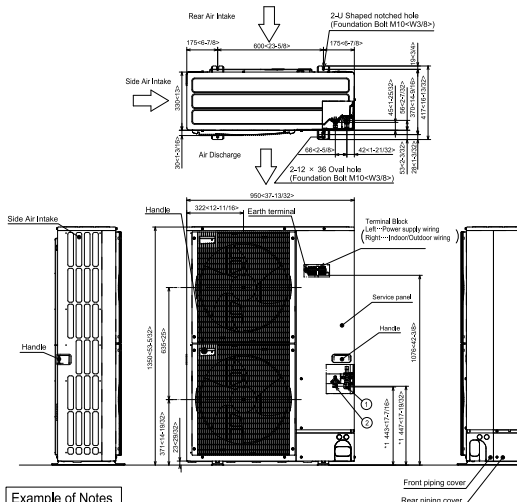

### Example of Notes

- ① --- Refrigerant GAS pipe connection (FLARE)φ15.88×5/8"
- ② --- Refrigerant LIQUID pipe connection (FLARE)φ9.52×3/8"
- \*1 --- Indication of STOP VALVE connection location.



# External Dimensions: MX Model

Unit : inch/cm

## NTXMMX20A122A\*

### OUTDOOR UNIT

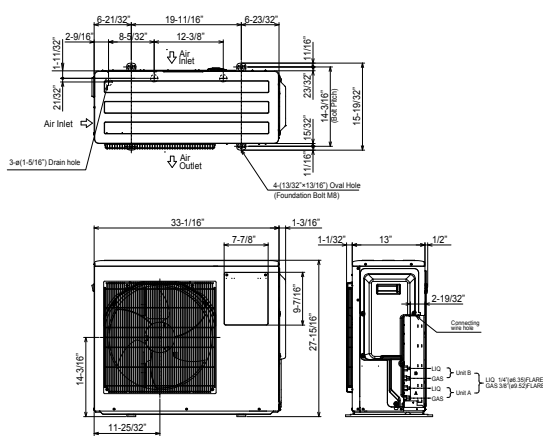

## NTXMMX24A132A\* NTXMMX30A132A\* NTXMMX36A142A\*

### OUTDOOR UNIT

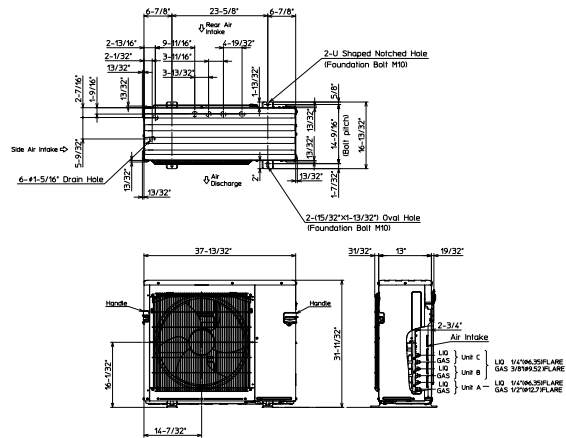

## NTXMMX42A152A\* NTXMPH20A122A\* NTXMPH24A132A\* NTXMPH30A132A\*

### OUTDOOR UNIT

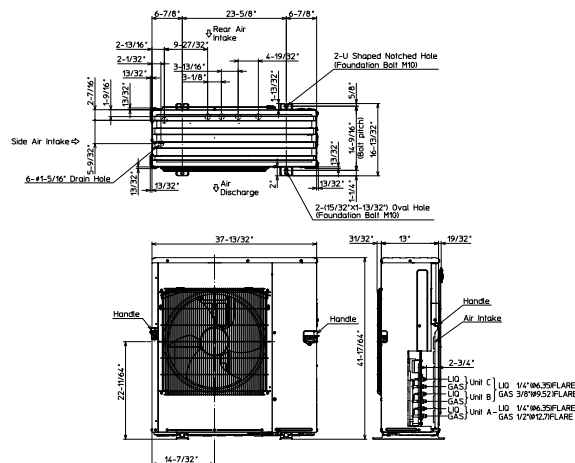

## NTXMMX48A182A\* NTXMMX60A182A\* NTXMPH36A142A\* NTXMPH42A152A\* NTXMPH48A182A\*

### OUTDOOR UNIT

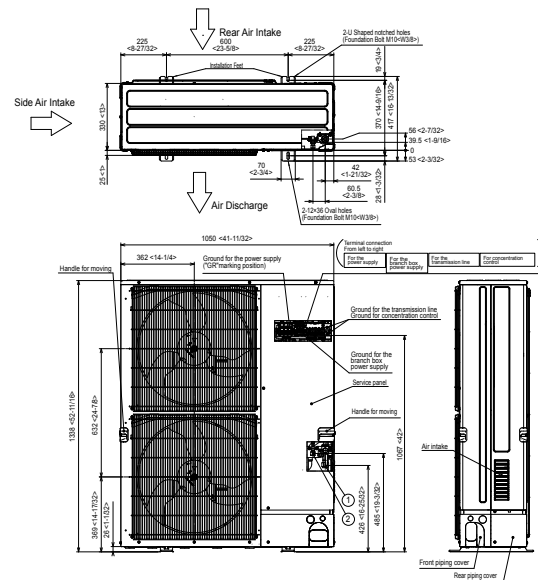

#### Example of Notes

- ① --- Refrigerant GAS pipe connection (FLARE)ø15.88-5/8"
- ② --- Refrigerant LIQUID pipe connection (FLARE)ø9.52-3/8"

# MX Model

Unit : inch/cm

## TAC-MKA31BC

### Branch Box

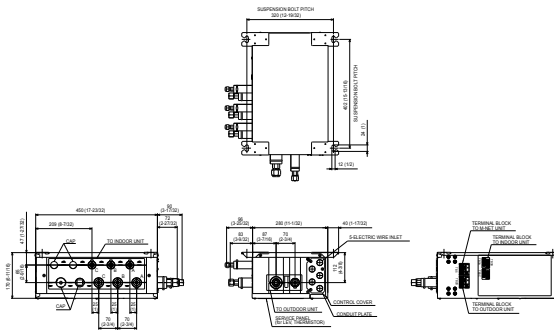

SUSPENSION BOLT: 1/2 (12.7) (M10)

REFRIGERANT PIPE FLARED CONNECTION

	A	B	C	TO OUTDOOR UNIT
LIQUID PIPE	1/2" (12.7)	1/2" (12.7)	1/2" (12.7)	3/8" (9.5)
GAS PIPE	3/8" (9.5)	3/8" (9.5)	3/8" (9.5)	5/8" (15.9)

LINE INCH

## TAC-MKA51BC

### Branch Box

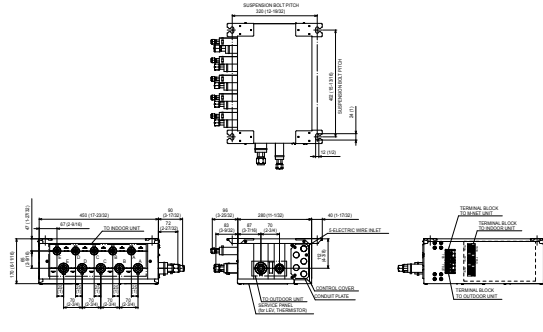

SUSPENSION BOLT: 1/2 (12.7) (M10)

REFRIGERANT PIPE FLARED CONNECTION

	A	B	C	D	E	TO OUTDOOR UNIT
LIQUID PIPE	1/2" (12.7)	1/2" (12.7)	1/2" (12.7)	1/2" (12.7)	1/2" (12.7)	3/8" (9.5)
GAS PIPE	3/8" (9.5)	3/8" (9.5)	3/8" (9.5)	1/2" (12.7)	5/8" (15.9)	

LINE INCH

for a greener tomorrow



Eco Changes is the Mitsubishi Electric Group's environmental statement, and expresses the Group's stance on environmental management. Through a wide range of businesses, we are helping contribute to the realization of a sustainable society.

**⚠ NOTICE**

Do not install indoor units in areas (e.g. mobile phone base stations) where the emission of VOCs such as phthalate compounds and formaldehyde is known to be high as this may result in a chemical reaction

Our air-conditioning equipment and heat pumps contain a fluorinated greenhouse gas, R410A

When installing or relocating or servicing our air-conditioning equipment, use only the specified refrigerant (R410A) to charge the refrigerant lines

Do not mix it with any other refrigerant and do not allow air to remain in the lines

If air is mixed with the refrigerant, then it can be the cause of abnormal high pressure in the refrigerant lines, and may result in an explosion and other hazards

The use of any refrigerant other than that specified for the system will cause mechanical failure, system malfunction or unit breakdown. In the worst case, this could lead to a serious impediment to securing product safety

© 2020 Mitsubishi Electric Trane HVAC US LLC. All rights reserved.

Mitsubishi Electric, Lossnay, and the three-diamond logo are trademarks of Mitsubishi Electric Corporation. CITY MULTI, kumo cloud, kumo station and H2i are registered trademarks of Mitsubishi Electric US, Inc. Trane and American Standard are registered trademarks of Trane Technologies plc. All other product names mentioned herein are trademarks or registered trademarks of their respective owners.

ENERGY STAR and the ENERGY STAR mark are registered trademarks owned by the United States Environmental Protection Agency.

Use of the AHRI Certified® mark indicates a manufacturer's participation in the certification program. For verification of certification for individual products, go to [www.ahridirectory.org](http://www.ahridirectory.org).

Specifications shown in this brochure are subject to change without notice. See complete warranty for terms, conditions and limitations. A copy is available from Mitsubishi Electric Trane HVAC US LLC.

Printed in the USA

SKU: TR\_RS\_1060\_02-20



[www.trane.com/ductless.com](http://www.trane.com/ductless.com)



Please Recycle