

Systems from Trane[®] are good for business

System overview

p. 3

When does ice storage make sense?

p. 8

Life-cycle analysis

p. 10

How much ice?

p. 12

How much chiller?

p. 14

Adding ice to a chilled-water system

p. 15

Standard configurations

p. 16

Support features

p. 18

System component specifications and performance data

p. 24

Quick Select Guides

p. 32

Trane takes a comprehensive approach to HVAC system design that supports what is best for your building, right for the environment and good for your bottom line.

Cooling without compromises. Trane delivers prepackaged operational efficiencies that support sustainable building performance making it easy to do the right thing. Trane systems leverage high-efficiency HVAC equipment and advanced controls to optimize whole system design and operation.

Energy prices are uncertain, but trends are not. With even higher energy costs on the horizon, owners should be making plans to mitigate the impact on operating expenses. An obvious place to start is with one of the biggest energy consumers in the building: the cooling system. Adding thermal energy storage to an HVAC system can reduce energy costs associated with comfort cooling by shifting equipment operation from high- to low-cost times of day.

The Trane Thermal Battery™ Air-cooled Chiller Plant simplifies the design and implementation of thermal storage systems. This means you can take advantage of the one component of energy pricing that has not gone up in 30 years—off-peak electricity.

The one component of energy pricing that has not gone up in 30 years is off-peak electricity.

Smart meters and demand response programs are coming to a utility near you.

With thermal storage in place, you are ready to respond to these signals or events, without compromising your building operations. Having the capability to respond to energy signals or scarcity allows you to play an active role in controlling the energy costs for your facility. You also contribute to national energy security by helping all of us work together to use our energy resources wisely.

Supporting renewable energy. By shifting energy use to times when renewable energy is available, thermal storage systems contribute significantly to the emerging vision of energy in the future. Energy storage doesn't have to be an industrial power battery made out of expensive, cutting-edge materials. It can be as simple as a few ice tanks on every mid- to large-scale cooling system. Today's ice storage systems are more cost optimized and flexible than ever.

Thermal energy storage can work in tandem with other renewable energy systems. In many locations suitable for capturing wind energy, the wind blows hardest at night. That electricity generation is not good timing for a building, unless it uses thermal energy storage. Conversely, solar energy must be converted during the day, when electricity generation may be strained both by cooling equipment demand and by reductions in turbine generation performance. By shifting energy for cooling to nighttime hours, we can not only capture green energy from the wind, but we also offload its burden on solar energy during the day.

Trane® Thermal Battery™ Air-cooled Chiller Plant

The Trane Thermal Battery Air-cooled Chiller Plant includes eight standard configurations for air-cooled chillers, ice tanks and customizable system controls that provide an advanced starting point for designing an ice storage system.

Trane has engineered and developed this prepackaged system based on previous successes. Approximately 80 percent of the installed ice storage projects use air-cooled chillers and internal melt modular ice tanks. By limiting the scope to a specific style of chiller, the appropriate type of ice storage system can be readily identified.

Identifying the repeatable aspects of these designs allows us to compress the time it takes for the system to go from the idea phase to the commissioning phase. System completion packaged skids, preprogrammed control sequences, operator graphics and drawings are some of the features developed to support this system.

Trane provides, supports, and deploys energy modeling during the system design phase. Trane Air-conditioning Economics (TRACE®) software can be used to determine whether this system can be expected to help your building earn high performance designation.

System package benefits

Reduced risk and engineering costs

- Preprogrammed system controls
- Pre-engineered system packages

Repeatability

- Avoid installation and commissioning pitfalls
- Avoid or reduce custom programming
- Simplify maintenance with repeated elements across many installed systems

Optimized components

- Least expensive first-cost system
- Lowest total cost of ownership system
- System expansion in the most appropriate way (more chiller, or more tank?)

Reliability

- CALMAC® Ice Bank® tanks have no moving parts
- Ice provides partial system redundancy, minimizing assets to maintain

A little history ...

Trane has been educating the industry for decades on chiller-based thermal storage systems. Refrigeration itself began as an ice storing and melting application, which is why cooling is rated in tons. So it's appropriate that a natural element such as frozen water and its capacity for storing thermal energy can and should be tapped again for Earth-friendlier cooling.

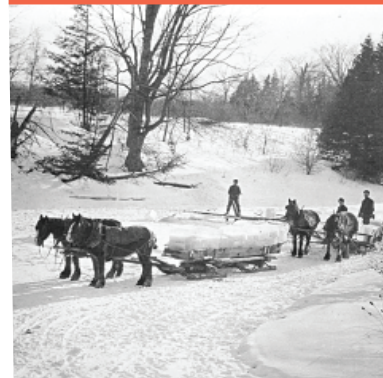

Better together for simplified off-peak cooling

Air-cooled chillers fit well with ice storage. This system from Trane® delivers water-cooled, chilled-water system performance without water-cooled complexity while costing the same or only slightly more than a traditional chilled-water system.

Efficiency

- Air-cooled chillers use compressors well suited for making ice, with a low performance penalty when not making ice.
- Using cold fluid and cold air reduces transfer energy in fans and pumps, and sheet metal and piping costs can be reduced.
- Electric grid efficiency is improved by allowing a utility to have less “spinning reserves” idling and wasting energy.
- Natural gas turbines are more efficient at night than during the day, saving energy.

Cost

- By using ice as part of the system redundancy, chiller size can be reduced, which offsets much of the cost of adding ice storage tanks to a partial storage project.
- By using cold fluid and cold air, fans, pumps, and ductwork can be right sized in a trade-off with energy costs.

- In many climates, air-cooled chillers may use glycol in the evaporator already to prevent freezing during cold weather, so the cost of glycol is already included.
- Ice storage is a lot less expensive per ton-hour than chilled-water storage for small to medium sized systems.

Flexibility

- Easy conversion to add ice-making capability to existing air-cooled chillers.
- Chiller plants with ice storage allow for operational flexibility; the cooling is created when it makes sense, not necessarily when it is used.

Standardized system designs

- By making decisions about the system design, the common options are easier to accommodate in system controls. These controls are then standardized to help reduce opportunities for errors and reduce custom control programming.
- The System Completion Module is a Trane-designed, -built and functionally tested skid that reduces design and installation time, lowers the system complexity, and standardizes maintenance with parts identification and warranty by a single provider.

Typical electric load make-up

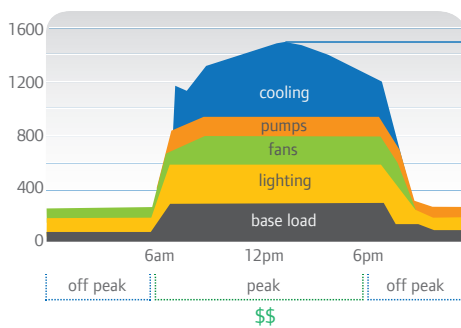

Electric load profile with thermal storage

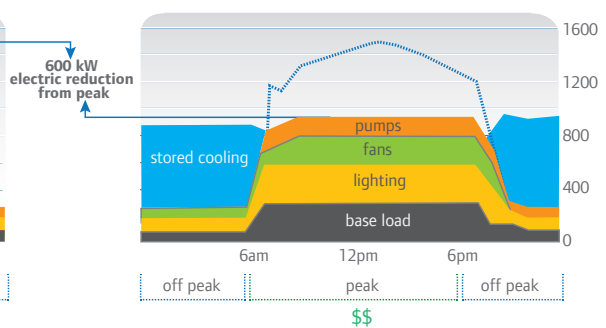

“We have found project simple paybacks of as little as two years, always less than four years. Over the anticipated life of the school of 40 years or more, we believe the total savings could be as great as \$1.2 million in a typical middle school.”

Johnston County Schools



- A** **Trane® air-cooled chillers** with built-in ice storage support provide water-cooled efficiency without the added cost, maintenance and complexity of a water-cooled system.
- B** **CALMAC® Ice Bank® thermal energy storage tanks** offer pre-engineered, factory-built reliability with tested, efficient and repeatable performance.
- C** **System completion module** provides single-source responsibility. Each module includes a pre-engineered pumping system, single point power and control connection, factory mounted Trane controls, installation logistics, start-up and commissioning coordination, and warranty/technical support.

Why modular ice tanks?

Pre-engineered, factory-built reliability and documented performance. Factory-built modular ice tank performance is documented, tested and repeatable over the life of the system. The net usable ton hours of a modular, standardized tank are known. In contrast, field-built ice tank performance is unknown. The cylindrical shape of the CALMAC® tank is stronger and the high density polyethylene construction with thermal welds is very durable. There are no moving parts and the tank is 99 percent recyclable.

Why internal melt ice tanks?

Internal melt tanks like the CALMAC Ice Bank® do not send melt water out to the load coils. An intermediate medium such as glycol is used in a closed loop between the tanks and the chiller. An optional heat exchanger can be easily added to separate the glycol loop from the water loop if needed. Alternatively, glycol can be sent all the way to the load coils, especially in smaller systems. Here are just a few key benefits of internal melt ice tanks.

Efficiency (warmer charge temperatures).

Counter-flow heat exchanger provides consistent temperatures throughout the tank for repeatable optimum charge and discharge performance. Average ice build is ½ inch for efficient charging performance.

In contrast, an external melt coil will make ice through ice, and require a lower charge temperature and more chiller energy.



No agitation required. External melt tanks are more prone to ice bridging and capping. A bridge joins adjacent tubes with ice, preventing the efficient flow of water for melting. A cap is a block of ice that pushes up and out of contact with the coil surface. Both bridging and capping reduce the net usable capacity of the ice, unless agitation is used to stir the tank and create more uniform ice production and melting.

Charge while cooling. This mode is not possible with external melt tanks, because the fluid melting the ice is the fluid going through the chiller. It's not possible to melt ice while you're simultaneously building ice. However, peak (instantaneous) tons discharged will be lower with internal melt tanks.



All models of Trane® air-cooled chillers can be deployed into a Trane Thermal Battery™ air-cooled chiller plant.

Why air-cooled chillers?

Designed for ice-making efficiency. With few exceptions, air-cooled chillers use positive displacement compressors: screw and scroll technology. They are readily capable of creating the extra head pressure required on ice storage systems, and are especially efficient at night when the outdoor dry-bulb temperatures are suppressed. The change in outdoor dry bulb from day to night is typically more drastic than the change in outdoor wet bulb, which gives air-cooled equipment more efficiency improvement at night than water-cooled equipment.

Lower system cost. This system is simpler and therefore costs less to engineer and install, with lower cost components. Because an air-cooled system is typically smaller, it's also easier to package and pre-engineer, with few options that take extra time to properly consider. Air-cooled chillers are often regularly selected to cool anti-freeze solutions, to protect them while operating in cold climates, so the cost of glycol may already be included.

Simplicity. Smaller, air-cooled systems are not as complex and require fewer maintenance tasks. As the systems get larger, water-cooled systems make more sense because water-cooled chillers are available in higher capacities.

Why use a variable-speed air-cooled chiller in an ice storage system?

Even better efficiency. Variable-speed chillers with ice are 20-30 percent more efficient during daytime operation than other air-cooled chillers with ice, leading to a further reduction in both energy and energy cost. For partial storage systems, even the most downsized chiller will not run fully loaded during the on-peak period, except on days with the maximum expected cooling load. Trane chillers have an ideal combination of ice making capability with efficiency that does not diminish when operated at part-load during daytime operation.

Lower sound. Variable-speed chillers are quieter than other air-cooled chillers, so applying them in sound sensitive applications may mean the difference between wanting full storage (having the chillers off during certain parts of the day) and a less expensive partial storage system. In addition, the variable-speed chiller can be asked to make ice while still having its premium sound option active.

When does ice storage make sense?



There are number of reasons to bring ice storage into the system design discussion as we previously addressed. The real question is: When does it make sense? The answer should be: When it has the lowest life-cycle cost compared to alternative systems, and fits within the budget. There are a number of economic analysis tools readily available.

The easiest way to include ice storage and stay within budget is to use air-cooled chillers, not too many tanks, and a downsized chiller. However, the lowest life-cycle cost system may include more tanks and larger chillers and cost more to install. Whether the preferred larger system is affordable today can be determined by the availability of incentives or rebates from one or a number of sources.

Off-peak cooling using ice storage is not for everyone. The following are key considerations.

Are you seeking green building designation? High-performance building designation steers the discussion toward systems that have lower energy costs. How much can an ice storage system reduce annual energy? Ice storage systems can earn up to six LEED® points (depending on the baseline system and local utility rates), as well as LEED Pilot Program points (one or two). For projects following ASHRAE® 189.1 (the high performance green building standard), ice storage can help satisfy the prescriptive requirement in 7.4.5.1 Peak Load Reduction.

“Building projects shall contain automatic systems, such as demand limiting or load shifting, that are capable of reducing electric peak demand of the building by not less than 10% of the projected peak demand. Standby power generation shall not be used to achieve the reduction in peak demand.”

How much does it cost up front? It may cost more to install than you think you can afford, though you may be able to get the system cost in budget by using the right design. It’s easier to justify an ice storage system when improvements to your system are planned, and if you already have a chilled-water system in place or planned. The incremental cost is the key.

Depending on the shape of your design-day load profile, a downsized chiller can be the right fit if you’re able to use the ice for a portion of the customary system redundancy allowance. The figure below shows a chiller sized to handle the design-day peak load only when supplemented with ice. The load profile allows for tanks to be charged after the coincident cooling loads have diminished.

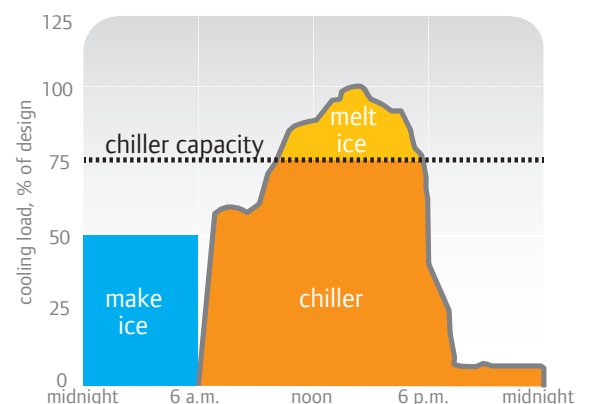

For more information on ice storage for LEED projects, refer to Trane® *Engineers Newsletter* volume 36-3 (2007). Visit trane.com.

What are the electric rates and are there incentive programs? Electric rate structures in many areas are suitable for ice storage. In some cases, the electric rate structure necessary for ice storage to reduce energy cost is one that you're not subscribed to right now. This can be as simple as a call to the local utility company to find out what electricity rates are available, and if there are rebates or other incentives in your area for off-peak cooling.

Generally speaking, ice storage should be considered when one or more of the following exist in your electricity rate structure.

- Demand charges greater than \$6 per kW
- Daytime energy is \$0.06 per kWh more expensive than night time energy
- Flat rate ("negotiated pricing") accounts for the load profile during negotiations
- Load profile penalties (i.e., stepped rates, kWh/kW floating cutoffs, "Hours of Use Demand")
- Demand ratchet clauses ("larger of monthly demand or 80 percent of previous 12-months' demand")
- Real time pricing (look ahead signal of electricity costs, changes as often as every 15 minutes)
- Curtailment rates (agreeing to reduce power use when a load reduction is requested)

What is the cooling load profile? The hours in the day when the chiller isn't at full capacity are used to recharge the ice tanks. You may not have a cooling load that varies enough throughout the day to accommodate storing cooling energy. If the load-profile is flat, larger chilled-water storage systems may become attractive, especially if the system requires a high degree of redundancy, such as a data center or a manufacturing process. Life-cycle analysis should account for year-round cooling loads. The graph below shows a cooling load duration curve. The shape of the curve tells you how many ton-hours are setting your on-peak electricity costs. A larger system would satisfy more of system peak cooling requirements.

Do I have other reasons for storage such as limited or unreliable electricity? Some buildings are constrained by the consistent availability of electricity. Examples include buildings in areas that suffer from regular brownouts and blackouts, facilities switching from steam-driven to electric chillers, buildings in formerly rural areas without adequate infrastructure, or those with onsite power generation. Ice storage can be part of the solution because it requires less peak energy generation and smaller emergency generators.

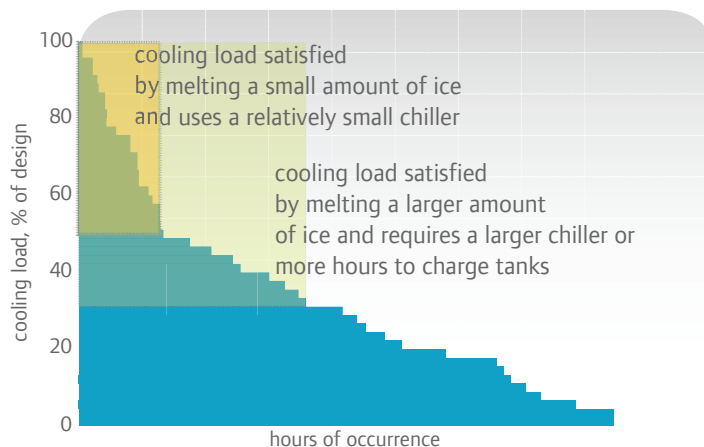

Sample life-cycle analysis



The following energy and annual operating costs were calculated using TRACE® for a mid-sized, 275-ton office building in San Jose, California. The ASHRAE® 90.1 baseline is at the far left, with various system options charted to the right.

Site energy consumption. The chilled-water system options all save energy over the energy code baseline chiller system. (See *Site energy* graph below.) The Trane® Thermal Battery™ air-cooled chiller system at the far right uses more site energy than the water-cooled chiller systems. However, for a comprehensive evaluation of ice storage, we must continue the analysis and consider source energy, first cost and overall operating costs.

Source energy consumption is fuel energy used to create the electricity. Because power generation equipment is less efficient on hot summer days, converting site energy to source energy better reflects the overall energy consumed. (See *Source energy* graph below.)

The air-cooled ice storage system has source energy use comparable to a water-cooled, chilled-water system without ice storage.

**TRACE energy analysis:
Cooling equipment site energy (kBtu)**

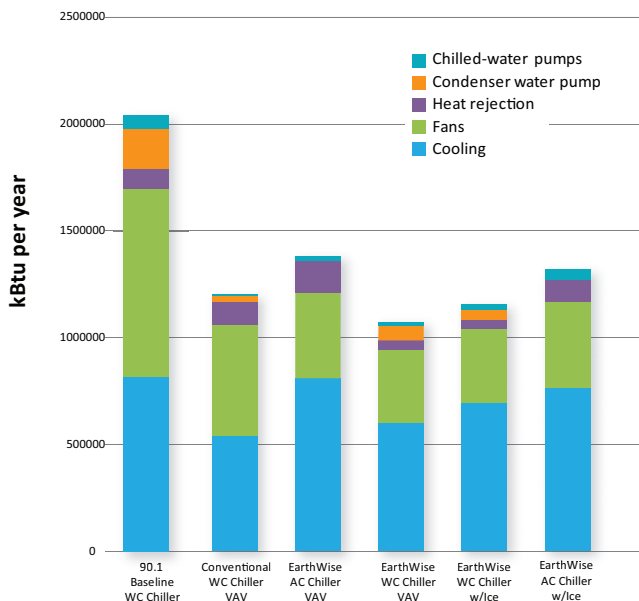

**TRACE energy analysis:
Cooling equipment source energy TDV (kBtu)**

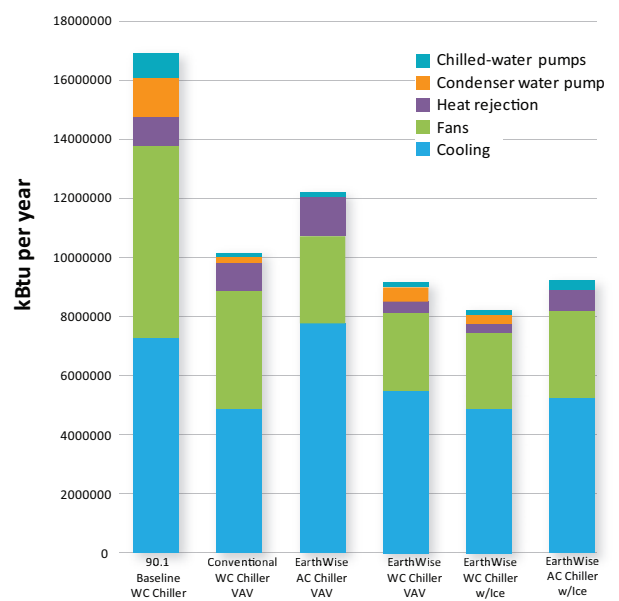

System costs. Annual operating costs include energy, maintenance and water costs. (See *life-cycle* graph below.) First costs include the equipment and installation costs of the system. Life-cycle costs include all revenue and cost streams for 20 years, including economic factors such as inflation and tax implications.

For this particular combination of building, climate, and utility tariff, the Trane® Thermal Battery® air-cooled chiller system had the lowest first cost and the lowest total cost of ownership of all the alternatives.

For LEED® designation, this system would have earned approximately two points for energy cost savings and would help with water conservation credits. In addition, a LEED 2009 pilot program allows for an additional one to two points for ice-storage systems, depending on how the building automation system responds to utility signals.

Life-cycle analysis demonstrates 14 -20 percent energy cost savings.

- Two to three LEED points
- One to two LEED pilot points
- Plus help on water credits (for more points don't downsize pipes or ducts)

TRACE® life-cycle analysis: Annual operating expense, full building



How much ice?



The following considerations will drive the number of tanks to install.

Chiller capability and charge time.

An existing chiller retrofit for ice storage has a defined maximum flow rate that determines the number of tanks it can charge. The number of hours available for charging tanks may also limit the number of tanks that could be purchased.

Budget. The budget alone can determine how many tanks to purchase. If too few tanks are purchased, the final charge temperature may require more glycol solution. You also might consider downsizing your chiller. In any case, system redundancy should be considered, which leads to the next topic, operational flexibility.

Operational flexibility requirements. If your only ice making chiller shuts down unexpectedly, and it's your only chiller, and there is a critical cooling load, let's hope it happened when stored ice is available for cooling. If it did, you may have eight hours or possibly several mild days to resolve the problem before you run out of ice. The desire for complete redundancy may lead to the purchase of another chiller (n+1), a back-up cooling system for critical loads, or preinstalled rental chiller piping connections.

Power constraints. You may design your system to ride through a power disturbance or an outage with the chiller off to meet the critical loads or the minimum amount of cooling. Or, the system size can be dictated by on-site power generation or available utility power.

Energy saving strategy. Partial storage means the chiller(s) will be supplemented with ice melting during the discharge period. Partial storage is usually selected for long on-peak windows (6-8 hours or more) and lowest first cost. Partial storage can have the lowest life-cycle cost especially when rebates are unavailable, and/or when the chiller is already purchased or being retrofitted for ice making. Partial storage is an excellent peak shaving strategy when high on-peak demand charges (\$8 or higher) and/or ratchet clauses are in place.

Full storage means that the chiller(s) will be off during the discharge period. Full storage is used for short on-peak windows (2-4 hours) and maximum load-shifting strategies, especially when rebates are based on shifted ton or shifted kW. Full storage provides more benefit when a large difference between on- and off-peak kWh charges (such as a \$0.10 difference per kWh) drive the strategy to maximum load shift.

Space limitations. Sometimes the number of tanks is determined by the amount of available space. This is more of a concern on water-cooled systems that can utilize more tanks than with smaller, air-cooled systems. But given the financial incentives of off-peak cooling, previously unavailable space may become available.

Knowing either the number of tanks or the chiller size allows easy preliminary selection using the information on pp. 32-35. The number of hours to charge the tanks narrows the list of possibilities. When more about the project is known, CALMAC® IcePick™ and Trane® Select Assist™ chiller selection software are used for final system design.



Four tanks occupy the space initially planned for a second chiller.

How much chiller?



Determining how much of the on-peak load should be met with ice storage is arbitrary, and is typically dictated by the cooling load profile and the objectives of the designer or building owner. A common starting point is 30 to 40 percent of the design day cooling load. As more of the building load is served by ice storage, on-peak chiller capacity and building electrical demand are reduced. However, more ice needs a larger chiller to charge the tanks in the same length of time. There is a balance to be struck.

Greater ice storage capacity requires greater chiller ice-building capacity. One solution that's easy to find mathematically is the ice storage capacity that results in a chiller working as hard as it can during the day, while still being able to charge all the tanks at night. While this selection results in the smallest chiller net capacity, it does not necessarily represent the best life-cycle cost system. TRACE® software can help you determine if a larger system is economically justified.

Possible starting points:

- Maximum number of tanks your chiller can charge in the amount of available hours (maximum freeze time)
- Smallest chiller needed on a design day, with or without an ice contribution (minimum melt rate)
- Electrical constraint for the chiller on a design day
- Maximum number of tanks you are prepared to put on site

Visualize the options

The following two figures show a load profile and two different options for the amount of the design day load that is to be met with the stored ice.

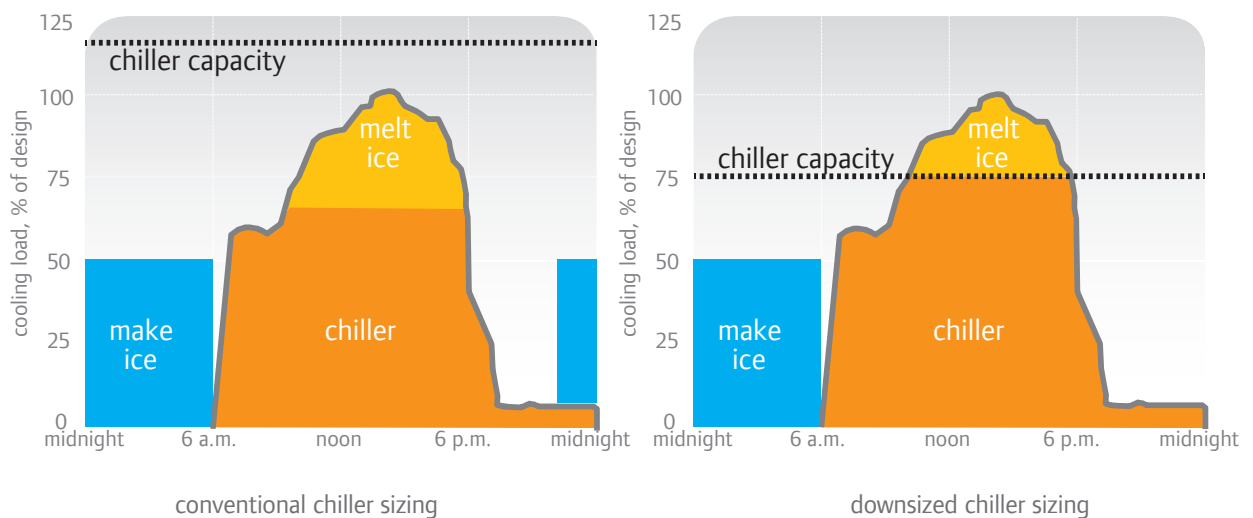

Adding ice to a chilled-water system

Ice plant as a system component

While existing air-cooled chillers can often be retrofit for making ice, other types of chilled-water systems can benefit by adding a self-contained ice plant to the system. Below is an example of a Trane® ice-enhanced air-cooled chiller plant installed upstream of one of two existing centrifugal chillers, separated by a heat exchanger to isolate glycol. If the flows are suitable, the new plant could be upstream of both existing chillers.

Benefits of adding ice to an existing chilled-water system include redundancy for one or more chillers, expansion of the system, maximum reuse of existing components and better system efficiency. Existing chillers do not need retrofitting and can handle cooling loads while the new ice chiller charges the tanks.

Consider the location of the heat exchanger to balance with ice plant flow rates and capacity. Locating the heat exchanger upstream of existing chiller(s) provides easier load-shifting and ice-priority control, while a downstream ice plant location improves chiller efficiency.

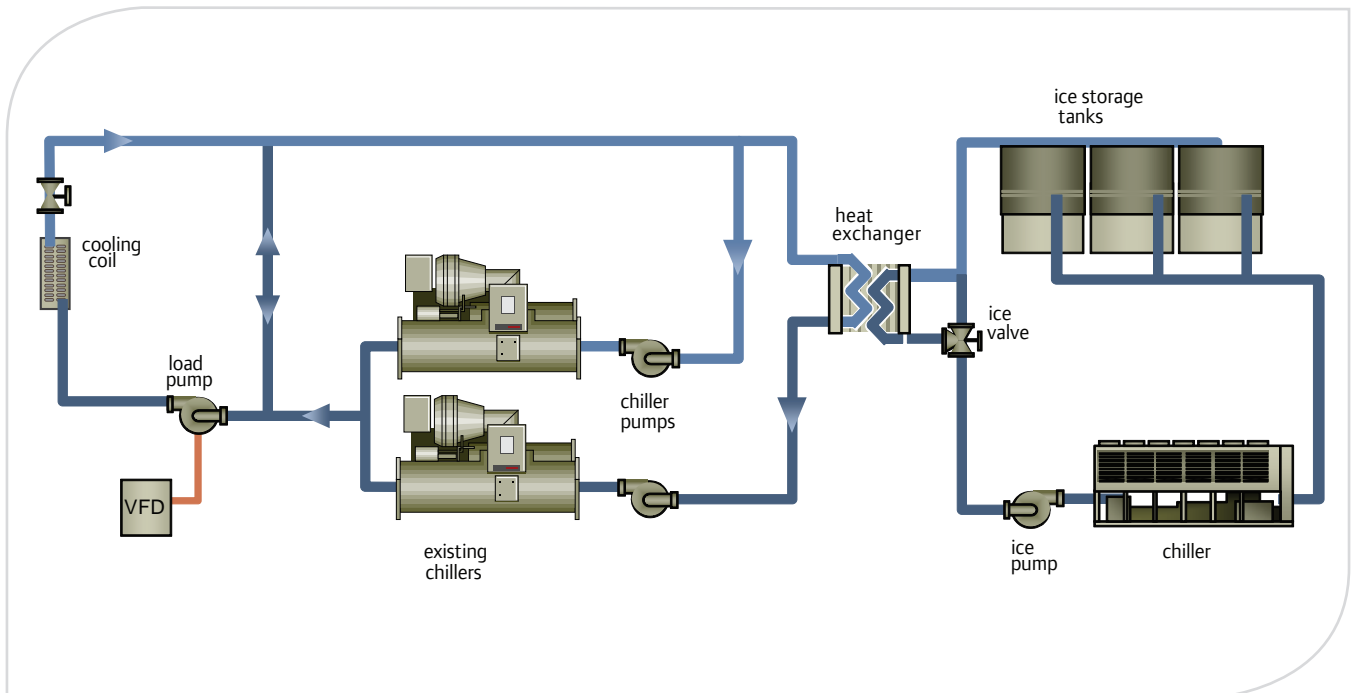

Standard configurations



Variable flow cooling, constant flow charging

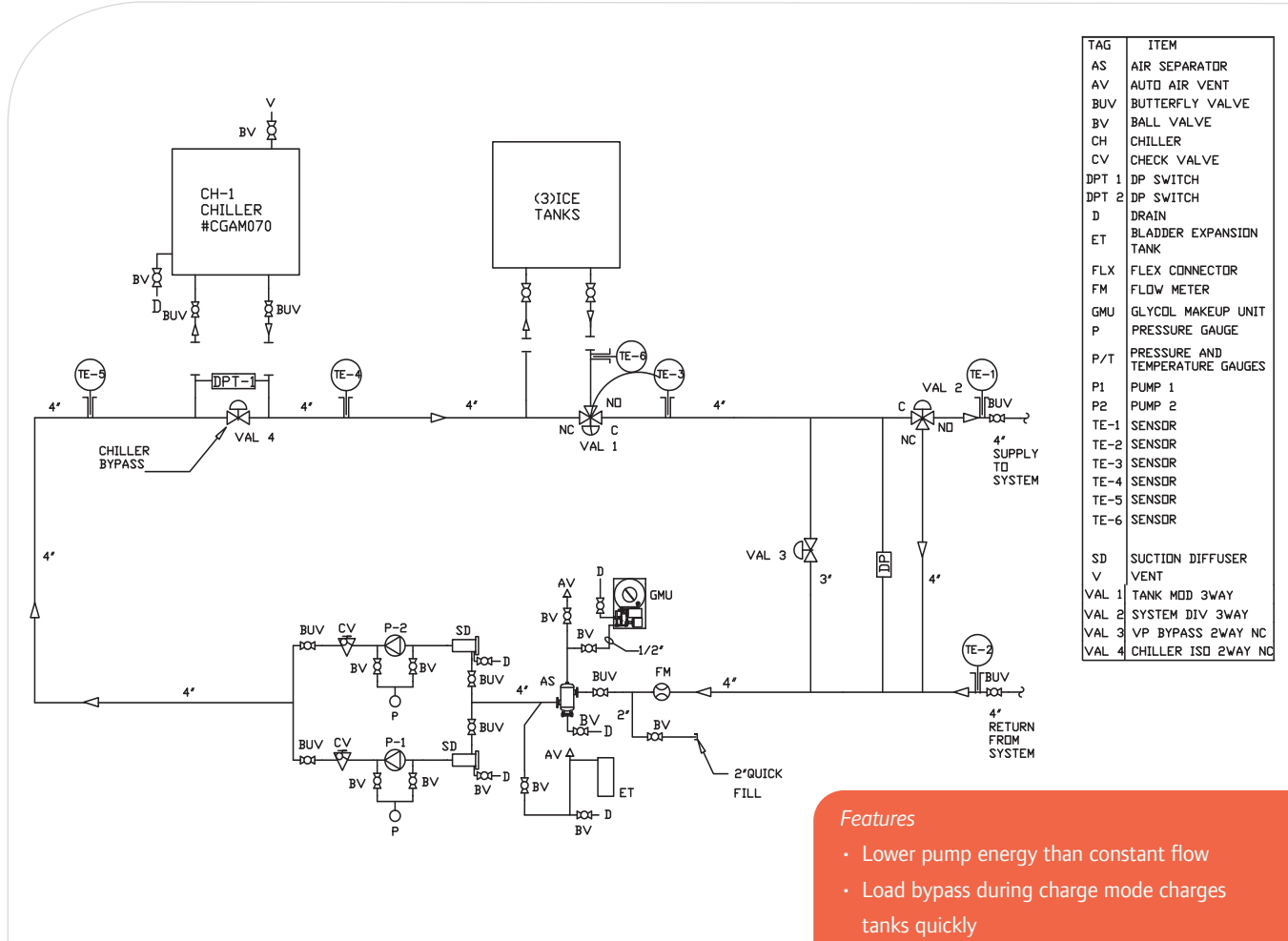

TAG	ITEM
AS	AIR SEPARATOR
AV	AUTO AIR VENT
BUV	BUTTERFLY VALVE
BV	BALL VALVE
CH	CHILLER
CV	CHECK VALVE
DPT 1	DP SWITCH
DPT 2	DP SWITCH
D	DRAIN
ET	BLADDER EXPANSION TANK
FLX	FLEX CONNECTOR
FM	FLOW METER
GMU	GLYCOL MAKEUP UNIT
P	PRESSURE GAUGE
P/T	PRESSURE AND TEMPERATURE GAUGES
P1	PUMP 1
P2	PUMP 2
TE-1	SENSOR
TE-2	SENSOR
TE-3	SENSOR
TE-4	SENSOR
TE-5	SENSOR
TE-6	SENSOR
SD	SUCTION DIFFUSER
V	VENT
VAL 1	TANK MOD 3WAY
VAL 2	SYSTEM DIV 3WAY
VAL 3	VP BYPASS 2WAY NC
VAL 4	CHILLER ISD 2WAY NC

Features

- Lower pump energy than constant flow
- Load bypass during charge mode charges tanks quickly
- Variable Frequency Drive (VFD) eliminates need for triple duty valve for system balancing
- VFD communicates with system controller for power management and reporting

Considerations

- Cost of VFD on pump
- Building load during charge cycle should be kept to a minimum either by:
 - ignoring calls for cooling, or
 - installing a separate cooling system for critical spaces, or
 - delaying charge until after loads diminish, reducing the amount of time available for charging tanks.

Decoupled with heat exchanger

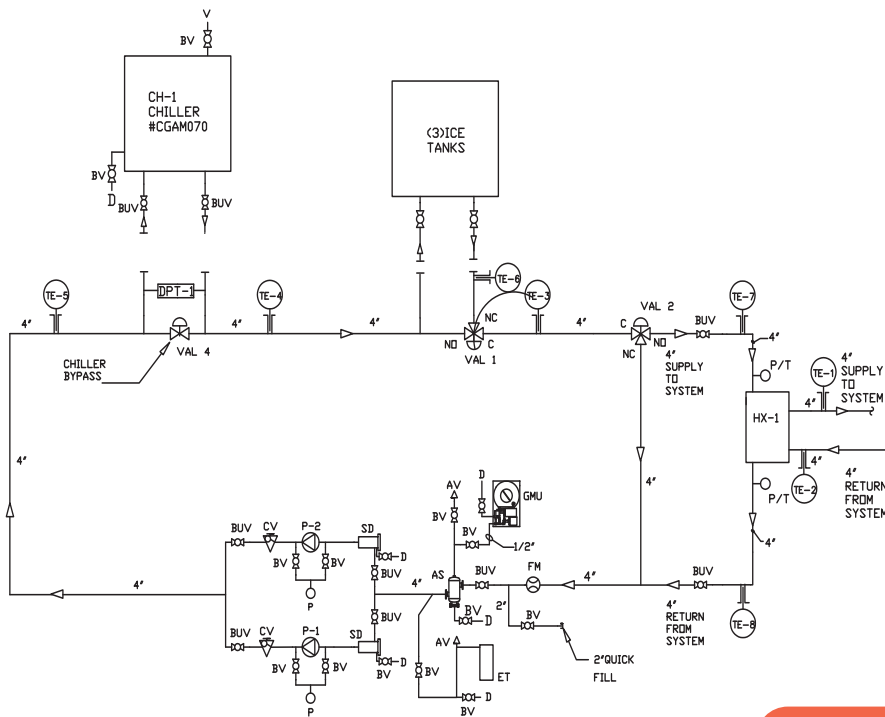

TAG	ITEM
AS	AIR SEPARATOR
AV	AUTO AIR VENT
BUV	BUTTERFLY VALVE
BV	BALL VALVE
CH	CHILLER
CV	CHECK VALVE
DPT 1	DP SWITCH
D	DRAIN
ET	BLADDER EXPANSION TANK
FLX	FLEX CONNECTOR
FM	FLOW METER
GMU	GLYCOL MAKEUP UNIT
P	PRESSURE GAUGE
P/T	PRESSURE AND TEMPERATURE GAUGES
P1	PUMP 1
P2	PUMP 2
TE-1	SENSOR
TE-2	SENSOR
TE-3	SENSOR
TE-4	SENSOR
TE-5	SENSOR
TE-6	SENSOR
TE-7	SENSOR
TE-8	SENSOR
SD	SUCTION DIFFUSER
V	VENT
VAL 1	TANK MOD 3WAY
VAL 2	SYSTEM DIV 3WAY
VAL 3	N/A
VAL 4	CHILLER ISO 2WAY NC
HX	HEAT EXCHANGER

Features

- Easier to plug into an existing decoupled system, possibly with an existing air-cooled chiller, reuse distribution pump
- Cost of glycol is lower with the shorter glycol loop, a consideration as systems get larger
- Water in the coils rather than glycol

Considerations

- Cost of heat exchanger
- Cooling during charge mode is more complicated and therefore not supported by this phase of prepackaged system controls
- Care must be taken to avoid freezing water on the load side of the heat exchanger – a tempering loop may be preferred

Supports the way you work



The beauty of a prepackaged Trane System is that it efficiently passes knowledge and expertise to the people who make it happen. While this makes us choose specific, detailed configurations, it also allows for an advanced starting point—reducing the risk and confusion of doing something for the first time.

Trane and CALMAC give you tools for calculating system payback, optimizing control algorithms, modeling system performance, and provide BIM drawings to support efficient design practices.

For the Engineer

Making it all happen without blowing the budget is critical. Trane® and CALMAC® worked together to create system drawings and control sequences to help you—whether you select one of our packaged systems, or make a custom design of your own.

For selecting the right size system, CALMAC IcePick™ software takes you from a design day load profile to the smallest chiller, or other combinations of ice and chiller to meet the design day load with capacity to spare. Another software tool, FirstPass™ from Trane, helps determine the final charge temperature based on the chiller, the flow rate, and the number of tanks. This tool can be used to determine:

- if the chiller and tanks operate within their flow constraints during the charging mode,
- the final charge temperature for a full charge based on the flow rate, chiller and tanks,
- the max discharge tons and stored ton-hours, and
- if the tanks can be charged in the amount of time available.

(Data on p. 24 provides information for the chiller performance entries for IcePick.)

Once you have IcePick results, the chiller selection software will provide performance at the average charge temperature and allow you to test stability, performance, and percent glycol required for the selected chiller at the final charge temperature.

CALMAC® IcePick™ design day chiller and tank sizing

With the design day load profile, this software finds combinations of chiller and tanks.

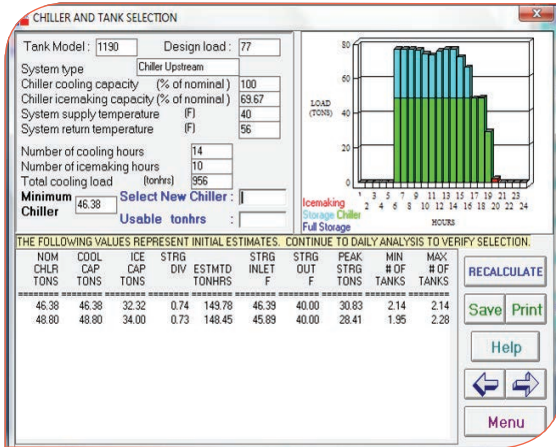

Schematics with bills of material

Layouts of four sizes of completion skids, with and without the optional heat exchanger, are available.

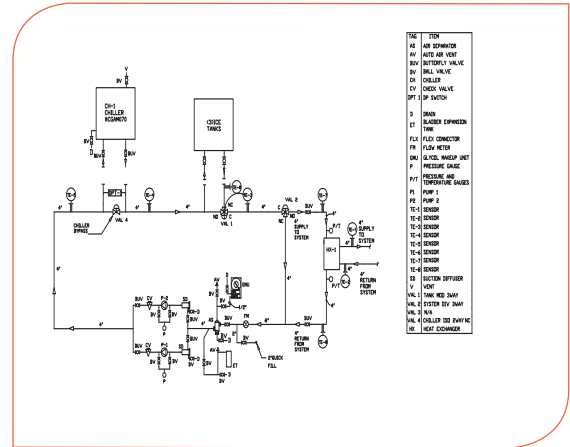

Chiller selection software

Trane® official product selection software (Trane Select Assist) provides detailed capacity and flow information.

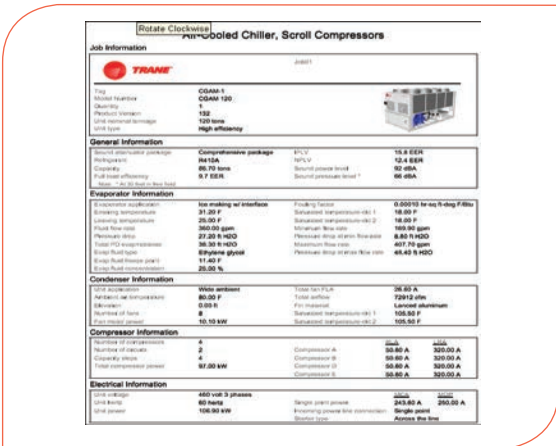

BIM drawing files

Chillers, tanks and system completion skids available in .dwg and Revit formats.



FirstPass™ from Trane

Focuses on balancing flows between chiller(s) and tanks, final temperature, and time to charge.

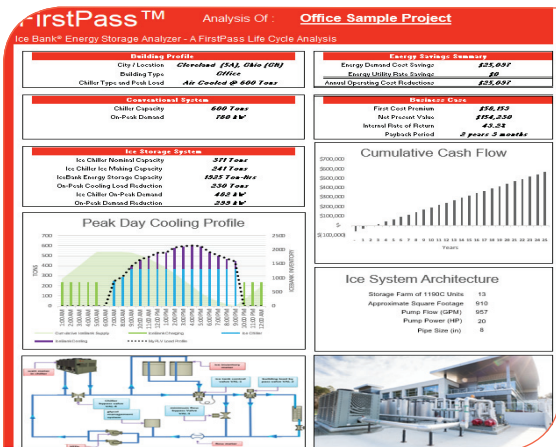

TRACE® modeling software and support

TRACE energy analysis software can take your load design entries and do what-if scenarios for several options.

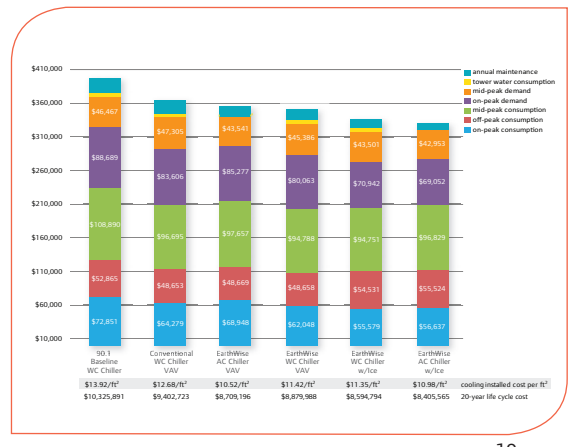

For the System Installer

System installers can either stick-build the system using our suggested systems, or purchase a system completion skid from Trane® Creative Solutions. With the system completion skid, system installers can take advantage of a prepackaged system—reducing the risk and confusion of doing something for the first time. Simpler selection, submittals, and ordering processes save time and reduce errors. Prepiped pumping and accessories on a factory-built and -commissioned completion skid reduce startup time on the job.

In addition, CALMAC® Ice Bank® tanks are available with tank connection piping already completed. You have the option of two or three packs with same end connections or opposite end connections for reverse return piping (recommended) arrangements.

System completion skids

Pre-engineered pump modules also include ancillary equipment such as valves, sensors, expansion tanks and a glycol management system.



Ice Bank packages

For systems with multiple tanks, installation is quicker with a crane and combinations of two or three tanks installed as one group.



For the Building Operator

An operator selects the expected daily load profile based on the day type and weather forecast to determine how the plant will operate.

More advanced information about the system and how it is operating can be accessed from other interface screens. Scheduling modes of operation is accomplished by a simple-to-use interface accessed through the dashboard.

The dashboard on the right can include a link from the chiller and ice plant screen to the air handlers. Air handler at-a-glance information can be mapped to this screen, if desired.

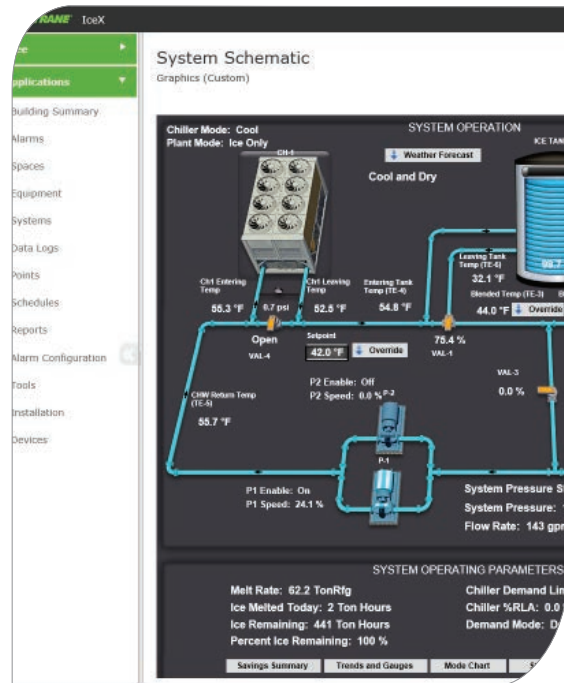

Configuration screen

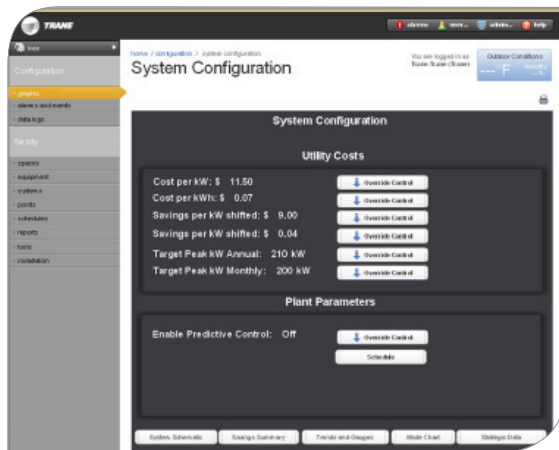

At-a-glance gauges



Scheduling application

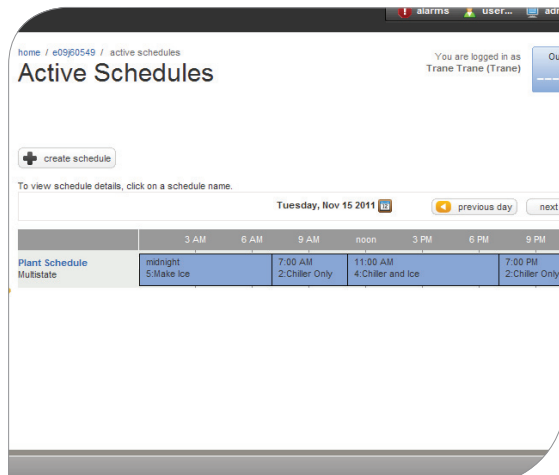

Scheduled versus actual mode

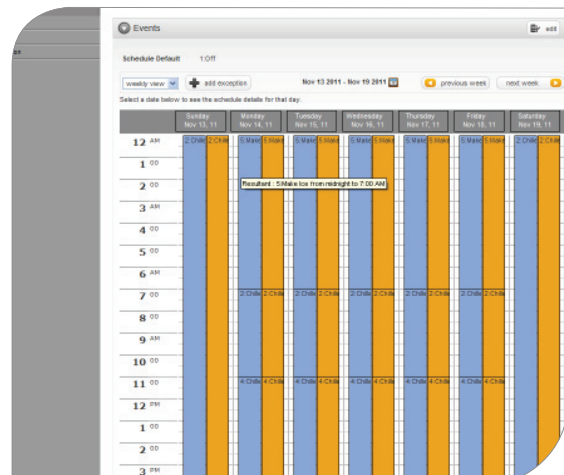

For the Owner

Preprogrammed displays demonstrate how the system saves money when operating and provides opportunities to further optimize system operation.

You want to know that your system is saving money as predicted. One of the common “complaints” about this system is that it saves more money than predicted.

Performance summary

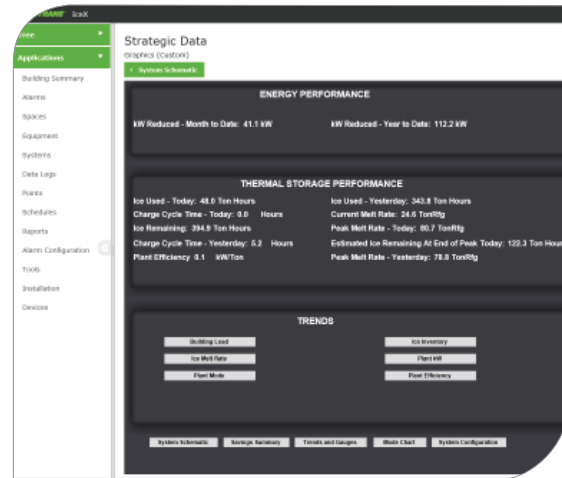

For the Occupants

A lobby or entrance hall is an optimal place to display the great work your facility is doing to reduce energy costs. Students, employees or customers can see the benefits and learn about the system you’ve installed.

Graphics illustrate the system operation and performance at a moment in time. The economic dashboard estimates system savings.

Savings calculations



System Components



RTAF



ACS



CGAM



RTAC



ACR

Air-cooled Chillers

Chiller performance data

	operating conditions								chiller flow and pressure drop						combined capacity and efficiency				
	evap. 23/30°F 80°F ent. air		evap. 40/54°F 95°F ent. air		evap 42/56°F 95°F ent. air		evap 48/56°F 95°F ent. air		min flow	PD@min flow	flow @3x nom. tons	PD@3x nom. ton flow	max flow	PD@ max flow	48-38°F		56-48°F	melt mode at 95°F ambient	
	tons	kW	tons	kW	tons	kW	tons	kW	gpm	ft of H ₂ O	gpm	ft of H ₂ O	gpm	ft of H ₂ O	tanks	melt tons	chiller tons	kW/ ton	Full load design day EER
CGAM020	14.1	18.2	18.3	22.5	19.0	22.7	20.6	23.2	23.2	4.0	60	24.6	69.7	32.7	1	22	20.6	0.519	23.1
CGAM026	18.5	23.6	23.4	29.6	24.2	29.9	26.2	30.6	29.8	3.9	78	24.5	89.4	32.0	2	44	26.2	0.412	29.1
CGAM030	20.6	26.3	26.5	32.1	27.4	32.4	29.7	33.1	33.4	4.8	90	32.1	100.3	40.2	2	44	29.7	0.426	28.2
CGAM035	24.1	31.3	30.9	39.2	31.9	39.5	34.6	40.3	39.2	4.1	105	26.7	117.7	33.3	2	44	34.6	0.488	24.6
CGAM040	26.4	36.0	35.2	44.8	36.6	45.3	40.1	46.4	45.4	5.7	120	37.4	136.1	47.7	2	44	40.1	0.526	22.8
CGAM052	36.4	47.1	46.2	59.4	47.7	60.0	51.9	61.5	58.8	5.1	156	32.5	176.4	41.1	3	66	51.9	0.496	24.2
CGAM060	41.4	53.6	53.4	65.7	55.3	66.3	60.3	67.9	67.1	5.0	180	33.3	201.4	41.2	3	66	60.3	0.513	23.4
CGAM070	49.4	63.2	63.1	79.3	65.3	80.0	71.1	81.9	79.5	4.9	210	31.8	238.6	40.6	4	88	71.1	0.490	24.5
CGAM080	56.4	70.3	72.8	88.3	75.3	89.1	82.0	91.0	91.8	4.8	240	29.6	275.3	38.5	4	88	82.0	0.511	23.5
CGAM090	63.7	80.6	81.5	101.2	84.3	102.1	91.6	104.4	102.6	4.3	270	27.2	307.8	35.1	5	110	91.6	0.493	24.3
CGAM100	71.3	91.2	92.1	112.6	95.4	113.5	103.8	115.8	115.5	4.7	300	29.3	346.6	38.8	5	110	103.8	0.517	23.2
CGAM110	77.9	101.3	99.8	125.7	103.3	126.8	112.3	129.6	125.2	4.8	330	31.4	375.7	40.5	6	132	112.3	0.505	23.7
CGAM120	84.9	111.3	108.0	138.7	117.7	139.9	121.3	143.2	135.9	5.6	360	37.2	407.7	47.5	6	132	121.3	0.540	22.2
CGAM130	91.5	115.5	117.4	144.2	121.5	145.5	132.1	148.6	146.9	5.5	390	39.7	440.8	50.4	7	154	132.1	0.495	24.2
ACS140	94.9	122.6	124.8	152.0	129.6	153.6	141.0	157.3	168.0	3.3	420	17.0	504.0	23.6	7	154	141.0	0.509	23.6
ACS160	104.7	140.3	136.4	174.3	141.7	176.2	154.2	180.6	192.0	4.1	480	21.6	576.0	30.0	7	154	154.2	0.561	21.4
ACS180	119.0	159.1	160.2	200.4	166.2	202.7	181.8	208.6	216.0	5.1	540	26.6	648.0	37.1	8	176	181.8	0.558	21.5
ACS200	127.1	174.6	170.8	219.7	177.1	222.1	193.7	228.4	240.0	6.1	600	32.2	720.0	45.0	9	198	193.7	0.557	21.5
ACS215	141.0	190.0	183.4	234.6	190.5	236.8	208.6	242.7	258.0	7.0	645	36.7	774.0	51.3	10	220	208.6	0.541	22.2
ACS230	152.2	208.0	197.4	257.4	205.0	260.0	224.0	266.4	276.0	5.5	690	29.1	828.0	40.6	11	242	224.0	0.546	22.0
ACR150	98.4	110.0	127.8	142.0	134.5	144.6	155.0	152.5	171.0	3.0	450	24.4	626.0	46.8	7	154	155.0	0.472	25.4
ACR165	110.2	121.9	143.5	156.6	151.0	159.4	174.2	168.1	187.0	3.0	495	25.0	684.0	47.4	8	176	174.2	0.459	26.1
ACR180	119.0	134.1	154.8	172.1	162.9	175.2	187.8	184.8	202.0	2.9	540	24.4	742.0	45.8	8	176	187.8	0.487	24.7
ACR200	132.4	148.4	172.2	189.0	181.2	192.4	209.4	203.1	228.0	2.9	600	24.1	835.0	46.4	9	198	209.4	0.478	25.1
ACR225	156.0	168.8	201.2	219.5	211.3	223.2	242.1	234.6	261.0	3.0	675	23.7	957.0	47.2	11	242	242.1	0.464	25.9
ACR250	168.2	188.1	216.6	244.2	227.3	248.4	260.4	261.9	288.0	3.1	750	24.4	1055.0	47.9	12	264	260.4	0.477	25.1
ACR275	182.1	203.0	235.3	262.5	247.7	267.2	285.3	281.5	318.0	2.9	825	22.9	1165.0	45.4	13	286	285.3	0.471	25.5
ACR300	201.8	227.2	261.4	292.9	275.2	298.2	317.9	314.4	354.0	2.9	900	22.2	1299.0	45.9	14	308	317.9	0.481	25.0

all chiller and tank performance based on 25% ethylene glycol

Chiller performance data, continued

	operating conditions								chiller flow and pressure drop						combined capacity and efficiency				
	evap. 23/30°F 80°F ent. air		evap. 40/54 °F 95°F ent. air		evap 42/56 °F 95°F ent. air		evap 48/56 °F 95°F ent. air		min flow	PD@ min flow	flow @3x nom. tons	PD@3x nom. ton flow	max flow	PD@ max flow	48-38 °F		56-48 °F	melt mode at 95°F ambient	
	tons	kW	tons	kW	tons	kW	tons	kW	gpm	ft of H ₂ O	gpm	ft of H ₂ O	gpm	ft of H ₂ O	tanks	melt tons	chiller tons	kW/ton	Full load design day EER
RTAC140S	100.0	125.0	125.9	162.7	131.6	166.2	149.2	177.3	193.0	3.6	420	18.5	709.0	49.5	7	154	149.2	0.559	21.5
RTAC140H	101.0	120.6	128.5	154.5	134.5	157.6	153.3	167.5	202.0	3.0	420	14.4	741.0	41.6	7	154	153.3	0.521	23.0
RTAC155S	110.0	136.2	138.5	177.3	144.6	181.0	163.1	192.4	193.0	3.6	465	22.5	709.0	49.5	8	176	163.1	0.542	22.1
RTAC155H	112.5	132.4	142.8	169.9	149.3	173.2	169.2	183.5	202.0	3.0	465	17.6	741.0	41.6	8	176	169.2	0.508	23.6
RTAC170S	121.4	148.0	152.8	192.8	159.3	196.7	178.8	208.7	202.0	3.0	510	20.9	741.0	41.6	9	198	178.8	0.529	22.7
RTAC170H	122.7	142.8	155.8	183.5	162.7	187.0	183.9	197.9	217.0	3.1	510	18.4	796.0	41.9	9	198	183.9	0.495	24.2
RTAC185S	133.2	163.4	167.6	213.5	174.5	217.8	194.9	231.0	202.0	3.1	555	24.5	741.0	41.5	9	198	194.9	0.562	21.3
RTAC185H	136.2	158.7	173.6	205.0	180.9	209.0	202.8	221.2	217.0	3.3	555	23.4	796.0	45.4	10	220	202.8	0.499	24.0
RTAC200S	145.6	179.2	183.4	234.9	190.8	239.8	212.4	254.4	217.0	3.1	600	25.0	796.0	41.9	10	220	212.4	0.562	21.3
RTAC200H	148.8	174.3	190.3	226.2	198.1	230.7	220.7	243.9	217.0	3.3	600	27.1	796.0	45.4	10	220	220.7	0.529	22.7
RTAC225S	161.5	197.6	203.9	260.0	211.9	265.4	235.1	281.4	217.0	3.4	675	33.6	796.0	45.3	11	242	235.1	0.564	21.3
RTAC225H	161.4	189.3	206.4	247.1	214.8	252.1	238.9	266.8	217.0	3.4	675	33.6	796.0	45.3	11	242	238.9	0.531	22.6
RTAC250S	176.4	215.5	223.3	284.5	231.9	290.4	256.3	307.7	217.0	3.4	750	40.7	796.0	45.3	12	264	256.3	0.565	21.2
RTAC250H	178.6	207.8	228.7	271.6	237.8	277.0	263.7	292.9	217.0	3.4	750	40.6	796.0	45.3	12	264	263.7	0.531	22.6
RTAC275S	194.7	238.9	246.5	312.9	256.3	319.1	284.4	337.2	265.0	3.2	825	32.5	970.0	43.5	13	286	284.4	0.565	21.2
RTAC275H	197.7	227.2	252.4	294.0	263.4	299.9	296.0	317.8	339.0	3.3	825	20.9	1243.0	44.4	14	308	296.0	0.503	23.9
RTAC300S	219.7	271.5	278.0	356.9	288.9	364.3	320.1	385.8	309.0	3.3	900	28.9	1134.0	44.0	15	330	320.1	0.567	21.2
RTAC300H	222.9	261.5	285.4	340.3	297.3	347.3	331.5	367.7	339.0	3.3	900	24.6	1374.0	44.4	15	330	331.5	0.532	22.6
RTAC350S	250.0	308.5	316.6	407.2	329.0	415.9	363.7	441.0	339.0	3.3	1050	32.7	1243.0	44.3	17	374	363.7	0.571	21.0
RTAC350H	252.5	284.6	321.1	367.1	334.5	374.0	374.3	394.7	381.0	3.4	1050	27.0	1396.0	45.5	17	374	374.3	0.504	23.8
RTAC400S	298.8	366.0	376.0	481.0	390.4	490.8	431.9	519.7	381.0	3.4	1200	34.5	1396.0	45.4	20	440	431.9	0.570	21.1
RTAC400H	303.6	355.9	386.6	462.1	402.1	471.4	447.6	498.7	422.0	3.4	1200	28.9	1548.0	46.0	21	462	447.6	0.524	22.9
RTAC450S	329.7	395.5	415.6	521.6	431.4	532.5	475.9	564.1	404.0	3.4	1350	38.5	1483.0	45.7	22	484	475.9	0.562	21.4
RTAC500H	360.3	427.8	454.0	565.2	471.0	577.1	519.8	612.3	422.0	3.4	1500	43.3	1548.0	45.9	25	550	519.8	0.547	21.9
RTAF115	74.7	91.6	97.1	116.4	101.3	118.4	114.7	125.4	128.0	6.3	345	44.7	470.0	83.9	5	110	114.7	0.534	22.5
RTAF130	86.5	104.5	111.4	133.1	116.1	135.6	131.4	144.1	150.0	6.4	390	42.3	551.0	85.4	6	132	131.4	0.523	22.9
RTAF150	100.6	121.3	131.1	153.6	136.7	156.2	154.9	165.1	171.0	6.2	450	42.1	626.0	82.5	7	154	154.9	0.511	23.5
RTAF170	111.1	131.8	143.2	168.5	149.2	171.7	168.9	182.4	187.0	6.3	510	45.7	684.0	83.1	8	176	168.9	0.505	23.7
RTAF180	121.9	142.5	155.8	184.1	162.3	187.8	183.3	200.1	199.0	6.3	540	45.2	731.0	83.7	9	198	183.3	0.501	24.0
RTAF200	133.4	163.4	172.6	206.3	179.9	209.9	203.6	222.3	202.0	6.1	600	52.8	742.0	81.5	9	198	203.6	0.530	22.7
RTAF215	144.5	179.8	187.1	228.5	195.0	232.8	220.5	247.1	228.0	6.2	645	48.5	835.0	82.1	10	220	220.5	0.537	22.4
RTAF230	153.3	180.7	196.9	231.8	205.0	236.3	231.6	251.7	261.0	6.2	690	42.6	957.0	82.9	11	242	231.6	0.508	23.6
RTAF250	166.5	197.4	212.9	255.8	221.6	261.1	249.9	278.9	288.0	6.3	750	41.8	1055.0	83.6	12	264	249.9	0.519	23.1
RTAF270	181.1	225.9	229.3	294.6	238.4	300.9	267.9	322.0	288.0	5.8	810	45.1	1055.0	77.3	13	286	267.9	0.555	21.6
RTAF280	190.1	227.0	246.5	291.1	256.7	296.6	288.1	313.5	304.0	5.2	840	39.0	1113.0	69.3	13	286	288.1	0.522	23.0
RTAF310	210.9	246.3	273.8	315.0	285.0	320.8	318.7	339.2	323.0	5.2	930	42.5	1183.0	69.5	15	330	318.7	0.500	24.0
RTAF350	236.7	279.9	305.0	363.0	317.2	370.4	354.1	393.6	367.0	5.2	1050	42.0	1345.0	69.7	16	352	354.1	0.533	22.5
RTAF390	269.5	338.3	341.7	444.5	355.0	454.1	393.7	484.1	367.0	5.0	1170	50.2	1345.0	66.8	18	396	393.7	0.586	20.5
RTAF410	281.5	328.9	364.0	426.2	378.7	434.6	422.7	460.5	446.0	5.3	1230	39.7	1635.0	70.9	19	418	422.7	0.524	22.9
RTAF450	309.3	361.2	401.5	465.1	417.9	474.1	466.6	501.5	487.0	5.3	1350	40.3	1786.0	71.3	21	462	466.6	0.517	23.2
RTAF500	334.4	395.0	431.4	513.5	448.8	523.9	500.0	555.6	506.0	5.4	1500	46.2	1855.0	71.4	23	506	500.0	0.528	22.7
RTAF520	351.0	427.7	450.2	558.2	468.0	569.9	520.4	605.0	506.0	5.1	1560	48.0	1855.0	68.5	24	528	520.4	0.552	21.7

all chiller and tank performance based on 25% ethylene glycol

CALMAC® Ice Bank®

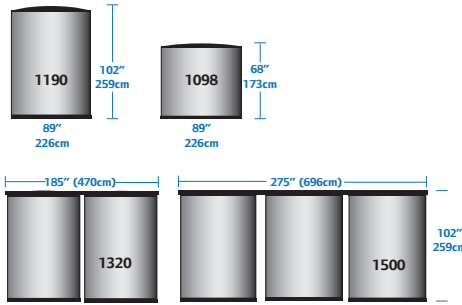

Specifications

Dimensions (L x W x H)	89" x 91" x 102"
Filled weight	16,900 lbs
Floor loading	391 lb/sq. ft.
Inlet/outlet flange connection size	4"
Manufacturer product line	Ice Bank®
Maximum operating pressure	90 psi
Maximum operating temperature	100°F
Net usable capacity*	162 ton/hr
Shipping weight	2000 lb
Volume of water ice	1655 gal
Volume of solution in heat exchanger	157 gal

*Typical value, varies with conditions

Pressure drop curves

Based on 25% ethylene glycol. Contact Trane® or CALMAC representative for other fluids or concentrations.

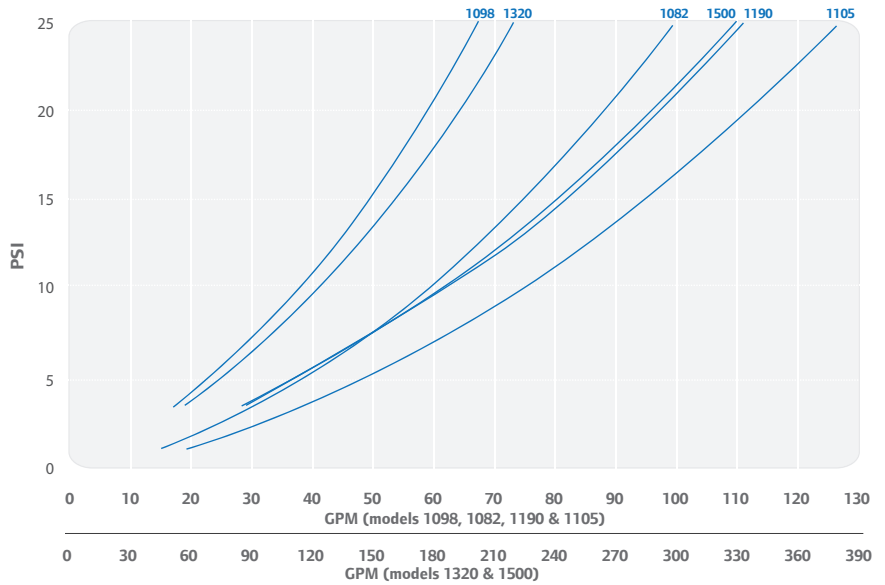

CALMAC Ice Bank tank weights and dimensions

Model	Nominal (net usable) ton-hrs*	Flange size (in.)	Shipping weight (lb)	Filled weight (lb)	Floor loading (lb/ft ²)	Width (in.)	Length (in.)	Height (in.)
1500C	486	4	6000	50600	391	89	273	102
1320C	324	4	4000	34000	391	89	181	102
1190	162	4	2000	16900	391	89	92	102
1105	105	4	1315	10885	360	73 ¾	76 ½	102
1098	98	4	1275	10235	237	89	92	69 ½
1082	82	4	1065	8580	283	73 ¾	76 ½	84 ½
1045	41	2	580	4380	150	73 ¾	76 ½	48

*Typical value, varies with conditions

Maximum operating pressure for all tanks is 90 psi
 Dimensions can change, contact CALMAC for up-to-date specifications
 Dimensions reflect the larger of same side or reverse side connections
 Models 1190, 1098, 1105 and 1082 tanks can be ordered with two, three, or four flanges with headers underneath the lid.
 Models 1320 and 1500 are pre-piped packages of two and three 1190 tanks, respectively, and require a crane for rigging. All other models can be installed by forklift.
 A-style tanks have a 2-inch flanged connection with forklift bases. These are used for the small project, replacement market. A 2-inch flange simplifies installation.
 C-style tanks have a 4-inch flanged connection without a forklift base. The C-style tanks have the option to be manufactured with two, three or four flanges.
 This option works because under the lid is a connecting header.

Ice Bank® Performance in Charge Mode (Model 1190)

The table below shows the capacity that can be absorbed by the tank at various average charging temperatures. Both CALMAC® IcePick™ and Trane® FirstPass™ software incorporate this information into the calculations. The table below illustrates the balance that must be struck between chiller and tank sizing.

Minimum charging brine temperature to Ice Bank for full charge (°F)

Average charging temperature (°F)	tons/tank						
	5	10	15	20	25	30	35
28	25.7	25.1					
27	24.7	24.3	23.8				
26		23.4	22.9				
25		22.7	22.1	21.4			
24		22.1	21.4	20.7			
23			20.8	20.1	19.3		
22			20.1	19.5	18.6		
21			19.5	18.9	18.1	17.6	
20				18.3	17.7	17.2	
19					17.3	16.7	
18						16.1	15.8

Charging rate by flow rate

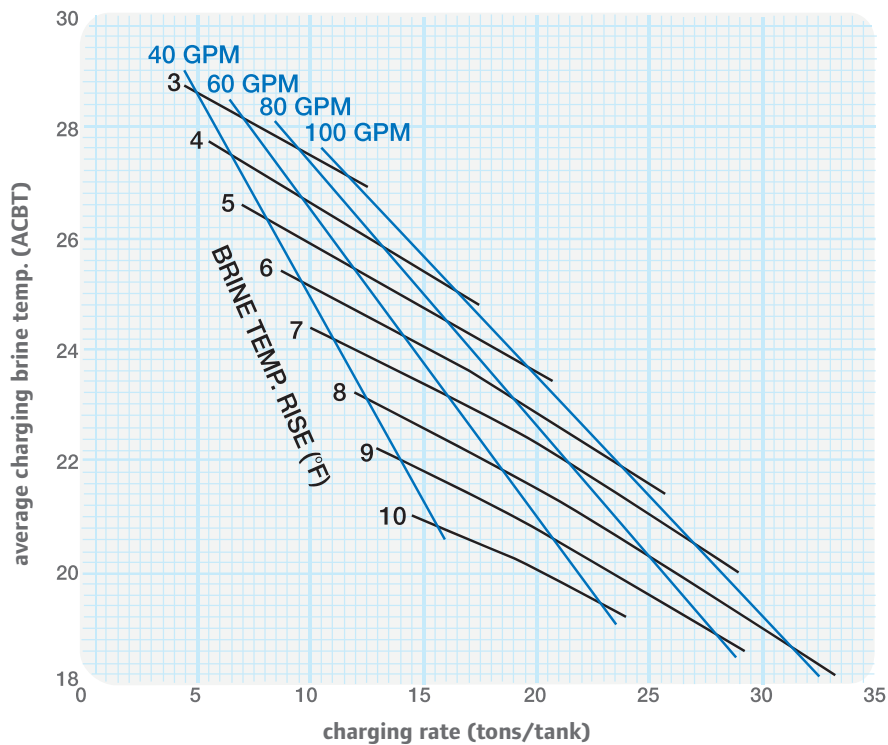

Ice Bank® Performance in Discharge Mode (Model 1190)

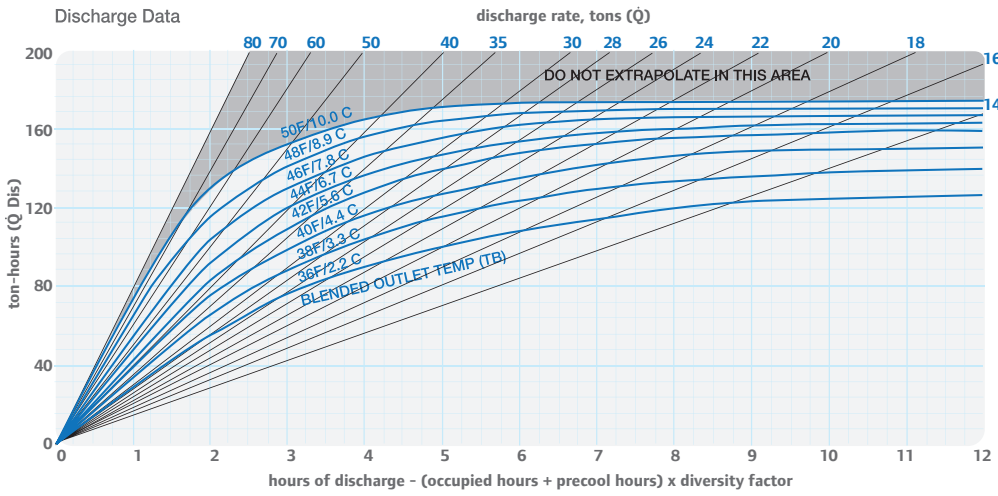

storage inlet temperature (Tin)

60°F

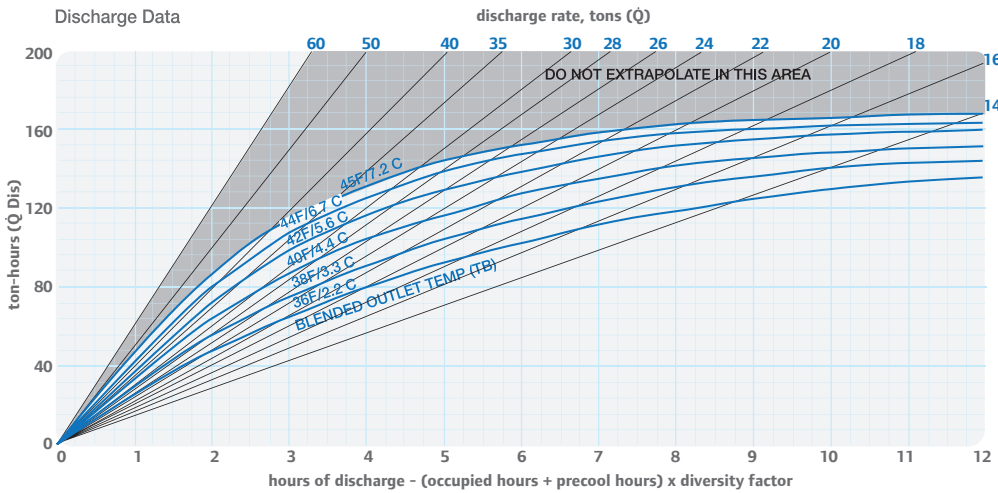

storage inlet temperature (Tin)

50°F

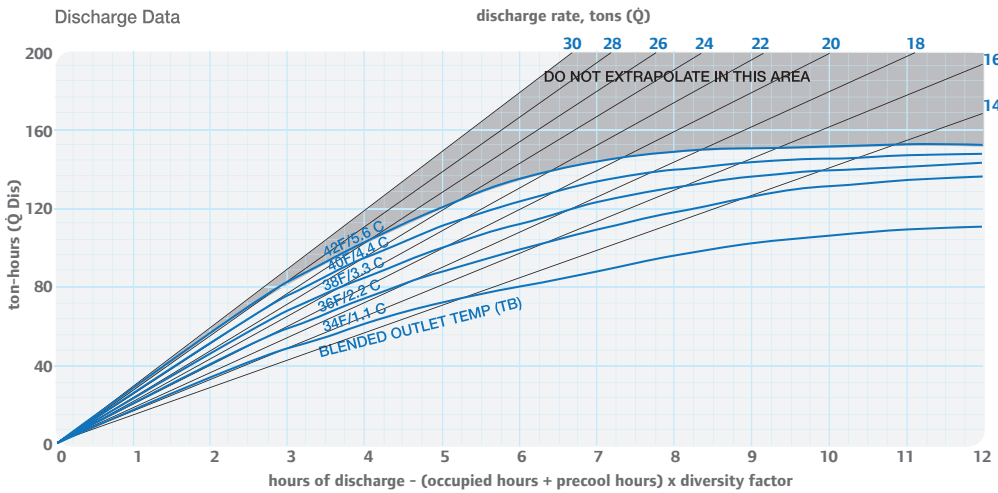

storage inlet temperature (Tin)

45°F

Controls

Thermal Battery™ Air-cooled Chiller Plant Systems include an optional system completion module, preprogrammed control sequences, operator graphics, reports, drawings and guide specifications.

BACnet™ communicating system controller (Tracer® SC) and sub-system controller (UC600)

Preprogrammed sequences

- One chiller, no heat exchanger
- Two chillers, no heat exchanger
- One chiller with heat exchanger and two distribution pumps
- Two chillers with heat exchanger and two distribution pumps

Control functions

- System scheduling
- Six modes of operation
 - Off
 - Chiller only - single and multiple chiller
 - Ice only
 - Chiller and ice
 - Make ice
 - Make ice and cool
- System mode determination
- Chiller plant demand limiting
- Ice inventory management
- Chilled fluid system control
- Chiller/ice sequencing and control
- Color graphic based chiller and plant status screens
- System and chiller diagnostic messages
- System and chiller reporting
- Failure modes and recovery
- Heat exchanger sequencing and control (option)
- Pump control for water loops (option)



Information displayed at sub-system controller and at system controller

- Ton hours used last ice discharge cycle
- Ton hours stored last ice build cycle
- Peak kW
- Estimated savings



System Completion Module

Electrical data

skid type	pumps running	pump impeller size	HP	pump FLA			controls (amps)			208V			460V			575V		
				208V	460V	575V	208V	460V	575V	skid MCA	RDE	skid MOP	skid MCA	RDE	skid MOP	skid MCA	RDE	skid MOP
No HEX, 1 Chiller	1	1.5x1x8	15	42	19	17.2	6.94	3.14	2.5	59.4	70	100	26.9	35	45	24.0	30	40
1 HEX, 1 Chiller	1	1.5x1x6	7.5	22	9.9	8.6	6.94	3.14	2.5	34.3	40	50	15.5	20	25	13.3	20	25
No HEX, 2 Chiller	2	1.5x1x8	15	42	19	17.2	6.94	3.14	2.5	101.4	125	125	45.9	60	60	41.2	50	50
1 HEX, 2 Chiller	2	1.5x1x6	7.5	22	9.9	8.6	6.94	3.14	2.5	56.4	70	70	25.4	30	35	21.9	25	30
No HEX, 1 Chiller	1	3x1.5x8	20	54	25	20.9	6.94	3.14	2.5	74.4	90	125	34.4	45	50	28.6	35	45
1 HEX, 1 Chiller	1	3x2x13	15	42	19	17.2	6.94	3.14	2.5	59.4	70	100	26.9	35	45	24.0	30	40
No HEX, 2 Chiller	2	3x1.5x8	20	54	25	20.9	6.94	3.14	2.5	128.4	150	175	59.4	70	80	49.5	60	70
1 HEX, 2 Chiller	2	3x2x13	15	42	19	17.2	6.94	3.14	2.5	101.4	125	125	45.9	60	60	41.2	50	50
No HEX, 1 Chiller	1	3x2.5x8	30	80	36	32.7	6.94	3.14	2.5	106.94	150	175	48.1	60	80	43.4	60	70
1 HEX, 1 Chiller	1	4x3x11.5	20	54	25	20.9	6.94	3.14	2.5	74.4	90	125	34.4	45	50	28.6	35	45
No HEX, 2 Chiller	2	3x2.5x8	30	80	36	32.7	6.94	3.14	2.5	186.9	225	250	84.1	100	110	76.1	90	100
1 HEX, 2 Chiller	2	4x3x11.5	20	54	25	20.9	6.94	3.14	2.5	128.4	150	175	59.4	70	80	49.5	60	70
No HEX, 1 Chiller	1	4x3x8	30	80	36	32.7	6.94	3.14	2.5	106.94	150	175	48.1	60	80	43.4	60	70
1 HEX, 1 Chiller	1	4x3x11.5	20	54	25	20.9	6.94	3.14	2.5	74.4	90	125	34.4	45	50	28.6	35	45
No HEX, 2 Chiller	2	4x3x8	30	80	36	32.7	6.94	3.14	2.5	186.9	225	250	84.1	100	110	76.1	90	100
1 HEX, 2 Chiller	2	4x3x11.5	20	54	25	20.9	6.94	3.14	2.5	128.4	150	175	59.4	70	80	49.5	60	70
No HEX, 1 Chiller	1	4x3x8	40	104	47	39	6.94	3.14	2.5	136.9	175	225	61.9	80	100	51.3	70.0	90
1 HEX, 1 Chiller	1	5x4x11.5	25	68	31	25.4	6.94	3.14	2.5	91.9	110	150	41.9	50	70	34.3	45.0	50
No HEX, 2 Chiller	2	4x3x8	40	104	47	39	6.94	3.14	2.5	240.9	300	300	108.9	125	150.0	90.3	100.0	125
1 HEX, 2 Chiller	2	5x4x11.5	25	68	31	25.4	6.94	3.14	2.5	159.9	200	225	72.9	90	100.0	59.7	70.0	80
No HEX, 1 Chiller	1	5x5x13H	75	210	95	76	6.94	3.14	2.5	269.4	350	450	121.9	150	200	97.5	125	150
1 HEX, 1 Chiller	1	6x5x11.5	40	104	47	39	6.94	3.14	2.5	136.9	175	225	61.9	80	100	51.3	70	90
No HEX, 2 Chiller	2	5x5x13H	75	210	95	76	6.94	3.14	2.5	479.4	600	600	216.9	250	300	173.5	200	225
1 HEX, 2 Chiller	2	6x5x11.5	40	104	47	39	6.94	3.14	2.5	240.9	300	300	108.9	125	150	90.3	100	125
No HEX, 1 Chiller	1	6x5x15L	100	261	118	95	6.94	3.14	2.5	333.2	400	500	150.6	200	250	121.3	150	200
1 HEX, 1 Chiller	1	8x6x12M	50	130	59	49	6.94	3.14	2.5	169.4	225	250	76.9	100	125	63.8	80	110
No HEX, 2 Chiller	2	6x5x15L	100	261	118	95	6.94	3.14	2.5	594.2	700	800	268.6	300	350	216.3	250	300
1 HEX, 2 Chiller	2	8x6x12M	50	130	59	49	6.94	3.14	2.5	299.4	350	400	135.9	175	175	112.8	125	150

Dimensions and performance data

skid type	total head (ft)	skid head (ft)	external head (ft)	pipe mains size	system flow (GPM)	pressure drop (ft/100')	velocity (ft/sec)	bypass					skid				
								line size	flow (GPM)	PD (ft/100')	velocity (ft/sec)	pipe size	length	width	height	dry weight (lb) ± 10%	operating weight (lb) ± 10%
No HEX, 1 Chiller	166	86	80	3"	81	2.06	3.52	2.5"	41.8	1.82	2.81	2.5"	12'	7'	70"	5271	6156
1 HEX, 1 Chiller	109	109	N/A	3"	81	2.06	3.52	2.5"	N/A	N/A	N/A	N/A	17'	7'	83"	7394	8426
No HEX, 2 Chiller	166	86	80	4"	162	1.91	4.08	2.5"	41.8	1.82	2.81	2.5"	12'	7'	78"	6075	7102
1 HEX, 2 Chiller	109	109	N/A	4"	162	1.91	4.08	2.5"	N/A	N/A	N/A	N/A	17'	7'	83"	8391	9533
No HEX, 1 Chiller	166	86	80	4"	239	3.85	6.02	3"	80	2	3.47	3"	12'	7'	70"	5650	6677
1 HEX, 1 Chiller	109	109	N/A	4"	239	3.85	6.02	3"	N/A	N/A	N/A	N/A	17'	7'	86"	8647	10219
No HEX, 2 Chiller	166	86	80	6"	478	1.85	5.31	3"	80	2	3.47	3"	12'	7'	78"	7077	8617
1 HEX, 2 Chiller	109	109	N/A	6"	478	1.85	5.31	3"	N/A	N/A	N/A	N/A	17'	7'	86"	9846	11794
No HEX, 1 Chiller	167	87	80	5"	408	3.38	6.54	4"	136	1.39	3.43	4"	12'	7'	78"	6574	7859
1 HEX, 1 Chiller	110	110	N/A	5"	408	3.38	6.54	4"	N/A	N/A	N/A	N/A	17'	7'	100"	9678	11618
No HEX, 2 Chiller	167	87	80	8"	816	1.29	5.24	4"	136	1.39	3.43	4"	12'	7'	92"	9013	11573
1 HEX, 2 Chiller	110	110	N/A	8"	816	1.29	5.24	4"	N/A	N/A	N/A	N/A	17'	7'	100"	12251	15049
No HEX, 1 Chiller	161	81	80	6"	440	3.38	6.54	4"	263	4.58	6.63	4"	12'	7'	80"	7362	8865
1 HEX, 1 Chiller	104	104	N/A	6"	440	3.38	6.54	4"	N/A	N/A	N/A	N/A	17'	7'	100"	11433	13916
No HEX, 2 Chiller	161	81	80	8"	880	1.48	5.65	4"	263	4.58	6.63	4"	17'	7'	96"	9100	11660
1 HEX, 2 Chiller	104	104	N/A	8"	880	1.48	5.65	4"	N/A	N/A	N/A	N/A	17'	7'	100"	13406	16554
No HEX, 1 Chiller	161	81	80	6"	525	2.19	5.83	5"	314	2.1	5.03	5"	12'	7'	80"	7546	9085
1 HEX, 1 Chiller	104	104	N/A	6"	525	2.19	5.83	5"	N/A	N/A	N/A	N/A	17'	7'	100"	11994	14842
No HEX, 2 Chiller	161	81	80	8"	1050	2.04	6.74	5"	314	2.1	5.03	5"	17'	7'	100"	9430	11990
1 HEX, 2 Chiller	104	104	N/A	8"	1050	2.04	6.74	5"	N/A	N/A	N/A	N/A	17'	7'	105"	14027	17540
No HEX, 1 Chiller	159	79	80	8"	905	1.71	6.10	5"	375	2.93	6.01	5"	20'	10'	88"	12797	16310
1 HEX, 1 Chiller	102	102	N/A	8"	905	1.71	6.10	5"	N/A	N/A	N/A	N/A	25'	10'	116.5"	19697	24236
No HEX, 2 Chiller	159	79	80	10"	1810	1.79	7.36	5"	375	2.93	6.01	5"	22'	10'	96"	16589	20882
1 HEX, 2 Chiller	102	102	N/A	10"	1810	1.79	7.36	5"	N/A	N/A	N/A	N/A	27'	10'	116.5"	22441	28217
No HEX, 1 Chiller	165	85	80	8"	1293	3.01	8.30	6"	461	1.74	5.12	6"	26'	11'	88"	17600	21498
1 HEX, 1 Chiller	108	108	N/A	8"	1293	3.01	8.30	6"	N/A	N/A	N/A	N/A	31'	11'	116.5"	27348	34223
No HEX, 2 Chiller	165	85	80	12"	2586	1.5	7.41	6"	461	1.74	5.12	6"	28'	11'	105"	22469	28460
1 HEX, 2 Chiller	108	108	N/A	12"	2586	1.5	7.41	6"	N/A	N/A	N/A	N/A	33'	11'	116.5"	32151	40904

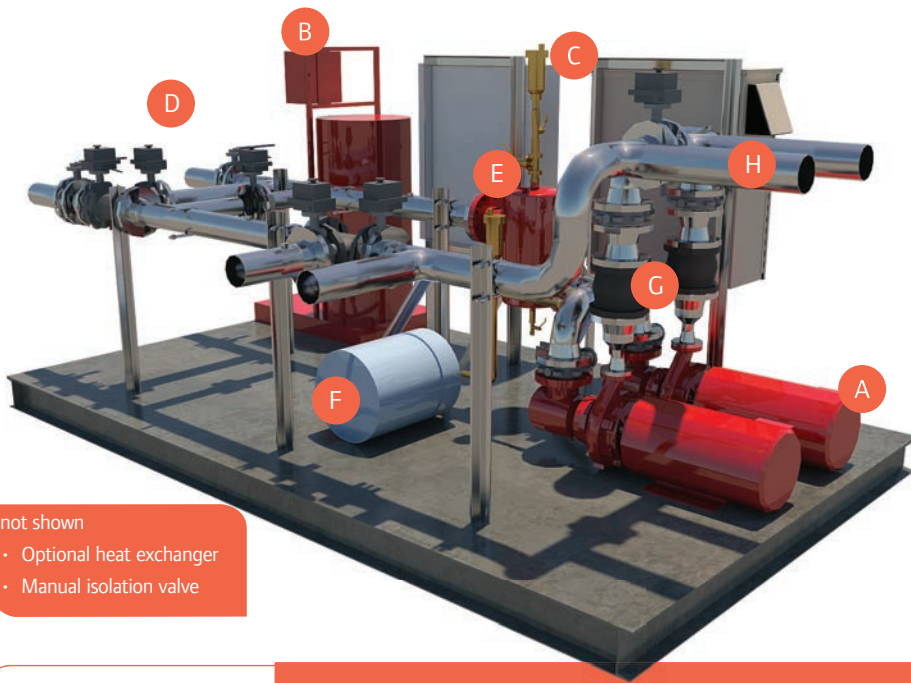

The system completion module includes all system hydronics specialties

- A Pumps (N+1)
- B Integral glycol feeder system
- C Control and electrical panels
- D Motorized control valves
- E Air separator
- F Expansion tank
- G Pump strainers
- H All connective piping

not shown

- Optional heat exchanger
- Manual isolation valve

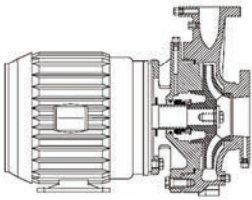

Pumps with TR200 communicating VFD

- Motor mounted horizontal end suction
- Heavy-duty, grease-lubricated ball bearings
- Self-lubricating silicon carbide mechanical seal

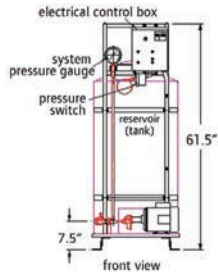

Glycol management system (standard)

CALMAC® glycol management system maintains the proper volume of coolant in a building's circulating loop by monitoring the system pressure and adding coolant from a reservoir when the pressure drops below a setpoint.

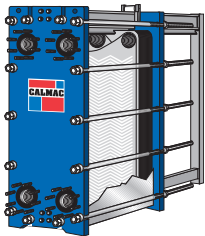

CALMAC heat exchangers

- True counter-current design for close temperature approach
- Unique interlocking plate design to help ensure a tight seal
- Deep set gasket grooves to improve reliability
- Bolted construction for strength and accessibility

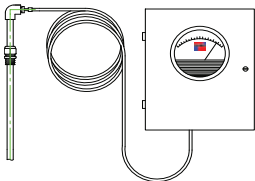

Inventory meter (optional)

- Indoor or outdoor field installation
- White-faced magnehelic display
- Factory-calibrated 4-20 mA output for remote monitoring

(Tracer® ice inventory calculation included as standard)

Quick Select Guide

This chart is meant to be used in the preliminary planning stages, before all information about the project is known. Once more detail is available, other tools such as Trane® Select Assist™ chiller selection software and CALMAC® IcePick™ should be used to verify system performance and completion of the project design. For more combinations contact your account manager. The assumptions embedded in this table may not be reflective of your specific project constraints. For example,

Chiller Model	Chiller Tons		6 Hours of Charge									7 Hours of Charge									8 Hours of Charge								
			Hours of Discharge									Hours of Discharge									Hours of Discharge								
			Day	Ice	6			8			10			6			8			10			6			8			10
CGAM 20	21	14	208	1	45	249	1	43	290	1	41	222	1	45	263	1	43	304	1	41	236	1	45	277	1	43	319	1	41
CGAM 26	26	19	268	1	50	321	1	48	373	1	46	287	1	50	339	1	48	392	1	46	306	1	50	358	1	48	410	1	46
CGAM 30	30	21	302	1	54	361	1	52	421	1	50	323	1	54	382	1	52	441	1	50	343	2	78	403	2	74	462	2	70
CGAM 35	35	24	352	1	59	421	1	57	491	1	55	376	2	83	445	2	79	515	2	75	400	2	83	470	2	79	539	2	75
CGAM 40	40	26	399	2	88	479	2	84	560	2	80	426	2	88	506	2	84	586	2	80	452	2	88	532	2	84	613	2	80
CGAM 52	52	36	530	2	100	633	2	96	737	2	92	566	2	100	670	2	96	774	2	92	603	2	100	706	2	96	810	2	92
CGAM 60	60	41	610	2	108	731	2	104	852	2	100	652	2	108	772	2	104	893	2	100	693	3	132	814	3	126	935	3	120
CGAM 70	71	49	723	2	119	865	2	115	1007	2	111	773	3	143	915	3	137	1057	3	131	822	3	143	964	3	137	1106	3	131
CGAM 80	82	56	831	3	154	995	3	148	1159	3	142	887	3	154	1051	3	148	1215	3	142	943	4	178	1108	4	170	1272	4	162
CGAM 90	92	64	932	3	164	1115	3	158	1298	3	152	995	3	164	1178	3	158	1362	3	152	1059	4	188	1242	4	180	1425	4	172
CGAM 100	104	71	1051	3	176	1258	3	170	1466	3	164	1122	4	200	1330	4	192	1537	4	184	1193	4	200	1401	4	192	1609	4	184
CGAM 110	112	78	1142	4	208	1366	4	200	1591	4	192	1219	4	208	1444	4	200	1669	4	192	1297	5	232	1522	5	222	1747	5	212
CGAM 120	121	85	1237	4	217	1480	4	209	1722	4	201	1322	4	217	1564	4	209	1807	4	201	1407	5	241	1649	5	231	1892	5	221
CGAM 130	132	92	1342	4	228	1606	4	220	1870	4	212	1433	5	252	1698	5	242	1962	5	232	1525	5	252	1789	5	242	2053	5	232
ACS 140	141	95	1416	4	237	1698	4	229	1980	4	221	1511	5	261	1793	5	251	2075	5	241	1605	6	285	1888	6	273	2170	6	261
ACS 160	154	105	1553	5	274	1862	5	264	2170	5	254	1658	5	274	1966	5	264	2275	5	254	1763	6	298	2071	6	286	2379	6	274
ACS 180	182	119	1805	5	302	2169	5	292	2532	5	282	1924	6	326	2288	6	314	2651	6	302	2043	7	350	2407	7	336	2770	7	322
ACS 200	194	127	1925	6	338	2312	6	326	2699	6	314	2052	6	338	2439	6	326	2827	6	314	2179	7	362	2566	7	348	2954	7	334
ACS 215	209	141	2098	6	353	2515	6	341	2932	6	329	2238	7	377	2656	7	363	3073	7	349	2379	8	401	2797	8	385	3214	8	369
ACS 230	224	152	2257	7	392	2705	7	378	3153	7	364	2409	8	416	2857	8	400	3305	8	384	2561	9	440	3009	9	422	3457	9	404
ACR150	155	98	1521	4	251	1831	4	243	2141	4	235	1619	5	275	1929	5	265	2239	5	255	1718	6	299	2028	6	287	2338	6	275
ACR165	174	110	1706	5	294	2054	5	284	2403	5	274	1816	6	318	2165	6	306	2513	6	294	1926	6	318	2275	6	306	2623	6	294
ACR180	188	119	1841	5	308	2216	5	298	2592	5	288	1960	6	332	2335	6	320	2711	6	308	2079	7	356	2454	7	342	2830	7	328
ACR200	209	132	2051	6	353	2470	6	341	2888	6	329	2183	7	377	2602	7	363	3021	7	349	2316	8	401	2734	8	385	3153	8	369
ACR225	242	156	2389	7	410	2873	7	396	3357	7	382	2545	8	434	3029	8	418	3513	8	402	2701	9	458	3185	9	440	3669	9	422
ACR250	260	168	2572	7	428	3093	7	414	3614	7	400	2740	8	452	3261	8	436	3782	8	420	2908	9	476	3429	9	458	3950	9	440
ACR275	285	182	2804	8	477	3375	8	461	3945	8	445	2987	9	501	3557	9	483	4128	9	465	3169	10	525	3739	10	505	4310	10	485
ACR300	318	202	3118	9	534	3754	9	516	4390	9	498	3320	10	558	3956	10	538	4592	10	518	3522	11	582	4158	11	560	4794	11	538
			Peak Cooling Discharge (tons)									Peak Cooling Discharge (tons)									Peak Cooling Discharge (tons)								
			Number of CALMAC® 1190 Modules									Number of CALMAC 1190 Modules									Number of CALMAC 1190 Modules								
			Partial Storage System Capacity (ton-hours)									Partial Storage System Capacity (ton-hours)									Partial Storage System Capacity (ton-hours)								

this table is set up for one chiller, and your project may have more than one chiller capable of making ice. Flow, pressure limits, and other constraints may be higher than you desire. Careful consideration of all the relevant project application requirements is essential prior to finalizing the system design.

Chiller Model	Chiller Tons		9 Hours of Charge									10 Hours of Charge									11 Hours of Charge								
			Hours of Discharge									Hours of Discharge									Hours of Discharge								
	Day	Ice	6			8			10			6			8			10			6			8			10		
CGAM 20	21	14	250	1	45	291	1	43	333	1	41	264	1	45	306	1	43	347	1	41	278	2	69	320	2	65	361	2	61
CGAM 26	26	19	324	2	74	376	2	70	429	2	66	343	2	74	395	2	70	447	2	66	361	2	74	414	2	70	466	2	66
CGAM 30	30	21	364	2	78	423	2	74	483	2	70	384	2	78	444	2	74	503	2	70	405	2	78	464	2	74	524	2	70
CGAM 35	35	24	424	2	83	494	2	79	563	2	75	449	2	83	518	2	79	587	2	75	473	2	83	542	2	79	611	2	75
CGAM 40	40	26	479	2	88	559	2	84	639	2	80	505	2	88	585	2	84	665	2	80	531	2	88	612	2	84	692	2	80
CGAM 52	52	36	639	3	124	743	3	118	846	3	112	675	3	124	779	3	118	883	3	112	712	3	124	815	3	118	919	3	112
CGAM 60	60	41	735	3	132	855	3	126	976	3	120	776	3	132	897	3	126	1017	3	120	818	4	156	938	4	148	1059	4	140
CGAM 70	71	49	871	3	143	1014	3	137	1156	3	131	921	3	143	1063	4	159	1205	4	151	970	4	167	1112	4	159	1255	4	151
CGAM 80	82	56	1000	4	178	1164	4	170	1328	4	162	1056	4	178	1220	4	170	1384	4	162	1113	5	202	1277	5	192	1441	5	182
CGAM 90	92	64	1123	4	188	1306	4	180	1489	4	172	1186	4	188	1369	5	202	1553	5	192	1250	5	212	1433	5	202	1616	5	192
CGAM 100	104	71	1265	5	224	1472	5	214	1680	5	204	1336	5	224	1544	5	214	1751	5	204	1407	6	248	1615	6	236	1822	6	224
CGAM 110	112	78	1375	5	232	1600	5	222	1825	5	212	1453	5	232	1678	6	244	1903	6	232	1531	6	256	1756	6	244	1980	6	232
CGAM 120	121	85	1492	6	265	1734	6	253	1977	6	241	1577	6	265	1819	6	253	2062	6	241	1662	7	289	1904	7	275	2147	7	261
CGAM 130	132	92	1617	6	276	1881	6	264	2145	6	252	1708	6	276	1972	7	286	2237	7	272	1800	7	300	2064	7	286	2328	7	272
ACS 140	141	95	1700	6	285	1982	6	273	2265	6	261	1795	6	285	2077	7	295	2359	7	281	1890	7	309	2172	7	295	2454	7	281
ACS 160	154	105	1867	7	322	2176	7	308	2484	7	294	1972	7	322	2280	7	308	2589	7	294	2077	8	346	2385	8	330	2693	8	314
ACS 180	182	119	2162	8	374	2526	8	358	2889	8	342	2281	8	374	2645	8	358	3008	8	342	2400	9	398	2764	9	380	3127	9	362
ACS 200	194	127	2306	8	386	2693	8	370	3081	8	354	2433	8	386	2820	9	392	3208	9	374	2560	10	434	2947	10	414	3335	10	394
ACS 215	209	141	2520	9	425	2938	9	407	3355	9	389	2661	9	425	3079	10	429	3496	10	409	2802	11	473	3220	11	451	3637	11	429
ACS 230	224	152	2713	10	464	3161	10	444	3609	10	424	2865	10	464	3313	11	466	3761	11	444	3018	12	512	3465	12	488	3913	12	464
ACR150	155	98	1816	6	299	2126	6	287	2436	6	275	1915	6	299	2225	7	309	2535	7	295	2013	8	347	2323	8	331	2633	8	315
ACR165	174	110	2037	7	342	2385	7	328	2733	7	314	2147	7	342	2495	8	350	2843	8	334	2257	9	390	2605	9	372	2954	9	354
ACR180	188	119	2198	8	380	2573	8	364	2949	8	348	2317	8	380	2692	8	364	3068	8	348	2436	9	404	2811	9	386	3187	9	368
ACR200	209	132	2448	8	401	2867	8	385	3286	8	369	2581	8	401	2999	9	407	3418	9	389	2713	10	449	3132	10	429	3551	10	409
ACR225	242	156	2857	10	482	3341	10	462	3825	10	442	3013	10	482	3497	11	484	3981	11	462	3169	12	530	3653	12	506	4137	12	482
ACR250	260	168	3077	11	524	3597	11	502	4118	11	480	3245	11	524	3766	12	524	4287	12	500	3413	13	572	3934	13	546	4455	13	520
ACR275	285	182	3351	11	549	3921	11	527	4492	11	505	3533	11	549	4103	13	571	4674	13	545	3715	14	621	4286	14	593	4856	14	565
ACR300	318	202	3724	13	630	4359	13	604	4995	13	578	3925	13	630	4561	14	626	5197	14	598	4127	15	678	4763	15	648	5399	15	618
			Peak Cooling Discharge (tons)									Peak Cooling Discharge (tons)									Peak Cooling Discharge (tons)								
			Number of CALMAC® 1190 Modules									Number of CALMAC 1190 Modules									Number of CALMAC 1190 Modules								
			Partial Storage System Capacity (ton-hours)									Partial Storage System Capacity (ton-hours)									Partial Storage System Capacity (ton-hours)								

Quick Select Guide, continued

Chiller Model	Chiller Tons		6 Hours of Charge									7 Hours of Charge									8 Hours of Charge								
			Hours of Discharge									Hours of Discharge									Hours of Discharge								
	Day	Ice	6			8			10			6			8			10			6			8			10		
RTAC 140S	149	100	1495	4	245	1794	4	237	2092	4	229	1595	5	269	1893	5	259	2192	5	249	1695	6	293	1993	6	281	2292	6	269
RTAC 140H	153	101	1526	5	273	1833	5	263	2140	5	253	1627	5	273	1934	5	263	2241	5	253	1728	6	297	2035	6	285	2342	6	273
RTAC 155S	163	110	1638	5	283	1964	5	273	2291	5	263	1748	6	307	2074	6	295	2401	6	283	1858	6	307	2184	6	295	2511	6	283
RTAC 155H	169	112	1690	5	289	2028	5	279	2367	5	269	1803	6	313	2141	6	301	2479	6	289	1915	6	313	2253	6	301	2592	6	289
RTAC 170S	179	121	1801	5	299	2159	5	289	2517	5	279	1923	6	323	2280	6	311	2638	6	299	2044	7	347	2402	7	333	2759	7	319
RTAC 170H	184	123	1839	5	304	2207	5	294	2575	5	284	1962	6	328	2330	6	316	2698	6	304	2085	7	352	2453	7	338	2820	7	324
RTAC 185S	195	133	1969	6	339	2359	6	327	2748	6	315	2102	7	363	2492	7	349	2882	7	335	2235	8	387	2625	8	371	3015	8	355
RTAC 185H	203	136	2034	6	347	2440	6	335	2845	6	323	2170	7	371	2576	7	357	2982	7	343	2306	8	395	2712	8	379	3118	8	363
RTAC 200S	212	146	2148	6	356	2573	6	344	2998	6	332	2294	7	380	2718	7	366	3143	7	352	2439	8	404	2864	8	388	3289	8	372
RTAC 200H	221	149	2217	6	365	2659	6	353	3100	6	341	2366	7	389	2807	7	375	3249	7	361	2515	8	413	2956	8	397	3398	8	381
RTAC 225S	235	162	2380	7	403	2850	7	389	3320	7	375	2541	8	427	3011	8	411	3481	8	395	2703	9	451	3173	9	433	3643	9	415
RTAC 225H	239	161	2402	7	407	2879	7	393	3357	7	379	2563	8	431	3041	8	415	3519	8	399	2724	9	455	3202	9	437	3680	9	419
RTAC 250S	256	176	2597	8	448	3109	8	432	3622	8	416	2773	9	472	3286	9	454	3798	9	436	2949	10	496	3462	10	476	3975	10	456
RTAC 250H	264	179	2654	8	456	3181	8	440	3709	8	424	2832	9	480	3360	9	462	3887	9	444	3011	10	504	3538	10	484	4066	10	464
RTAC 275S	284	195	2874	8	476	3443	8	460	4012	8	444	3069	10	524	3637	10	504	4206	10	484	3263	11	548	3832	11	526	4401	11	504
RTAC 275H	296	198	2962	8	488	3554	8	472	4146	8	456	3160	10	536	3752	10	516	4344	10	496	3358	11	560	3950	11	538	4542	11	516
RTAC 300S	320	220	3239	9	536	3879	9	518	4519	9	500	3458	11	584	4099	11	562	4739	11	540	3678	12	608	4318	12	584	4958	12	560
RTAC 300H	331	223	3326	9	547	3989	9	529	4652	9	511	3549	11	595	4212	11	573	4875	11	551	3772	12	619	4435	12	595	5098	12	571
RTAC 350S	364	250	3682	10	604	4409	10	584	5137	10	564	3932	12	652	4659	12	628	5387	12	604	4182	14	700	4909	14	672	5637	14	644
RTAC 350H	374	253	3761	11	638	4509	11	616	5258	11	594	4013	12	662	4762	12	638	5511	12	614	4266	14	710	5014	14	682	5763	14	654
RTAC 400S	432	299	4384	12	720	5247	12	696	6111	12	672	4682	14	768	5546	14	740	6410	14	712	4981	16	816	5845	16	784	6709	16	752
RTAC 400H	448	304	4507	13	760	5402	13	734	6297	13	708	4810	15	808	5706	15	778	6601	15	748	5114	17	856	6009	17	822	6904	17	788
RTAC 450S	476	330	4834	14	812	5786	14	784	6738	14	756	5164	16	860	6116	16	828	7068	16	796	5494	18	908	6445	18	872	7397	18	836
RTAC 500S	520	360	5281	15	880	6320	15	850	7360	15	820	5641	17	928	6681	17	894	7720	17	860	6001	20	1000	7041	20	960	8080	20	920

RTAF 115	115	75	1136	3	187	1366	3	181	1595	3	175	1211	4	211	1440	4	203	1670	4	195	1286	4	211	1515	4	203	1744	4	195
RTAF 130	131	87	1307	4	227	1570	4	219	1833	4	211	1394	5	251	1657	5	241	1919	5	231	1480	5	251	1743	5	241	2006	5	231
RTAF 150	155	101	1533	5	275	1843	5	265	2152	5	255	1633	5	275	1943	5	265	2253	5	255	1734	6	299	2044	6	287	2354	6	275
RTAF 170	169	111	1680	5	289	2018	5	279	2356	5	269	1791	6	313	2129	6	301	2467	6	289	1902	6	313	2240	6	301	2578	6	289
RTAF 180	183	122	1831	5	303	2198	5	293	2564	5	283	1953	6	327	2320	6	315	2686	6	303	2075	7	351	2442	7	337	2808	7	323
RTAF 200	204	133	2022	6	348	2429	6	336	2836	6	324	2155	7	372	2562	7	358	2969	7	344	2288	8	396	2695	8	380	3103	8	364
RTAF 215	221	145	2190	6	365	2631	6	353	3072	6	341	2335	7	389	2776	7	375	3217	7	361	2479	8	413	2920	8	397	3361	8	381
RTAF 230	232	153	2309	7	400	2772	7	386	3235	7	372	2462	8	424	2925	8	408	3389	8	392	2615	9	448	3079	9	430	3542	9	412
RTAF 250	250	166	2498	7	418	2998	7	404	3498	7	390	2665	8	442	3165	8	426	3665	8	410	2831	9	466	3331	9	448	3831	9	430
RTAF 270	268	181	2694	8	460	3230	8	444	3766	8	428	2875	9	484	3411	9	466	3947	9	448	3056	10	508	3592	10	488	4128	10	468
RTAF 280	288	190	2869	8	480	3445	8	464	4022	8	448	3059	9	504	3635	9	486	4212	9	468	3249	11	552	3825	11	530	4402	11	508
RTAF3 10	319	211	3177	9	535	3815	9	517	4452	9	499	3388	10	559	4025	10	539	4663	10	519	3599	12	607	4236	12	583	4874	12	559
RTAF 350	354	237	3545	10	594	4253	10	574	4961	10	554	3782	12	642	4490	12	618	5198	12	594	4018	13	666	4727	13	640	5435	13	614
RTAF 390	394	269	3979	11	658	4766	11	636	5554	11	614	4248	13	706	5036	13	680	5823	13	654	4518	15	754	5305	15	724	6093	15	694
RTAF 410	423	281	4225	12	711	5070	12	687	5916	12	663	4506	14	759	5352	14	731	6197	14	703	4788	16	807	5633	16	775	6479	16	743
RTAF 450	467	309	4655	13	779	5589	13	753	6522	13	727	4965	15	827	5898	15	797	6831	15	767	5274	17	875	6207	17	841	7141	17	807
RTAF 500	500	334	5006	14	836	6006	14	808	7006	14	780	5341	16	884	6341	16	852	7341	16	820	5675	18	932	6675	18	896	7675	18	860
RTAF 520	520	351	5228	15	880	6269	15	850	7310	15	820	5579	17	928	6620	17	894	7661	17	860	5930	19	976	6971	19	938	8012	19	900
			Peak Cooling Discharge (tons)									Peak Cooling Discharge (tons)									Peak Cooling Discharge (tons)								
			Number of CALMAC® 1190 Modules									Number of CALMAC 1190 Modules									Number of CALMAC 1190 Modules								
			Partial Storage System Capacity (ton-hours)									Partial Storage System Capacity (ton-hours)									Partial Storage System Capacity (ton-hours)								

			9 Hours of Charge									10 Hours of Charge									11 Hours of Charge								
Chiller Model	Chiller Tons		Hours of Discharge									Hours of Discharge									Hours of Discharge								
	Day	Ice	6			8			10			6			8			10			6			8			10		
RTAC 140S	149	100	1795	6	293	2093	6	281	2392	6	269	1895	6	293	2193	7	303	2492	7	289	1995	8	341	2293	8	325	2592	8	309
RTAC 140H	153	101	1829	7	321	2136	7	307	2443	7	293	1930	7	321	2237	7	307	2544	7	293	2031	8	345	2338	8	329	2645	8	313
RTAC 155S	163	110	1968	7	331	2294	7	317	2621	7	303	2078	7	331	2404	8	339	2731	8	323	2188	9	379	2514	9	361	2840	9	343
RTAC 155H	169	112	2027	7	337	2366	7	323	2704	7	309	2140	7	337	2478	8	345	2817	8	329	2252	9	385	2591	9	367	2929	9	349
RTAC 170S	179	121	2165	8	371	2523	8	355	2881	8	339	2287	8	371	2644	9	377	3002	9	359	2408	9	395	2766	9	377	3123	9	359
RTAC 170H	184	123	2208	8	376	2575	8	360	2943	8	344	2330	8	376	2698	9	382	3066	9	364	2453	9	400	2821	9	382	3189	9	364
RTAC 185S	195	133	2368	8	387	2758	8	371	3148	8	355	2501	8	387	2891	9	393	3281	9	375	2635	10	435	3025	10	415	3414	10	395
RTAC 185H	203	136	2443	9	419	2848	9	401	3254	9	383	2579	9	419	2984	10	423	3390	10	403	2715	10	443	3121	10	423	3526	10	403
RTAC 200S	212	146	2585	9	428	3010	9	410	3434	9	392	2730	9	428	3155	10	432	3580	10	412	2876	11	476	3301	11	454	3726	11	432
RTAC 200H	221	149	2664	9	437	3105	9	419	3546	9	401	2812	9	437	3254	10	441	3695	10	421	2961	11	485	3403	11	463	3844	11	441
RTAC 225S	235	162	2864	10	475	3334	10	455	3804	10	435	3026	10	475	3496	11	477	3966	11	455	3187	12	523	3657	12	499	4127	12	475
RTAC 225H	239	161	2886	10	479	3364	10	459	3841	10	439	3047	10	479	3525	11	481	4003	11	459	3208	12	527	3686	12	503	4164	12	479
RTAC 250S	256	176	3126	11	520	3639	11	498	4151	11	476	3302	11	520	3815	12	520	4328	12	496	3479	13	568	3991	13	542	4504	13	516
RTAC 250H	264	179	3189	11	528	3717	11	506	4244	11	484	3368	11	528	3895	12	528	4423	12	504	3547	14	600	4074	14	572	4601	14	544
RTAC 275S	284	195	3458	12	572	4027	12	548	4595	12	524	3653	12	572	4221	13	570	4790	13	544	3847	15	644	4416	15	614	4985	15	584
RTAC 275H	296	198	3555	12	584	4147	12	560	4739	12	536	3753	12	584	4345	14	604	4937	14	576	3951	15	656	4543	15	626	5135	15	596
RTAC 300S	320	220	3898	14	656	4538	14	628	5178	14	600	4117	14	656	4757	15	650	5398	15	620	4337	17	728	4977	17	694	5617	17	660
RTAC 300H	331	223	3995	14	667	4658	14	639	5321	14	611	4218	14	667	4880	15	661	5543	15	631	4440	17	739	5103	17	705	5766	17	671
RTAC 350S	364	250	4432	15	724	5159	15	694	5887	15	664	4682	15	724	5409	17	738	6137	17	704	4932	19	820	5659	19	782	6387	19	744
RTAC 350H	374	253	4518	16	758	5267	16	726	6016	16	694	4771	16	758	5520	17	748	6268	17	714	5023	19	830	5772	19	792	6521	19	754
RTAC 400S	432	299	5280	18	864	6144	18	828	7007	18	792	5579	18	864	6442	20	872	7306	20	832	5877	22	960	6741	22	916	7605	22	872
RTAC 400H	448	304	5418	19	904	6313	19	866	7208	19	828	5721	19	904	6616	21	910	7511	21	868	6025	23	1000	6920	23	954	7815	23	908
RTAC 450S	476	330	5823	20	956	6775	20	916	7727	20	876	6153	20	956	7105	22	960	8057	22	916	6483	25	1076	7435	25	1026	8387	25	976
RTAC 500S	520	360	6362	22	1048	7401	22	1004	8441	22	960	6722	22	1048	7762	25	1070	8801	25	1020	7082	27	1168	8122	27	1114	9161	27	1060

RTAF 115	115	75	1360	5	235	1590	5	225	1819	5	215	1435	5	235	1664	5	225	1894	5	215	1510	6	259	1739	6	247	1968	6	235
RTAF 130	131	87	1567	6	275	1830	6	263	2092	6	251	1653	6	275	1916	6	263	2179	6	251	1740	7	299	2003	7	285	2265	7	271
RTAF 150	155	101	1835	7	323	2144	7	309	2454	7	295	1935	7	323	2245	7	309	2555	7	295	2036	8	347	2346	8	331	2655	8	315
RTAF 170	169	111	2013	7	337	2351	7	323	2689	7	309	2124	7	337	2462	8	345	2800	8	329	2235	9	385	2573	9	367	2911	9	349
RTAF 180	183	122	2197	8	375	2563	8	359	2930	8	343	2319	8	375	2685	9	381	3052	9	363	2441	9	399	2807	9	381	3174	9	363
RTAF 200	204	133	2422	9	420	2829	9	402	3236	9	384	2555	9	420	2962	9	402	3369	9	384	2688	10	444	3095	10	424	3503	10	404
RTAF 215	221	145	2624	9	437	3065	9	419	3506	9	401	2768	9	437	3209	10	441	3650	10	421	2913	11	485	3354	11	463	3795	11	441
RTAF 230	232	153	2769	10	472	3232	10	452	3695	10	432	2922	10	472	3385	11	474	3848	11	452	3075	12	520	3538	12	496	4002	12	472
RTAF 250	250	166	2998	10	490	3498	10	470	3997	10	450	3164	10	490	3664	12	514	4164	12	490	3331	13	562	3831	13	536	4330	13	510
RTAF 270	268	181	3237	11	532	3773	11	510	4309	11	488	3419	11	532	3954	13	554	4490	13	528	3600	14	604	4136	14	576	4671	14	548
RTAF 280	288	190	3439	12	576	4016	12	552	4592	12	528	3629	12	576	4206	13	574	4782	13	548	3819	14	624	4396	14	596	4972	14	568
RTAF3 10	319	211	3810	13	631	4447	13	605	5085	13	579	4021	13	631	4658	15	649	5295	15	619	4232	16	703	4869	16	671	5506	16	639
RTAF 350	354	237	4255	15	714	4963	15	684	5671	15	654	4492	15	714	5200	16	706	5908	16	674	4729	18	786	5437	18	750	6145	18	714
RTAF 390	394	269	4787	17	802	5575	17	768	6362	17	734	5057	17	802	5844	18	790	6631	18	754	5326	20	874	6113	20	834	6901	20	794
RTAF 410	423	281	5069	17	831	5915	17	797	6760	17	763	5351	17	831	6196	19	841	7042	19	803	5632	21	927	6478	21	885	7323	21	843
RTAF 450	467	309	5583	19	923	6517	19	885	7450	19	847	5893	19	923	6826	21	929	7759	21	887	6202	23	1019	7135	23	973	8068	23	927
RTAF 500	500	334	6010	21	1004	7010	21	962	8010	21	920	6344	21	1004	7344	23	1006	8344	23	960	6679	25	1100	7679	25	1050	8679	25	1000
RTAF 520	520	351	6281	22	1048	7322	22	1004	8363	22	960	6632	22	1048	7673	24	1048	8714	24	1000	6983	26	1144	8024	26	1092	9065	26	1040
			Peak Cooling Discharge (tons)									Peak Cooling Discharge (tons)									Peak Cooling Discharge (tons)								
			Number of CALMAC® 1190 Modules									Number of CALMAC 1190 Modules									Number of CALMAC 1190 Modules								
			Partial Storage System Capacity (ton-hours)									Partial Storage System Capacity (ton-hours)									Partial Storage System Capacity (ton-hours)								



Trane - by Trane Technologies (NYSE: TT), a global climate innovator - creates comfortable, energy efficient indoor environments for commercial and residential applications. For more information, please visit trane.com or tranetechnologies.com.

Trane has a policy of continuous product and product data improvement and reserves the right to change design and specifications without notice. We are committed to using environmentally conscious print practices.

Trane, the Circle Logo, Let's Go Beyond, Tracer, Concierge, Air-Fi, eFlex, ReliaTel, TRACE, VariTrane, Voyager, Precedent, TOPSS, Traq are trademarks of Trane in the United States and other countries. ASHRAE is a trademark of the American Society of Heating, Refrigerating, and Air-Conditioning Engineers, Inc. ZigBee is a trademark of ZigBee Alliance. ANSI is a trademark of American National Standards Institute, Inc. All trademarks referenced are the trademarks of their respective owners.