



Product Catalog

HFCF PEAK

Horizontal Concealed Chilled Water
Fan Coil Unit

Airflow: 200~1500 CFM



Features and Benefits

Overview

HFCF is another leap over the leading HFCE, working everywhere around the world. HFCF meets the standards of today's market, as well as the anticipated needs of tomorrow's market. The tradition that company founder Reuben Trane began in the 1930s continues with the latest generation of fan-coils from The Trane Company.

The best design we are offering by HFCF:

- Louver fin to drive higher heat transfer efficiency
- Larger diameter fan to further improve noise level
- Various ESP (External Static Pressure) motor options to provide more precise match
- Dedicated EarthWise™ (large delta T application) coil option
- Full AQP in design and production process to ensure quality delivery
- Many newly patented designs to deliver unique comfort

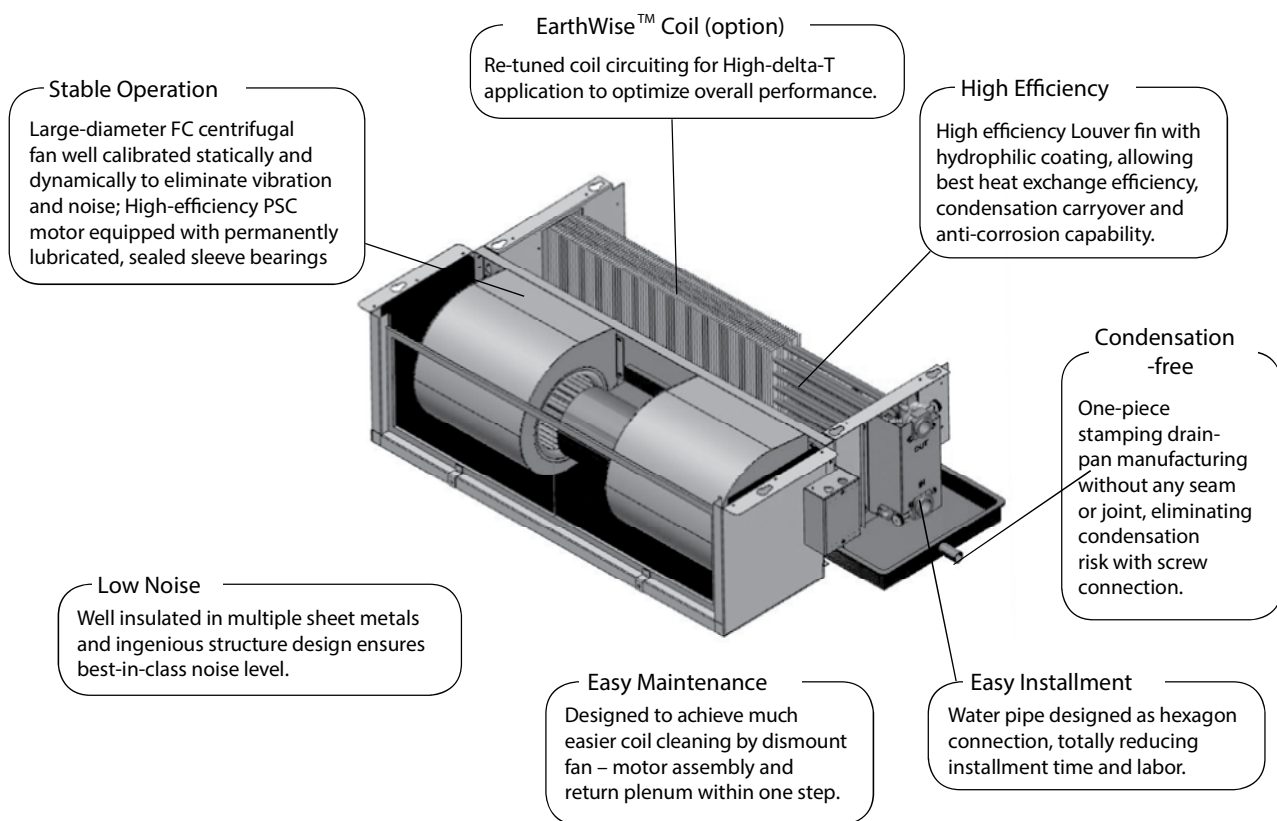

Model Number Descriptions

H F C F 0 2 L 3 0 1 1 0 0 0 A 0 2 A T
 1 2 3 4 5 6 7 8 9 10 11 12 13 14 15 16 17 18 19

Digits 1-4	Unit Type H Horizontal F Fan Coil Unit C Concealed F Platform Version	Digit 12	Valve 0 None
Digits 5-6	Size--Nominal CFM 02 200 CFM 03 300 CFM 04 400 CFM 05 500 CFM 06 600 CFM 08 800 CFM 10 1000 CFM 11 1100 CFM 12 1200 CFM 13 1300 CFM 14 1400 CFM 15 1500 CFM	Digit 13	Control 0 No Control A LCD Thermostat (TM50)
Digit 7	Connection Side L Left Hand Connection R Right Hand Connection	Digit 14	Plenum Filter 0 None A Rear Return Air Plenum B Rear Return Air Plenum w/ 6mm Nylon Filter C Rear Return Air Plenum w/ 20mm AI Filter D Bottom Return Air Plenum E Bottom Return Air Plenum w/ 6mm Nylon Filter F Bottom Return Air Plenum w/ 20mm AI Filter
Digit 8	Coil Rows 2 2 rows 3 3 rows 4 4 rows C 3 rows (EarthWise) D 4 rows (EarthWise) H 3 rows hi-capacity (EarthWise) 6 2 rows, [2.5MPa] 7 3 rows, [2.5MPa] 8 4 rows, [2.5MPa] R 3 rows (EarthWise), [2.5MPa] S 4 rows (EarthWise), [2.5MPa] W 3 rows hi-capacity (EarthWise), [2.5MPa]	Digit 15	Drain Pan A Cold-roll Steel, PE Insulation B Cold-roll Steel, PE Insulation (+200mm) C Cold-roll Steel, PE Insulation (+310mm) D Stainless Steel, PE Insulation E Stainless Steel, PE Insulation (+200mm) F Stainless Steel, PE Insulation (+310mm) G Cold-roll Steel, Non-flammable Insulation H Cold-roll Steel, Non-flammable Insulation (+200mm) J Cold-roll Steel w/ Non-flammable Insulation (+310mm) K Stainless Steel w/ Non-flammable Insulation L Stainless Steel w/ Non-flammable Insulation (+200mm) M Stainless Steel w/ Non-flammable Insulation (+310mm) N Cold-roll Steel, PE Insulation + aux drain pan
Digit 9	Electric Heater 0 No Electric Heater 1 With Electric Heater (w/ Relay in Terminal Box)	Digit 16	IAQ Option 0 No IAQ Option
Digit 10	Motor Type 1 PSC Motor-ESP 12Pa 3 PSC Motor-ESP 30Pa 5 PSC Motor-ESP 50Pa A PSC Motor-ESP 100Pa	Digit 17	Design Version 2 Design Version
Digit 11	Voltage/Hertz/Phase 1 220~240VAC/50Hz/1Phase 2 220~240VAC/60Hz/1Phase	Digit 18	Region A APR
		Digit 19	Factory Edition T Thailand

Performance Data

3 Row Unit (2-Pipe, 12/30/50Pa Motor)

			02	03	04	05	06	08	10	12	14	
Air Flow	High Speed	CMH	340	510	680	850	1020	1360	1700	2040	2380	
	Middle Speed	CMH	280	410	550	690	830	1100	1360	1630	1900	
	Low Speed	CMH	180	270	350	440	520	690	860	1020	1190	
Normal Application ⁽²⁾	Cooling Capacity	kW	2.21	3.16	4.17	5.06	6.10	8.00	9.30	11.10	13.00	
	Heating Capacity	kW	3.50	5.20	6.70	8.12	9.70	13.00	15.50	18.00	20.80	
	Heating Capacity (by E-heater) ⁽⁵⁾	kW	0.50	1.00	1.40	1.60	1.80	2.80	3.20	3.60	4.60	
	Water Flow	l/s	0.11	0.15	0.20	0.25	0.30	0.39	0.45	0.53	0.63	
EarthWise Application ⁽³⁾	Water Pressure Drop	kPa	25	24	25	30	40	35	35	40	50	
	Cooling Capacity	kW	2.21	3.14	3.99	5.02	6.10	7.98	9.85	11.31	13.29	
	Heating Capacity	kW	3.37	4.84	6.32	7.56	9.16	12.27	14.92	17.15	19.95	
	Water Flow	l/s	0.07	0.10	0.12	0.16	0.20	0.24	0.29	0.34	0.40	
High Capacity EarthWise Application	Water Pressure Drop	kPa	29	22	17	29	40	33	36	35	50	
	Cooling Capacity	kW	-	2.06	2.70	3.39	4.20	5.41	6.53	7.49	8.87	
	Heating Capacity	kW	-	3.61	4.73	5.93	7.35	9.47	11.43	13.11	15.52	
	Water Flow	l/s	-	0.06	0.08	0.11	0.12	0.16	0.19	0.22	0.27	
Power Consumption	12Pa	220 ~ 240V/50Hz	W	26	39	45	68	96	115	152	189	228
		220 ~ 240V/60Hz		27	43	51	67	85	109	142	178	213
	30Pa	220 ~ 240V/50Hz		41	55	71	87	108	142	174	212	253
		220 ~ 240V/60Hz		36	49	62	87	88	119	163	193	311
	50Pa	220 ~ 240V/50Hz		48	64	84	99	118	158	210	230	290
		220 ~ 240V/60Hz		40	58	77	112	134	149	242	273	333
Noise	12Pa	dBA	34.5	35.5	36.5	40.5	45.0	44	46.5	49.0	51.0	
	30Pa		38.0	40.0	41.5	43.5	46.0	46.5	49.0	51.0	53.0	
	50Pa		41.0	42.5	45.0	47.0	48.0	49.0	51.0	52.0	54.0	
Number of Motors			1	1	1	1	1	2	2	2	2	
Working Pressure			1.8MPa									
Coil Type			Copper Tube / Hydrophilic Aluminum Fin									
Fan Type			Forward-Curve Centrifugal Fan									
Motor Type			Single-phase Permanent Split Capacitor									
Water Inlet/Outlet Diameter			Rc 3/4" (Female)									
Drain-pan Type			One-piece Stamping & Electrostatic Coating									
Drain-pan Connection Diameter			R 3/4" (Male)									
Options			Return Air Plenum, Filter, Thermostat, E-heater, Special Drain-pan									

1. Cooling and heating capacity, water flow and pressure drop data are based on high speed running of bare unit (i.e. without return air plenum).

2. Normal Operation:

- Cooling operation: inlet air dry/wet bulb temperature (°C): 27/19.5; water inlet/outlet temperature (°C): 7/12;
- Heating operation: inlet air dry bulb temperature (°C): 21; water inlet temperature (°C): 60; same water flow as cooling operation;

3. EarthWise Operation:

- Cooling operation: inlet air dry/wet bulb temperature (°C): 27/19.5; water inlet/outlet temperature (°C): 5/13;
- Heating operation: inlet air dry bulb temperature (°C): 21; water inlet temperature (°C): 60; same water flow as cooling operation;

4. High Capacity EarthWise operation:

- Cooling operation: inlet air dry/wet bulb temperature (°C): 26.7 °C/19.4 °C; water inlet/outlet temperature (°C): 7.2 °C/15.6 °C;
- Heating operation: inlet air dry bulb temperature (°C): 21; water inlet temperature (°C): 60; same water flow as cooling operation;

5. Same performance for EarthWise application.

6. High capacity EarthWise application data is based on medium speed. Other data is based on high speed.

3 Row Unit (2-Pipe, 100Pa Motor)

			11	13	15
Air Flow	High Speed	CMH	1870	2210	2550
	Middle Speed	CMH	1700	1870	2040
	Low Speed	CMH	935	1105	1275
Normal Application	Cooling Capacity	kW	9.78	11.72	13.48
	Heating Capacity	kW	16.41	19.02	21.67
	Heating Capacity (by E-heater) ⁽⁵⁾	kW	3.20	3.60	4.60
	Water Flow	l/s	0.47	0.56	0.64
	Water Pressure Drop	kPa	38	44	53
EarthWise Application	Cooling Capacity	kW	10.42	11.96	13.80
	Heating Capacity	kW	15.81	18.12	20.73
	Water Flow	l/s	0.31	0.36	0.41
	Water Pressure Drop	kPa	40	38	53
High Capacity EarthWise Application	Cooling Capacity	kW	703	758	906
	Heating Capacity	kW	12.30	13.26	15.86
	Water Flow	l/s	0.20	0.22	0.27
	Water Pressure Drop	kPa	38	36	49
Power Consumption (220~240V/50Hz)	High Speed	W	296	303	376
	Medium Speed	W	254	286	312
	Low Speed	W	141	215	227
Power Consumption (220~240V/60Hz)	High Speed	W	319	359	400
	Medium Speed	W	296	318	354
	Low Speed	W	165	243	265
Noise	High Speed	dBA	56.0	57.0	58.0
	Medium Speed	dBA	55.0	55.5	55.5
	Low Speed	dBA	51.5	51.5	51.5
Number of Motors			2	2	2
Working Pressure			1.8MPa		
Coil Type			Copper Tube / Hydrophilic Aluminum Fin		
Fan Type			Forward-Curve Centrifugal Fan		
Motor Type			Single-phase Permanent Split Capacitor		
Water Inlet/Outlet Diameter			Rc 3/4" (Female)		
Drain-pan Type			One-piece Stamping & Electrostatic Coating		
Drain-pan Connection Diameter			R 3/4"(Male)		
Options			Return Air Plenum, Filter, Thermostat, E-heater, Special Drain-pan		

1.Cooling and heating capacity, water flow and pressure drop data are based on high speed running of bare unit (i.e. without return air plenum).

2.Normal Operation:

- Cooling operation: inlet air dry/wet bulb temperature (°C): 27/19.5; water inlet/outlet temperature (°C): 7/12;
- Heating operation: inlet air dry bulb temperature (°C): 21; water inlet temperature (°C): 60; same water flow as cooling operation;

3.EarthWise Operation:

- Cooling operation: inlet air dry/wet bulb temperature (°C): 27/19.5; water inlet/outlet temperature (°C): 5/13;
- Heating operation: inlet air dry bulb temperature (°C): 21; water inlet temperature (°C): 60; same water flow as cooling operation;

4.High Capacity EarthWise operation:

- Cooling operation: inlet air dry/wet bulb temperature (°C): 26.7 °C/19.4 °C; water inlet/outlet temperature (°C): 7.2 °C/15.6 °C;
- Heating operation: inlet air dry bulb temperature (°C): 21; water inlet temperature (°C): 60; same water flow as cooling operation;

5. Same performance for EarthWise application.

6. High capacity EarthWise application data is based on medium speed. Other data is based on high speed.

Performance Data

4 Row Unit (2-Pipe) (12/30/50Pa Motor)

		02	03	04	05	06	08	10	12	14	
Air Flow	High Speed	340	510	680	850	1020	1360	1700	2040	2380	
	Middle Speed	280	410	550	690	830	1100	1360	1630	1900	
	Low Speed	180	270	350	440	520	690	860	1020	1190	
Normal Application	Cooling Capacity	kW	2.54	3.66	4.73	5.55	7.01	9.21	11.16	13.07	14.93
	Heating Capacity	kW	4.00	5.69	7.20	8.82	10.73	14.17	17.61	20.16	23.43
	Heating Capacity (by E-heater) ⁽⁵⁾	kW	0.50	1.00	1.40	1.60	1.80	2.80	3.20	3.60	4.60
	Water Flow	l/s	0.12	0.18	0.23	0.27	0.33	0.44	0.53	0.62	0.71
	Water Pressure Drop	kPa	16	20	30	30	34	35	40	40	50
EarthWise Application	Cooling Capacity	kW	2.47	3.56	4.58	5.60	7.24	8.79	10.76	13.05	15.17
	Heating Capacity	kW	3.76	5.40	6.72	8.43	10.37	13.35	16.64	18.87	21.79
	Water Flow	l/s	0.08	0.12	0.14	0.17	0.22	0.29	0.34	0.40	0.42
	Water Pressure Drop	kPa	16	30	28	24	40	40	40	40	50
Power Consumption	12Pa	220 ~ 240V/50Hz	26	39	45	68	96	115	152	189	228
		220 ~ 240V/60Hz	27	43	51	67	85	109	142	178	213
	30Pa	220 ~ 240V/50Hz	41	55	71	87	108	142	174	212	253
		220 ~ 240V/60Hz	36	49	62	87	88	119	163	193	311
	50Pa	220 ~ 240V/50Hz	48	64	84	99	118	158	210	230	290
		220 ~ 240V/60Hz	40	58	77	112	134	149	242	273	333
Noise	12Pa	dBA	34.5	35.5	36.5	40.5	45.0	44	46.5	49.0	51.0
	30Pa	dBA	38.0	40.0	41.5	43.5	46.0	46.5	49.0	51.0	53.0
	50Pa	dBA	41.0	42.5	45.0	47.0	48.0	49.0	51.0	52.0	54.0
Number of Motors			1	1	1	1	1	2	2	2	2
Working Pressure			1.8MPa								
Coil Type			Copper Tube / Hydrophilic Aluminum Fin								
Fan Type			Forward-Curve Centrifugal Fan								
Motor Type			Single-phase Permanent Split Capacitor								
Water Inlet/Outlet Diameter			Rc 3/4" (Female)								
Drain-pan Type			One-piece Stamping & Electrostatic Coating								
Drain-pan Connection Diameter			R 3/4"(Male)								
Options			Return Air Plenum, Filter, Thermostat, E-heater, Special Drain-pan								

1.Cooling and heating capacity, water flow and pressure drop data are based on high speed running of bare unit (i.e. without return air plenum).

2.Normal Operation:

- Cooling operation: inlet air dry/wet bulb temperature (°C): 27/19.5; water inlet/outlet temperature (°C): 7/12;
- Heating operation: inlet air dry bulb temperature (°C): 21; water inlet temperature (°C): 60; same water flow as cooling operation;

3.EarthWise Operation:

- Cooling operation: inlet air dry/wet bulb temperature (°C): 27/19.5; water inlet/outlet temperature (°C): 5/13;
- Heating operation: inlet air dry bulb temperature (°C): 21; water inlet temperature (°C): 60; same water flow as cooling operation;

4.Please refer to model number description for more options.

5. Same performance for EarthWise application.

4 Row Unit (2-Pipe, 100Pa Motor)

			11	13	15
Air Flow	High Speed	CMH	1870	2210	2550
	Middle Speed	CMH	1700	1870	2040
	Low Speed	CMH	935	1105	1275
Normal Application	Cooling Capacity	kW	11.83	13.81	15.58
	Heating Capacity	kW	18.72	21.43	24.51
	Heating Capacity (by E-heater) ⁽⁵⁾	kW	3.20	3.60	4.60
	Water Flow	l/s	0.56	0.66	0.74
	Water Pressure Drop	kPa	45	45	55
EarthWise Application	Cooling Capacity	kW	11.49	13.80	15.80
	Heating Capacity	kW	17.63	20.06	22.78
	Water Flow	l/s	0.34	0.39	0.44
	Water Pressure Drop	kPa	44	41	54
Power Consumption (220~240V/50Hz)	High Speed	W	296	303	376
	Medium Speed	W	254	286	312
	Low Speed	W	141	215	227
Power Consumption (220~240V/60Hz)	High Speed	W	319	359	400
	Medium Speed	W	296	318	354
	Low Speed	W	165	243	265
Noise	High Speed	dBA	56.0	57.0	58.0
	Medium Speed	dBA	55.0	55.5	55.5
	Low Speed	dBA	51.5	51.5	51.5
Number of Motors			2	2	2
Working Pressure			1.8MPa		
Coil Type			Copper Tube / Hydrophilic Aluminum Fin		
Fan Type			Forward-Curve Centrifugal Fan		
Motor Type			Single-phase Permanent Split Capacitor		
Water Inlet/Outlet Diameter			Rc 3/4" (Female)		
Drain-pan Type			One-piece Stamping & Electrostatic Coating		
Drain-pan Connection Diameter			R 3/4"(Male)		
Options			Return Air Plenum, Filter, Thermostat, E-heater, Special Drain-pan		

1.Cooling and heating capacity, water flow and pressure drop data are based on high speed running of bare unit (i.e. without return air plenum).

2.Normal Operation:

- Cooling operation: inlet air dry/wet bulb temperature (°C): 27/19.5; water inlet/outlet temperature (°C): 7/12;
- Heating operation: inlet air dry bulb temperature (°C): 21; water inlet temperature (°C): 60; same water flow as cooling operation;

3.EarthWise Operation:

- Cooling operation: inlet air dry/wet bulb temperature (°C): 27/19.5; water inlet/outlet temperature (°C): 5/13;
- Heating operation: inlet air dry bulb temperature (°C): 21; water inlet temperature (°C): 60; same water flow as cooling operation;

4.Please refer to model number description for more options.

5. Same performance for EarthWise application.

Performance Data

2 Row Unit (2-Pipe, 12/30/50Pa Motor)

		02	03	04	05	06	08		
Air Flow CMH	High Speed	350	520	690	870	1040	1380		
	Middle Speed	280	410	550	700	830	1100		
	Low Speed	180	270	350	450	520	690		
Cooling Capacity	kW	1.90	2.80	3.60	4.50	5.40	7.20		
Heating Capacity	kW	3.15	4.93	6.10	7.41	8.90	12.00		
Heating Capacity (by E-heater ^①)	kW	0.50	1.00	1.40	1.60	1.80	2.80		
Water Flow	l/s	0.10	0.14	0.17	0.21	0.26	0.34		
Water Pressure Drop	kPa	15	30	25	30	34	36		
Power Consumption	12Pa	220 ~ 240V/50Hz	W	26	39	45	68	96	115
				220 ~ 240V/60Hz	27	43	51	67	85
	30Pa	220 ~ 240V/50Hz	W	41	55	71	87	108	142
				220 ~ 240V/60Hz	36	49	62	87	88
	50Pa	220 ~ 240V/50Hz	W	48	64	84	99	118	158
				220 ~ 240V/60Hz	40	58	77	112	134
Noise	12Pa	dBA	34.5	35.5	36.5	40.5	45.0	44	
	30Pa		38.0	40.0	41.5	43.5	46.0	46.5	
	50Pa		41.0	42.5	45.0	47.0	48.0	49.0	
Number of Motors		1	1	1	1	1	2		
Working Pressure	1.8MPa								
Coil Type	Copper Tube / Hydrophilic Aluminum Fin								
Fan Type	Forward-Curve Centrifugal Fan								
Motor Type	Single-phase Permanent Split Capacitor								
Water Inlet/Outlet Diameter	Rc 3/4" (Female)								
Drain-pan Type	One-piece Stamping & Electrostatic Coating								
Drain-pan Connection Diameter	R 3/4" (Male)								
Options	Return Air Plenum, Filter, Thermostat, E-heater, Special Drain-pan								

1.Cooling and heating capacity, water flow and pressure drop data are based on high speed running of bare unit (i.e. without return air plenum).

2.Normal Operation:

- Cooling operation: inlet air dry/wet bulb temperature (°C): 27/19.5; water inlet/outlet temperature (°C): 7/12;

- Heating operation: inlet air dry bulb temperature (°C): 21; water inlet temperature (°C): 60; same water flow as cooling operation;

3.Please refer to model number description for more options.

4. Same performance for EarthWise application.

Airflow Curve(12/30/50Pa Motor)

220 ~ 240V-50Hz

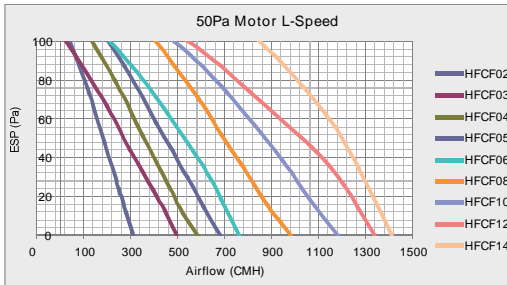
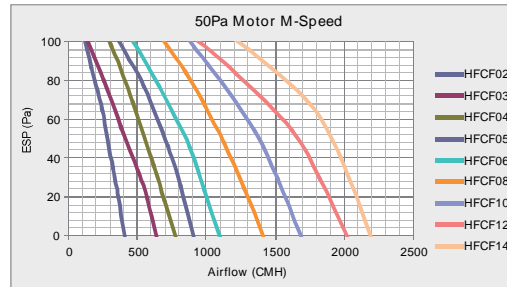
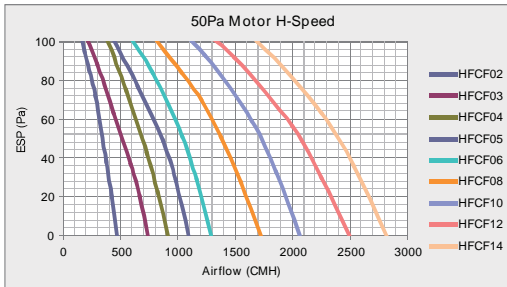
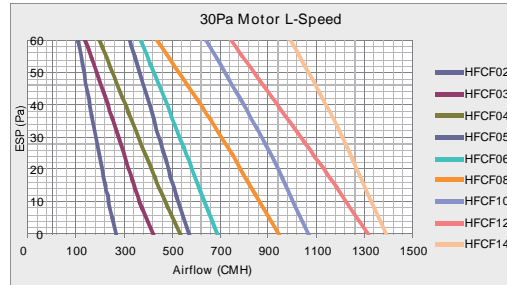
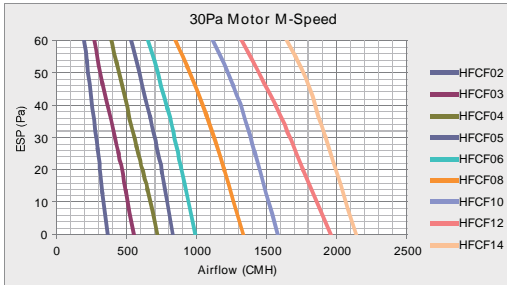
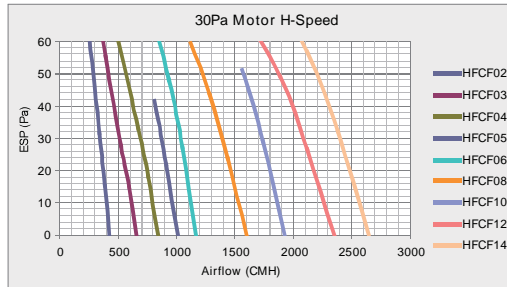
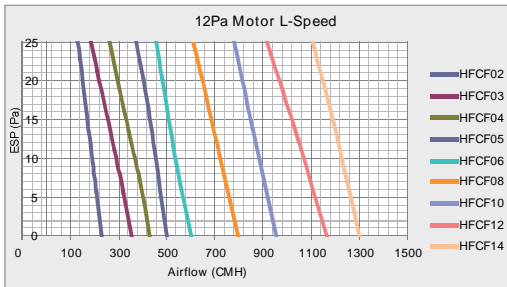
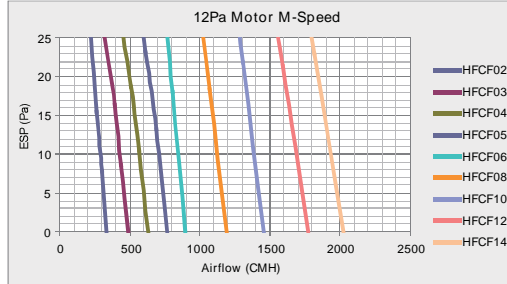
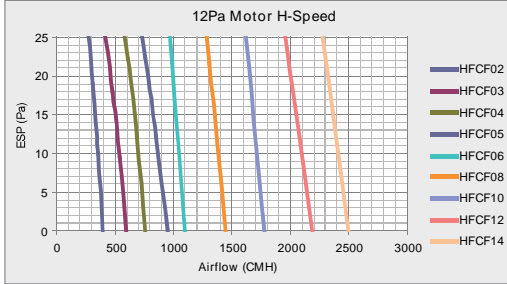

Airflow Curve(12/30/50Pa Motor)

220 ~ 240V-60Hz

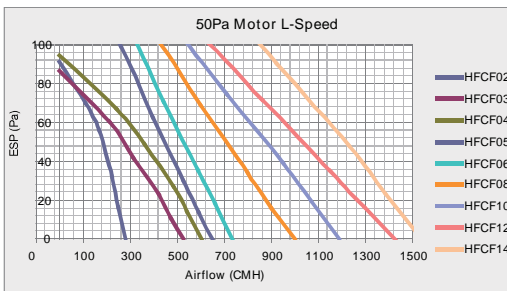
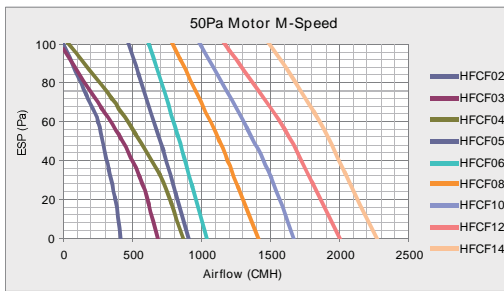
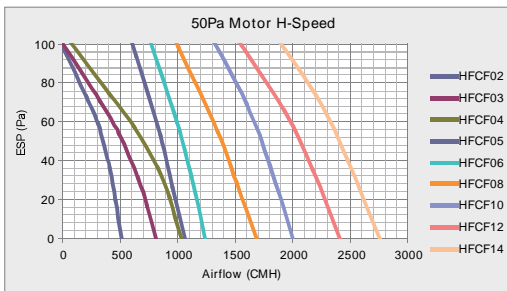
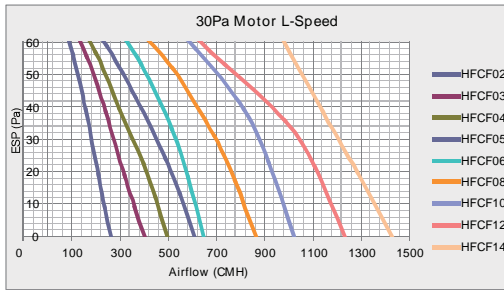
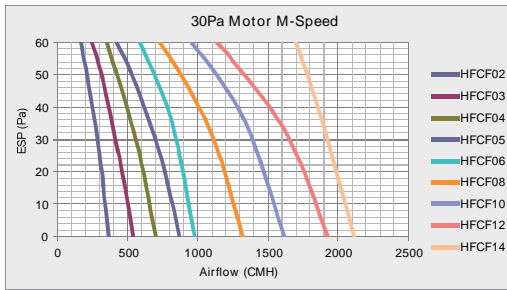
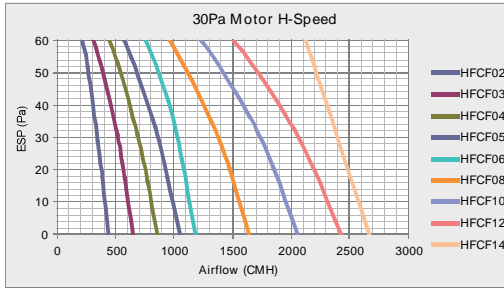
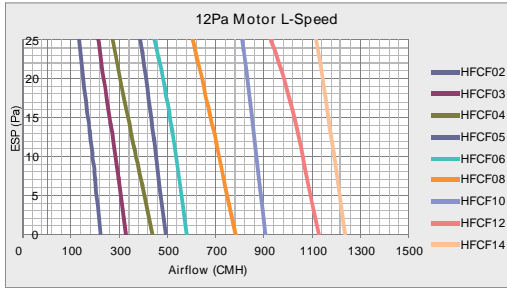
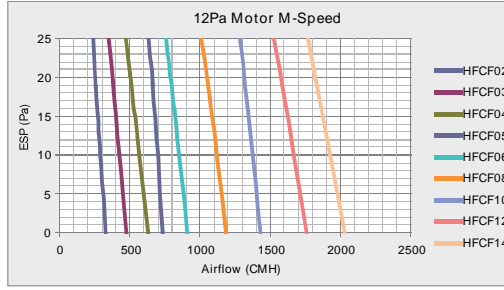
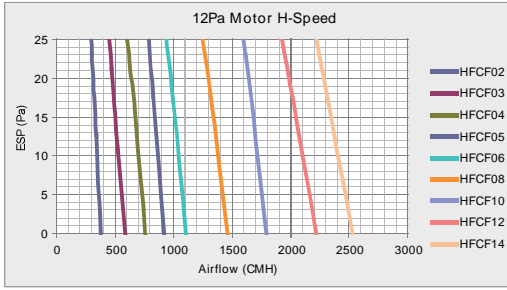

220 ~ 240V-60Hz

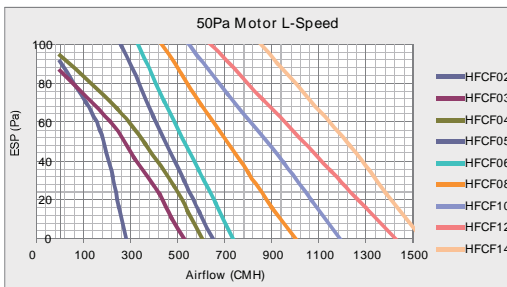
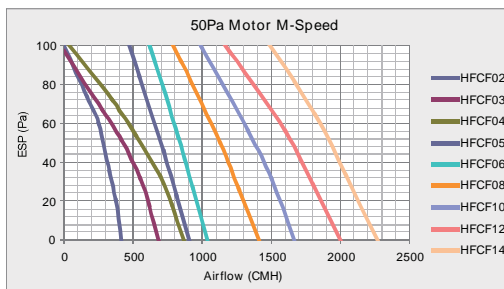
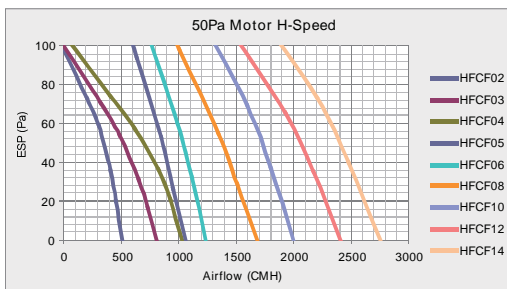
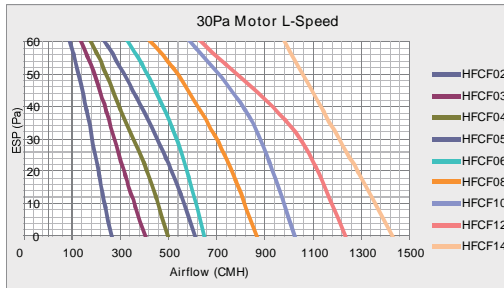
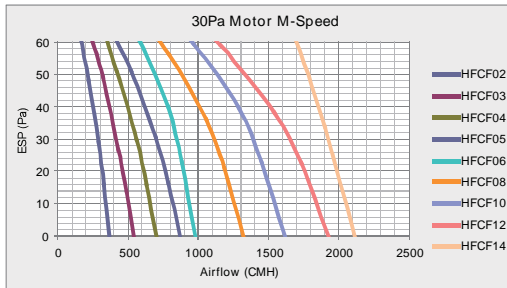
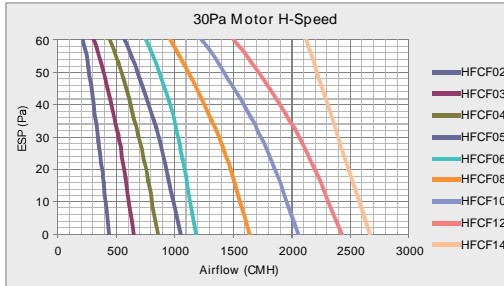
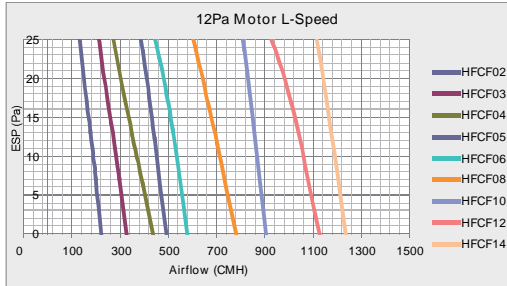
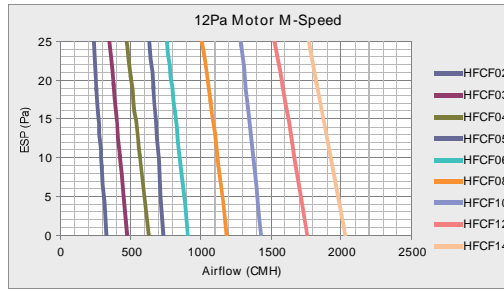
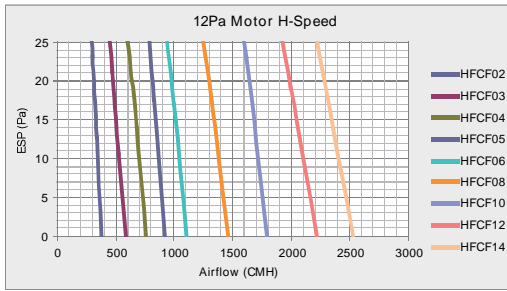

Wiring Diagram

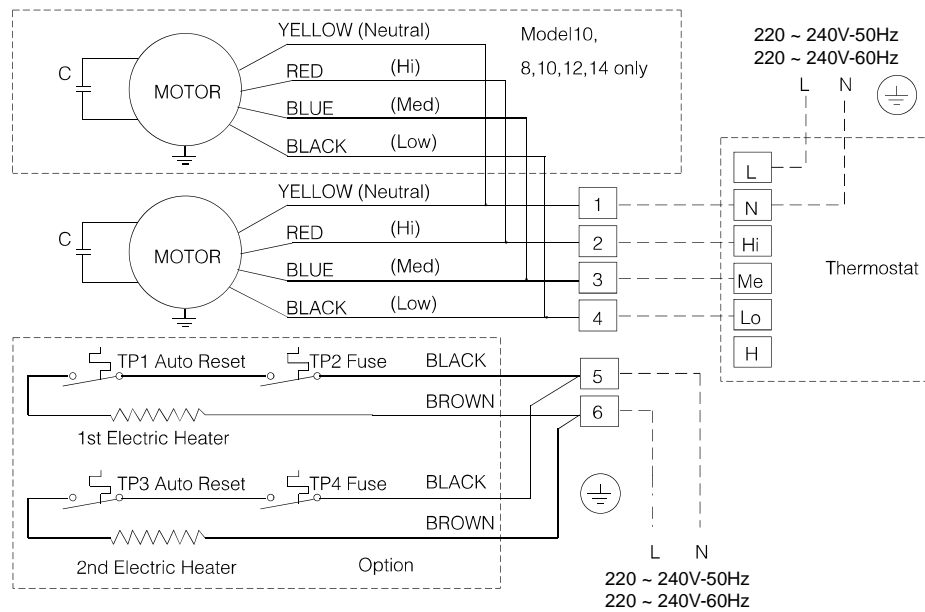

Motor speed control

Yellow and Red Wires = High Speed

Yellow and Blue Wires = Medium Speed

Yellow and Black Wires = Low Speed

Trane can provide terminal boxes with relay inside to support e-heater application and you can freely choose according to your needs.

Warning:

1. Units with different sizes or motor types are not allowed to be wired in parallel to be controlled by one thermostat.
2. Max. 2 units with same sizes and motor types may be wired in parallel to be controlled by one thermostat, provided that the thermostat capacity is large enough to control two units.
3. Only qualified personnel should install and service the equipment.
4. Cut off power before any service or maintenance starts.

Dimensions and Weights

2-pipe (without return plenum)

Unit:mm

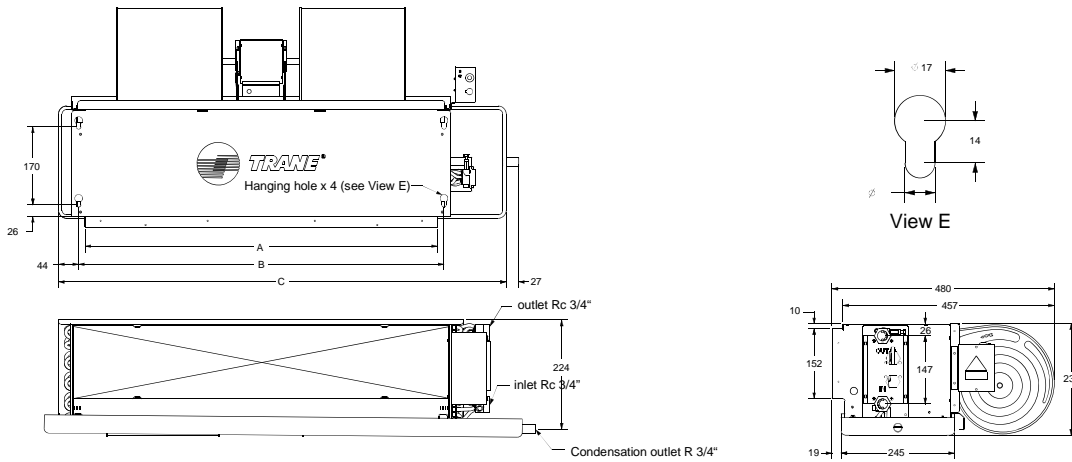

2-pipe (with return plenum)

Unit:mm

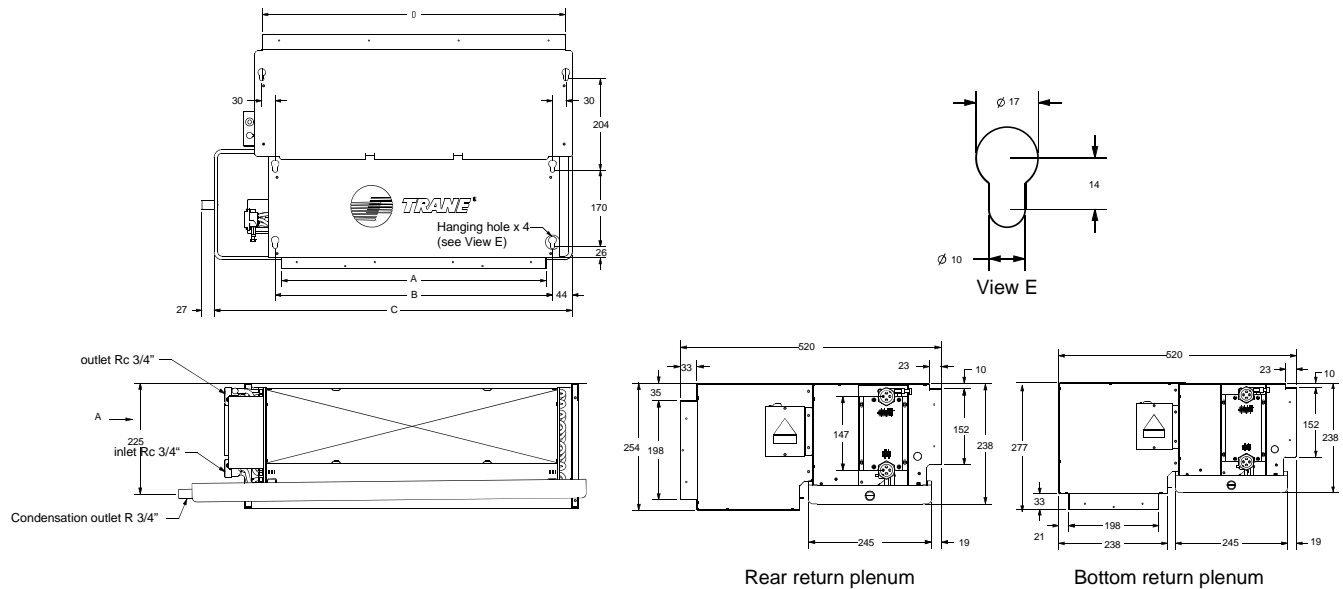

Dimension (mm)	Weight (kg)																			
	Without return plenum								With return plenum											
	A	B	C*	D	12Pa		30Pa		50Pa		12Pa		30Pa		50Pa					
				2 Row	3 Row	4 Row	2 Row	3 Row	4 Row	2 Row	3 Row	4 Row	2 Row	3 Row	4 Row	2 Row	3 Row	4 Row		
HFCF02	440	468	648	526	10	11	11	10.5	11	11	10.5	11	11.5	13.5	14	14	13.5	14	14	
HFCF03	590	618	798	676	13	14	14	13	14	14	13.5	14	14	17	17.5	17.5	17	17.5	17.5	
HFCF04	690	718	898	776	15	15	16	15	15.5	16	15	15.5	16	19	19.5	20.5	19	19.5	20	
HFCF05	770	798	978	856	15.5	16	17	16	17	17	16	17	17.5	19.5	20	21	20	20.5	20.5	
HFCF06	970	998	1183	1056	18.5	19	21	19	20	21	19	20	21	23.5	24	25	23.5	24	25	
HFCF08	1210	1238	1423	1296	26	27	28	26	27	28	26.5	27	28	32	33	34	32	33	34	
HFCF10	1330	1358	1543	1416	-	31	32	-	31	32	-	31	32	-	37.5	38.5	37.5	38.5	37.5	
HFCF12	1570	1598	1783	1656	-	34	35	-	34	35	-	34	35	-	41.5	42.5	42	43	42	
HFCF14	1750	1778	1963	1836	-	36	37.5	-	36.5	37.5	-	36.5	38	-	44.5	45.5	45	46	45	
					100Pa								100Pa							
					3 Row				4 Row				3 Row				4 Row			
HFCF11	1330	1358	1543	1416	33				34				39.5				40.5			
HFCF13	1570	1598	1783	1656	36				36.5				44				45			
HFCF15	1750	1778	1963	1836	37.5				39				46				47.5			

Note:
 C dimension is standard drain pan length.
 Add 200 to C dimension to get +200mm extended drain pan length.
 Add 310 to C dimension to get +310mm extended drain pan length.

Trane - byTraneTechnologies (NYSE:TT), a global climate innovator - creates comfortable, energy efficient indoor environments for commercial and residential applications. For more information, please visit trane.com or tranetechnologies.com.

Trane has a policy of continuous product and product data improvement and reserves the right to change design and specifications without notice. We are committed to using environmentally conscious print practices.